



DISCOUNT  
MARKETING  
PRODUCTS



50398



49891



582106



469749



# CATALOG 2024

The fabric of our success.





# The DMP Difference.

Welcome to DMP, your premier supplier of marketing display products designed for distributors across the United States. At DMP, we don't just offer marketing display products; we deliver exceptional value and unmatched flexibility.

## Who are we?

### Our Commitment

Our mission is clear: to provide the promotional industry's best value for marketing display products. DMP specializes in customization and quick delivery of custom-designed and hard-to-find event display products. With our vast network of resources and a team of experts, we tailor every product to your unique needs and requirements.

### A Partner You Can Trust

DMP is more than just a supplier; we're your dependable marketing partner. Whether you need assistance with ideation, executing marketing plans on a budget, or simply want a hassle-free ordering experience, we're here to help.

### Exclusively for Distributors

Our comprehensive product line of event display products is exclusively available through our network of qualified distributors and resellers. We focus solely on custom-printed, fabric marketing products, ensuring you receive the highest quality at the most affordable prices.

Choose DMP as your marketing partner and experience the difference. We're committed to delivering consistent quality, competitive pricing, unparalleled reliability, and fairness. Your success is our success.

## Why Choose DMP?

**Expertise in Fabric-Based Marketing Products:** We specialize in full-color, full-coverage print on a wide range of fabric options. Our products feature dye sublimation or digital printing, custom sizes, and shapes, and have no minimum order requirements.

**Simplified Pricing:** With DMP, you'll find transparent and competitive pricing. We believe in offering high-quality products at the most affordable prices.

**On-Time Delivery Guarantee:** We understand the importance of meeting deadlines. That's why we offer an on-time delivery guarantee, ensuring your projects are always on schedule.

**Fulfillment and Drop Ship Services:** Our services go beyond product manufacturing. We provide fulfillment and drop ship services to simplify your logistics.

**Free Artwork Setup:** We offer free artwork setup for all orders, making your customization process hassle-free.

**Virtual Proofs:** Our virtual proofs include flat and 3D images, allowing you to visualize your product before production.

**Spec Samples:** We provide applicable spec samples for both production and generic needs, ensuring your products meet your exact specifications.

# BEST SELLERS



## NEW PRODUCTS



**MONOPAD DISPLAY**  
PAGE 51



**SAFETY VEST**  
PAGE 62



**ARCH DISPLAY**  
PAGE 59



**PORTABLE BEACH TENT**  
PAGE 61



**BARRIER COVER**  
PAGE 54



**SEG LIGHT BOX**  
PAGE 56



**5X5' TENT**  
PAGE 6



# INDEX

Custom Tents . . . . .	1
Table covers . . . . .	13
Feather Flags . . . . .	22
Custom Banners . . . . .	27
Custom Flags . . . . .	30
Car Products . . . . .	37
Custom Displays . . . . .	39
Promotional Products . . . . .	59
Display Kits . . . . .	63





# CUSTOM TENTS





# Standard Tent Sizes

Our standard tent sizes include 10x10' (steel or aluminum frame), 10x15', and 10x20' (aluminum only).

## 10x10ft

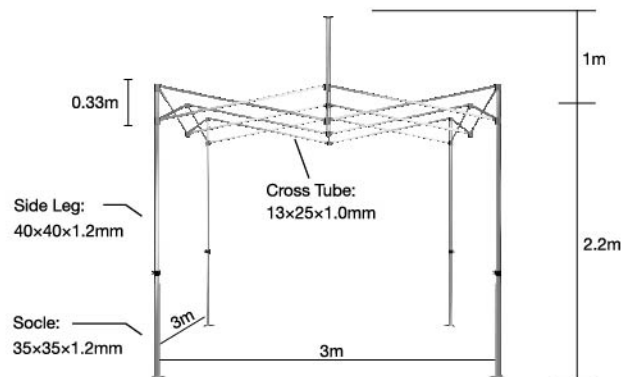

- Available as a 30mm black or white steel frame, 40mm or 50mm Hex aluminum frame
- Full color dye sublimation printing with PMS color matching
- 600D Polyurethane coated polyester (*Swatch Booklet pg 1*)



### Deluxe White Steel Frame

- 30mm (1.25") steel post
- 1.2mm gauge
- ABS nylon connectors
- Scratch & chip resistant



### Deluxe Black Steel Frame

- 30mm (1.25") steel post
- 1.2mm gauge
- ABS nylon connectors
- Scratch & chip resistant



### Hexagonal Aluminum Frame

- 40mm & 50mm (1.75" & 2") frame
- 1.2mm, 1.5mm, or 2.0mm gauge
- Anodized aluminum frames
- Industrial strength





## Frame Details



**Clip Latch**  
Steel and Hex Frame



**ABS Nylon Connector**  
Steel and Hex Frame



**Steel Support Pad**  
Hex Frame Only



**Hinge Latch**  
Steel and Hex Frame

## Canopy Details



**Velcro Connection**



**D-Ring**



**Hook**

## Quick & Easy Setup

1.



2.



3.



4.

1. Open frame
2. Hang fabric over frame
3. Secure to velcro pad and tighten frame
4. BE PROUD!

# Standard Tent Sizes

## 10x15ft

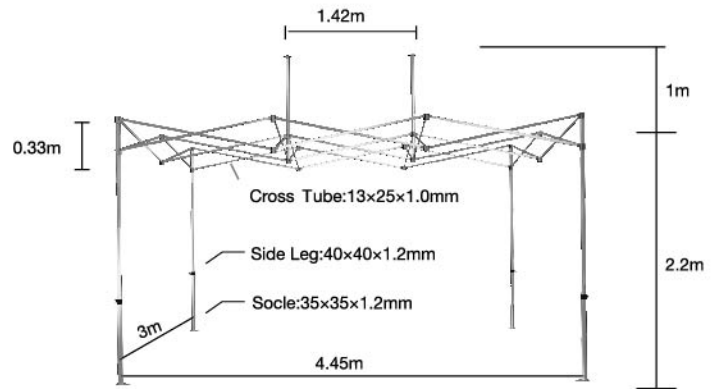

## 10x20ft

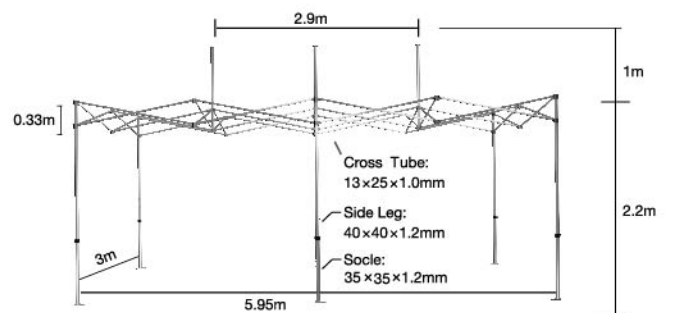



## Tent Options

Additional tent packages below apply to all tent sizes and frame types.



### Frame + Canopy + Full Wall + 2pcs Half Side Walls + Wheel Carry Bag

- Available as 40mm Hex aluminum frame
- Full color dye sublimation printing with PMS color matching
- 600D Polyurethane coated polyester (*Swatch Booklet pg 1*)

### Frame + Canopy + Full Wall + Wheel Carry Bag

- Available as 40mm Hex aluminum frame
- Full color dye sublimation printing with PMS color matching
- 600D Polyurethane coated polyester (*Swatch Booklet pg 1*)



### Frame + Canopy + 2pcs Half Side Walls + Wheel Carry Bag

- Available as 40mm Hex aluminum frame
- Full color dye sublimation printing with PMS color matching
- 600D Polyurethane coated polyester (*Swatch Booklet pg 1*)



# ADDITIONAL SIZE OPTIONS

Subject to availability, please inquire for further details.



◀ 5x5' Hex Aluminum Frame Tent (40mm)

6.5x6.5' Hex Aluminum Frame Tent (40mm) ▶



13x13' Hex Aluminum Frame Tent (50mm)



13x20' Hex Aluminum Frame Tent (50mm)



13x26' Hex Aluminum Frame Tent



20x20' Hex Aluminum Frame Tent (50mm)





# TENTS



## Hex Aluminum Frame Options

All tent frame options are not only simple to setup, but also allow for easy removal and replacement of damaged components.

**Standard: 40mm Hex Post**  
**Premium: 50mm Hex Post**

### Available Sizes:

5'x5'	10'x15'	13'x20'
6.5'x6.5'	10'x20'	13'x26'
10'x10'	13'x13'	20'x20'

## Standard 40mm VS Premium 50mm

Specification\Type	40mm Hex Frame (1.2mm) (5x5/6.5x6.5/10x10/10x15/10x20)	50mm Hex Frame (2mm) (10x10/10x15/10x20)	50mm Hex Frame (1.8mm) (13x13/13x20/13x26/20x20)
<b>Material</b>	Aluminum		
<b>Leg Shape</b>	Hexagonal		
<b>Details of Leg</b>	 <p>40mm Thickness : 1.2mm</p>	 <p>50mm Thickness : 2mm</p>	 <p>50mm Thickness : 1.8mm</p>
<b>Diameter</b>	40mm	50mm	50mm
<b>Thickness</b>	1.2mm	2mm	1.8mm

# Full & Half Wall Options

Full walls and half walls can be added to any available tent frame option. These walls include various options such as single or double sided print, PVC windows, and access zippers.



## Full Wall

- Full color dye sublimation printing with PMS color matching
- 600D Polyurethane coated polyester (*Swatch Booklet pg 1*)
- Applicable to the tent frame options below:

**Size:**

5'x5'	10'x15'	13'x20'
6.5'x6.5'	10'x20'	13'x26'
10'x10'	13'x13'	20'x20'



## Half Wall

- Full color dye sublimation printing with PMS color matching
- 600D Polyurethane coated polyester (*Swatch Booklet pg 1*)
- Single- or double-sided print
- Applicable to the following tent side lengths:

**Length:**

5FT	6.5FT
10FT	13FT
20FT	



## Full Wall w/ Zipper

- Full color dye sublimation printing with PMS color matching
- 600D Polyurethane coated polyester (*Swatch Booklet pg 1*)
- Single- or double-sided print
- Zipper placement can vary (center, left side, right side)
- Applicable to the tent frame options below:

**Size:**

5'x5'	10'x15'	13'x20'
6.5'x6.5'	10'x20'	13'x26'
10'x10'	13'x13'	20'x20'





## Full & Half Wall Options



### Full Wall w/ Single PVC Window

- Full color dye sublimation printing with PMS color matching
- 600D Polyurethane coated polyester (*Swatch Booklet pg 1*)
- Single- or double-sided print
- Clear PVC window
- Applicable to the tent frame options below:

**Size:**  
 10'x10'  
 10'x15'  
 10'x20'



### Full Wall w/ Double PVC Window

- Full color dye sublimation printing with PMS color matching
- 600D Polyurethane coated polyester (*Swatch Booklet pg 1*)
- Single- or double-sided print
- Clear PVC windows
- Applicable to the tent frame options below:

**Size:**  
 10'x10'  
 10'x15'  
 10'x20'



### Half Wall Support Hardware

- Aluminum pole with clamps to support half wall fabric
- Applicable to the tent frame options below:

**Length:**  
 5FT    6.5FT  
 10FT   13FT

# Tent Add-Ons

Incorporate these add-ons and differentiate your tent from the others, while also increasing your branding and messaging visibility.



## Square Billboard Banner

- Single-sided full color dye sublimation printing
- 7oz stretch polyester (*Swatch Booklet* pg 5)
- Complete unit includes fabric, pole, and brackets
- Fabric size: 96"x24"
- Only applicable to the 10ft side of a Hex frame tent



## Curved Billboard Banner

- Single-sided full color dye sublimation printing
- 7oz stretch polyester (*Swatch Booklet* pg 5)
- Complete unit includes fabric, pole, and brackets
- Size: 90"x42"
- Only applicable to the 10ft side of a Hex frame tent



## Tent Awning

- Single-sided full color dye sublimation printing
- 600D Polyurethane coated polyester (*Swatch Booklet* pg 1)
- Complete unit includes fabric, pole, and brackets
- Fabric and frame size: 116"x36"
- Only applicable to the 10ft side of a Hex frame tent



## Valance Banner

- Single-sided full color dye sublimation printing
- 600D Polyurethane coated polyester (*Swatch Booklet* pg 1)
- 600D PU Fluorescent Yellow (*Swatch Booklet* pg 20)
- Applicable to various lengths:  
5ft 6.5ft 10ft 13ft 15ft 20ft 26ft



# TENTS



## Tent Ceiling Banner

- Single-sided full color dye sublimation printing
- 7oz stretch polyester (*Swatch Booklet* pg 5)
- Applicable to the following tent sizes:  
10'x10', 10'x15', and 10'x20'



## Tent Post Feather Flag



- Applicable to all tents frames, Hex or square posts
- Double-sided Convex flag
- 100D polyester w/ blockout (*Swatch Booklet* pg 30)
- Complete unit includes fabric, pole, and brackets
- Size: 9ft and 12ft feather flag options



## Tent Peak Flag

- Mounts to 10x10' Hex Frame Tent only
- Double-sided
- 100D polyester w/ blockout (*Swatch Booklet* pg 30)
- Complete unit includes fabric, pole, and brackets
- *Tent canopy w/ peak hole is required*



## Tent Leg Cover

- Includes 4 total, one for each leg
- 600D Polyurethane coated polyester (*Swatch Booklet* pg 1)
- Size: 60"x88"
- Simple velcro strap attachment
- Applicable to all tent frame options





# Tent Accessories



## Wheeled Carry Bag

- Included with all tent kits

## Rope & Ground Spike

- This accessory can be used for all tent sizes



## Sand Bags

- Used for additional weight, applicable to any tent size



## Canopy Bag

- Used as additional storage for canopy only
- Supports the following canopy sizes:  
5x5' 6.5'x6.5' 10'x10' 10'x15' 10'x20'



## Tent Post Feather Flag Bracket

- Used to support feather flag options
- Applicable to Hex and square frame posts

# TABLE COVERS





# Fabric & Material

## Fabric Options w/ Dye Sublimation Print:

- **Econ Fabric:** 7oz Wrinkle-resistant 300D Polyester, *Swatch Booklet pg 4*
- **Standard Fabric:** Wrinkle-resistant & Flame Retardant 300D Polyester, *page 2*
- **Stain-Resistant Fabric:** 7oz Stain-resistant 300D Polyester, *page 3*
- **Premium Fabric:** 9oz Flame-retardant Soft Knit, *page 9*
- **Stretch-Elastic Polyester:** Available in 7oz (Econ, Standard, or Stain-resistant) and 9oz Premium, see *pages 5, 6, 7, 8*



Rubber Fabric Protector

## All Material:

- Machine-washable
- Full coverage, full color dye sublimation print
- Suitable for indoor and outdoor use
- PMS color match w/ logo in multiple locations
- Custom backgrounds
- Wrinkle-resistant fabrics



Clear PVC Carry Bag w/ Zipper



Double-Edge Stitching

Price is determined only by the table cover size. Choose any style, artwork and rear finish at no additional cost.

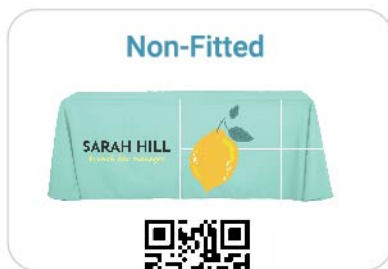

Non-Fitted



Rear Finish Options:



Closed Back

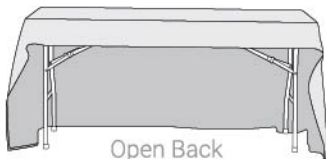

Open Back



Rear Zipper



Fitted



Rear Finish Options:

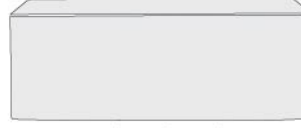

Closed Back

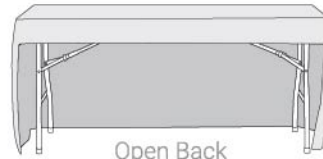

Open Back

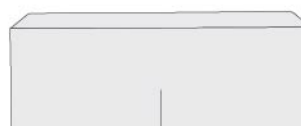

Rear Zipper



Fitted Stretch



Rear Finish Options:



Closed Back

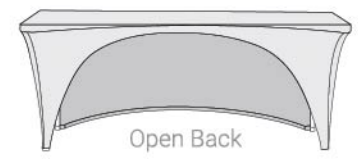

Open Back

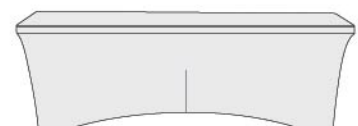

Rear Zipper



## Non-Fitted Table Covers



This loose-fitting table cover has draped corners, offering a classic look.

- Standard sizes to fit 4' (48"x24"/30"x29"), 6' (72"x30"x29"), and 8' (96"x30"x29") tables
- Custom sizing is also available with no minimums, please inquire
- Full color dye sublimation printing with PMS color matching



**Non-Fitted w/ Full Back**

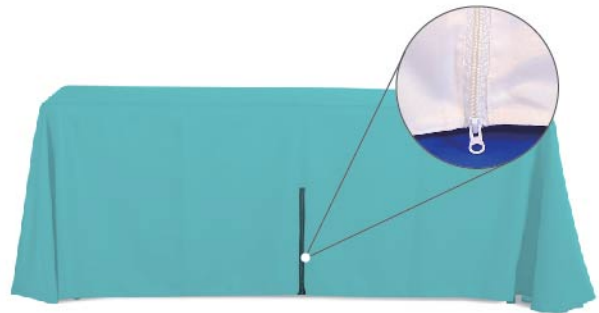

**Non-Fitted w/ Rear Zipper**



**Non-Fitted w/ Open Back**

### Fabric Options:

- Econ Fabric: 7oz Wrinkle-resistant 300D Polyester, *Swatch Booklet pg 4*
- Standard Fabric: Wrinkle-resistant & Flame Retardant 300D Polyester, *Swatch Booklet pg 2*
- Stain-Resistant Fabric: 7oz Stain-resistant 300D Polyester, *Swatch Booklet pg 3*
- Premium Fabric: 9oz Flame-retardant Soft Knit, *Swatch Booklet pg 9*

# Convertible Table Covers



## Convertible Table Covers

This versatile table cover is ideal for varying events and display options, providing a good fit on 8ft, 6ft and 4ft tables. The 8ft non-fitted style can convert to a 6ft fitted or non-fitted version, and the 6ft non-fitted style adjusts to a 4ft fitted or non-fitted version, eliminating the need to purchase two covers.

- Available as 6ft to 4ft, and 8ft to 6ft
- Full color dye sublimation printing with PMS color matching

## Fabric Options:

- Econ Fabric: 7oz Wrinkle-resistant 300D Polyester, *Swatch Booklet pg 4*
- Standard Fabric: Wrinkle-resistant & Flame Retardant 300D Polyester, *Swatch Booklet pg 2*
- Stain-Resistant Fabric: 7oz Stain-resistant 300D Polyester, *Swatch Booklet pg 3*
- Premium Fabric: 9oz Flame-retardant Soft Knit, *Swatch Booklet pg 9*

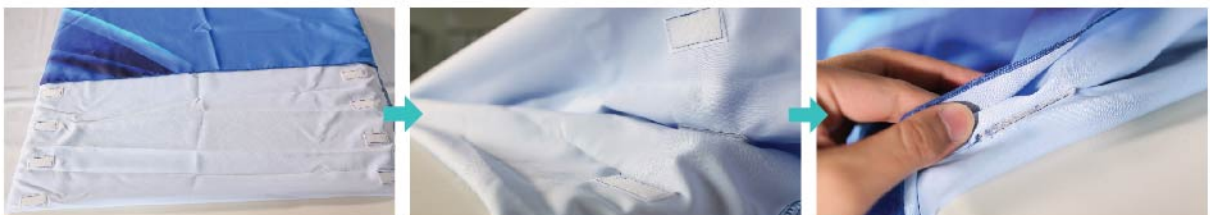
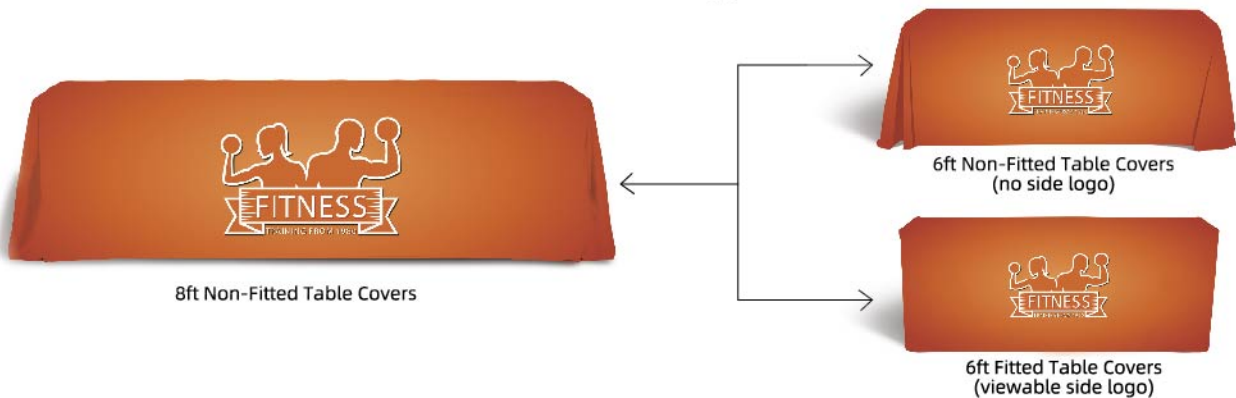



## Table Runners



Table runners are a simple and inexpensive alternative to full table covers. This is an ideal way to feature your customized brand and message with style at an affordable price.



- Standard sizes to fit 30"x88", 36"x88", and 42"x88"
- Custom sizing is also available with no minimums, please inquire
- Full color dye sublimation printing with PMS color matching

### Fabric Options:

- Econ Fabric: 7oz Wrinkle-resistant 300D Polyester, *Swatch Booklet pg 4*
- Standard Fabric: Wrinkle-resistant & Flame Retardant 300D Polyester, *Swatch Booklet pg 2*
- Stain-Resistant Fabric: 7oz Stain-resistant 300D Polyester, *Swatch Booklet pg 3*
- Premium Fabric: 9oz Flame-retardant Soft Knit, *Swatch Booklet pg 9*

## Round/Square Table Covers

These loosely-draped and seamless table covers work for round or square table tops. Standard and custom sizes are available.

- Standard size 59"x59"
- Custom sizing available upon request
- Full color dye sublimation printing with PMS color matching



Round Table Covers



Square Table Covers

### Fabric Options:

- Econ Fabric: 7oz Wrinkle-resistant 300D Polyester, *Swatch Booklet pg 4*
- Standard Fabric: Wrinkle-resistant & Flame Retardant 300D Polyester, *Swatch Booklet pg 2*
- Stain-Resistant Fabric: 7oz Stain-resistant 300D Polyester, *Swatch Booklet pg 3*
- Premium Fabric: 9oz Flame-retardant Soft Knit, *Swatch Booklet pg 9*

# Fitted Table Covers



This snug-fitting table cover conceals all four sides, offering a clean and tailored look.

- Standard sizes to fit 4' (48"x24"/30"x29"), 6' (72"x30"x29"), and 8' (96"x30"x29") tables
- Custom sizing is also available with no minimums, please inquire
- Full color dye sublimation printing with PMS color matching



Fitted w/ Open Back



Fitted w/ Full Back



Fitted w/ Zipper or Velcro Back

## Fabric Options:

- Econ Fabric: 7oz Wrinkle-resistant 300D Polyester, *Swatch Booklet pg 4*
- Standard Fabric: Wrinkle-resistant & Flame Retardant 300D Polyester, *Swatch Booklet pg 2*
- Stain-Resistant Fabric: 7oz Stain-resistant 300D Polyester, *Swatch Booklet pg 3*
- Premium Fabric: 9oz Flame-retardant Soft Knit, *Swatch Booklet pg 9*



## Pleated Table Covers



Corner Detail

This table cover is a hybrid fit incorporating the non-fitted and fitted style. The table cover is structured and fitted with draped corners.

- Standard size is 6ft and 8ft
- Full color dye sublimation printing with PMS color matching



### Fabric Options:

- Econ Fabric: 7oz Wrinkle-resistant 300D Polyester, *Swatch Booklet pg 4*
- Standard Fabric: Wrinkle-resistant & Flame Retardant 300D Polyester, *Swatch Booklet pg 2*
- Stain-Resistant Fabric: 7oz Stain-resistant 300D Polyester, *Swatch Booklet pg 3*
- Premium Fabric: 9oz Flame-retardant Soft Knit, *Swatch Booklet pg 9*

## Round Fitted Table Covers

The fitted structure of this table cover creates a defined round shape, which will highlight the table. Standard and custom sizes are available.

- Standard sizes: 24"x29", 32"x29", 32"x43", 60"x29"
- Custom sizing available upon request
- Full color dye sublimation printing with PMS color matching



Round Fitted Table Cover

### Fabric Options:

- Econ Fabric: 7oz Wrinkle-resistant 300D Polyester, *Swatch Booklet pg 4*
- Standard Fabric: Wrinkle-resistant & Flame Retardant 300D Polyester, *Swatch Booklet pg 2*
- Stain-Resistant Fabric: 7oz Stain-resistant 300D Polyester, *Swatch Booklet pg 3*
- Premium Fabric: 9oz Flame-retardant Soft Knit, *Swatch Booklet pg 9*

# Fitted Stretch Table Covers



This fitted elastic table cover conceals all four sides, offering a tight, form-fitting look, and secures the fabric under table legs.

- Standard sizes to fit 4' (48"x24"/30"x29"), 6' (72"x30"x29"), and 8' (96"x30"x29") tables
- Custom sizing is also available with no minimums, please inquire
- Full color dye sublimation printing with PMS color matching



Stretch Fitted w/ Open Back



Stretch Fitted w/ Full Back

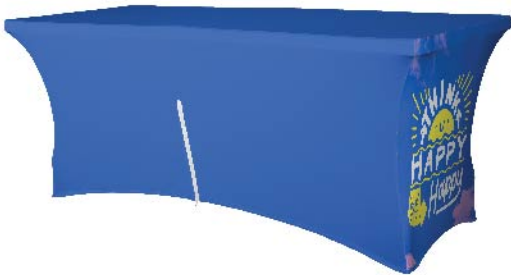

Stretch Fitted w/ Zipper or Velcro Back



Side View

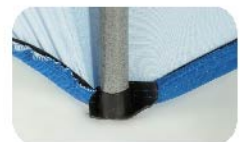

Rubber Fabric Protector

## Fabric Options:

- Econ Fabric: 7oz Stretch Polyester, *Swatch Booklet pg 5*
- Standard Fabric: 7oz Flame-retardant Stretch Polyester, *Swatch Booklet pg 6*
- Stain-Resistant Fabric: 7oz Stain-resistant Stretch Polyester, *Swatch Booklet pg 7*
- Premium Fabric: 8oz Flame-retardant Stretch Polyester, *Swatch Booklet pg 8*

# FITTED STRETCH TABLE COVERS



## Crossover Stretch Table Cover

This product is made from two individual covers that overlap allowing for alternate looks depending on which throw is placed on top.

- Standard sizes include 4ft, 6ft, and 8ft
- Full color dye sublimation printing with PMS color matching

### Fabric Options:

- Standard Fabric: 7oz Flame-retardant Stretch Polyester, *Swatch Booklet pg 6*
- Stain-Resistant Fabric: 7oz Stain-resistant Stretch Polyester, *Swatch Booklet pg 7*



## Round Stretch Table Cover

These round stretch table covers create a unique structure that helps your message stand out.

- Standard sizes include 24"x29", 32"x29", and 32"x43"
- Custom sizing is also available with no minimums, please inquire
- Full color dye sublimation printing with PMS color matching

### Fabric Options:

- Standard Fabric: 7oz Flame-retardant Stretch Polyester, *Swatch Booklet pg 6*
- Stain-Resistant Fabric: 7oz Stain-resistant Stretch Polyester, *Swatch Booklet pg 7*



## Round Table Topper

This is the ideal product to instantly transform a tabletop into a marketing opportunity.

- Full color dye sublimation printing with PMS color matching
- Round table topper sizes: 31" dia, 38" dia
- Rectangle table topper sizes: 48"x24", 48"x30", 72"x30", 96"x30"
- Custom sizes available upon request

### Fabric Options:

- Standard Fabric: 7oz Flame-retardant Stretch Polyester, *Swatch Booklet pg 6*
- Stain-Resistant Fabric: 7oz Stain-resistant Stretch Polyester, *Swatch Booklet pg 7*



## Rectangle Table Topper





# FEATHER FLAGS





# FEATHER FLAGS

Add custom feather flags to any marketing display collection to draw customer attention, near and far! These flags heighten brand recognition and increase revenue. Our custom feather flags are lightweight, portable and easy to assemble and disassemble.

## Product Features:

- Full-color digital printing
- PMS color match
- Reinforced webbing pole pockets for maximum durability
- Strong and flexible carbon fiber poles with premium carry bag included
- Various sizes and shapes available
- Single- and double-sided options where applicable
- Various base options available
- Lifetime warranty on all hardware options

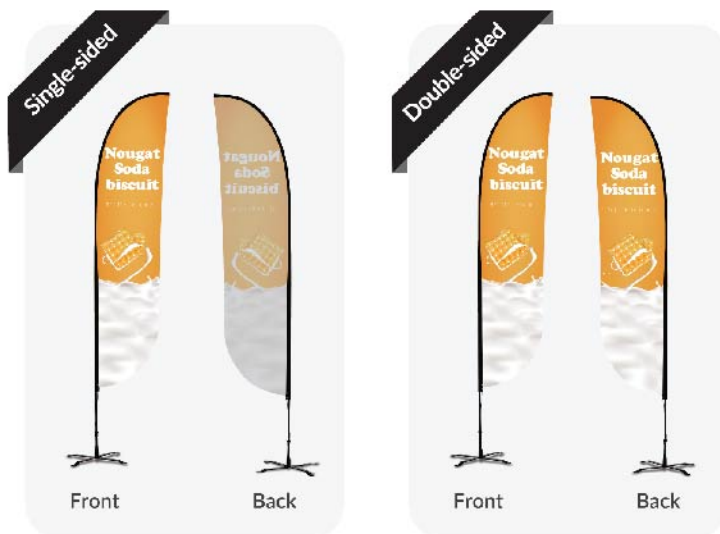
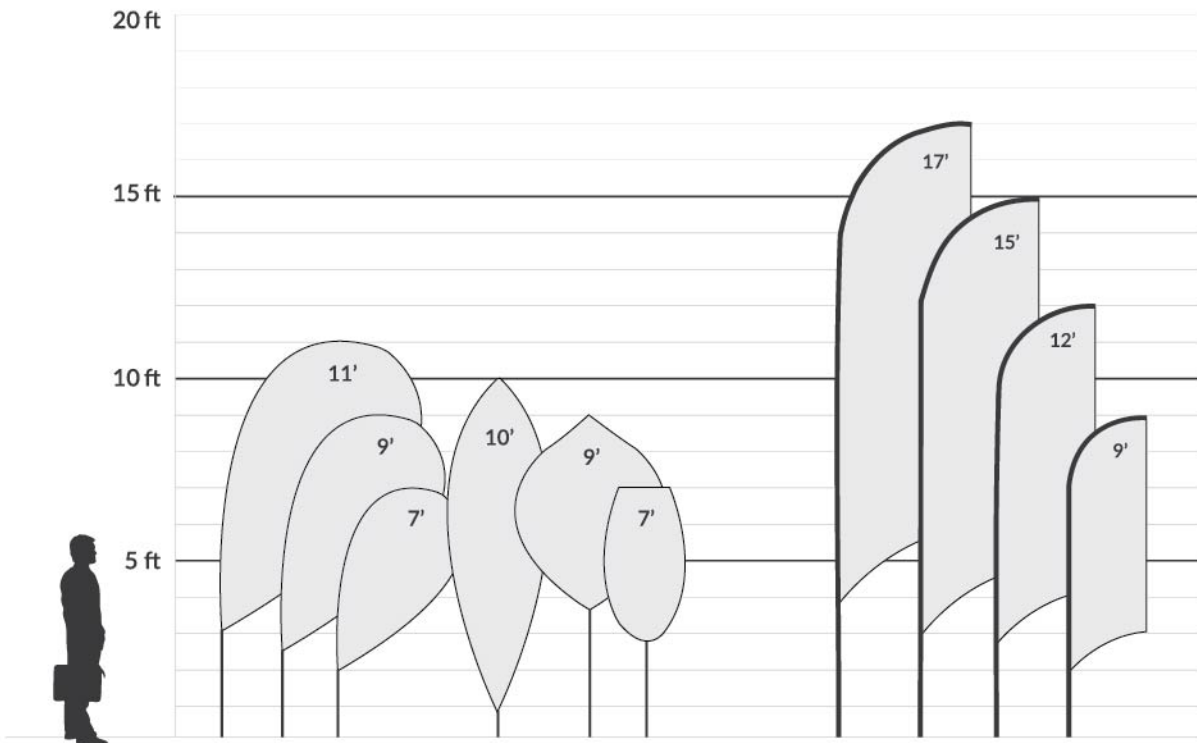

- Available as single-sided or double-sided print
- Single-sided fabric is an open-weave 110g knitted polyester (80% reverse bleed)
- Double-sided includes a block-out inner liner and two printed outer layers using a 100D polyester fabric
- Full-color printing allows for custom designs and PMS color matching
- Printed with premium UV inks to limit fading
- Chrome plated carbon steel base options with ball bearings to turn with the wind
- **LIFETIME WARRANTY** on banner poles and bases \*
- Fabric: 6 to 12 months warranty against fading, dependent on environmental conditions
- \* **Warranty does not include negligence**

**Double-sided includes a blockout middle layer, which allows for a different design on each side.**

# Feather Flags



Blade



Convex

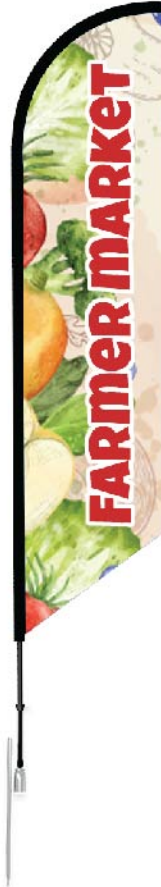

Angled



Concave

## Blade / Convex / Angled / Concave

- Single or double-sided
- Available as 9ft (Fabric size: 26"x79"), 12ft (Fabric size: 28"x118"), 15ft (Fabric size: 32"x149"), and 17ft (Fabric size: 34"x172")
- Complete unit includes printed fabric, pole, and support base

### Fabric Options:

- Single-sided: 110g knitted polyester (80% reverse bleed), *Swatch Booklet pg 29*
- Double-sided: 100D Polyester, *Swatch Booklet pg 30*
- Duplex\* Printed 115g Knitted Polyester (100% reverse bleed, single-ply fabric w/ mirror image), *Swatch Booklet pg 25*
- Duplex\* Printed 100D Polyester (100% reverse bleed, single-ply fabric w/ mirror image), *Swatch Booklet pg 26*
- Duplex\* Printed Blockout Polyester (single-ply, 2 sided print w/ independent images), *Swatch Booklet pg 24*



Flexible Top Pole



Bungee Cord w/ Grommets

\*Additional costs apply



# FEATHER FLAGS



## Teardrop



- Single or double-sided
- Available as 9ft (Fabric size: 26"x79"), 12ft (Fabric size: 28"x118"), and 15ft (Fabric size: 32"x149")
- Complete unit includes printed fabric, pole, and support base

### Fabric Options:

- Single-sided: 110g knitted polyester (80% reverse bleed), *Swatch Booklet pg 29*
- Double-sided: 100D Polyester, *Swatch Booklet pg 30*
- *Duplex printing options apply, see previous page*



## Rectangular



- Single or double-sided
- Available as 7ft (Fabric size: 28"x65"), 10ft (Fabric size: 28"x102"), and 13ft (Fabric size: 28"x129")
- Complete unit includes printed fabric, pole, and support base

### Fabric Options:

- Single-sided: 110g knitted polyester (80% reverse bleed), *Swatch Booklet pg 29*
- Double-sided: 100D Polyester, *Swatch Booklet pg 30*
- *Duplex printing options apply, see previous page*

## Accessories



Ground Stake



Premium Cross Base



Hollow Cross Base



Water Weight Bag



Auger Sleeve



Fix Mounted 90° Base

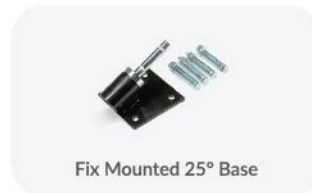

Fix Mounted 25° Base



Tent Post Bracket



Car Tire Base

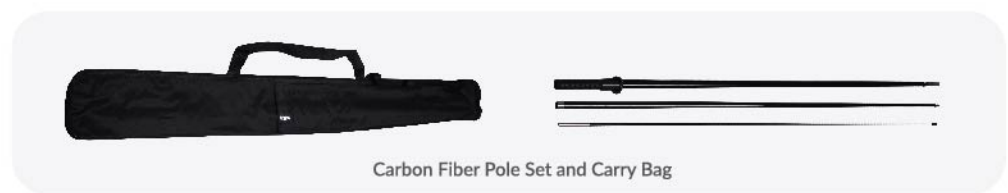

Carbon Fiber Pole Set and Carry Bag

# Specialty Shape Flags



## Magnum Flag

- Single-sided full color dye sublimation printing
- 115g Knitted Polyester (*Swatch Booklet* pg 31)
- Complete unit includes fabric, pole, and base
- 7ft tall with fabric size of 26"x48"



## Leaf Flag



- Single-sided full color dye sublimation printing
- 115g Knitted Polyester (*Swatch Booklet* pg 31)
- Complete unit includes fabric, pole, and base
- 10ft tall with fabric size of 35"x102"



## Lantern Flag

- Single-sided full color dye sublimation printing
- 115g Knitted Polyester (*Swatch Booklet* pg 31)
- Complete unit includes fabric, pole, and base
- 9ft tall with fabric size of 43"x67"



## R Flag



- Single-sided full color dye sublimation printing
- 115g Knitted Polyester (*Swatch Booklet* pg 31)
- Complete unit includes fabric, pole, and base
- 7ft tall (fabric size: 35"x48"), 9ft tall (fabric size: 38"x64"), 11ft tall (fabric size: 49"x77")



# CUSTOM BANNERS



## Single- and Double-Sided Custom Sized Banners

- Custom and standard sizes available
- Single- or double-sided options
- Numerous fabric choices based on intended use
- Full-color printing with PMS match
- Double-edge stitching throughout, hemmed, grommets, or pole pockets included



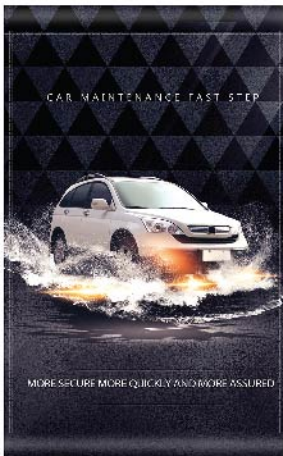

Pole Pockets

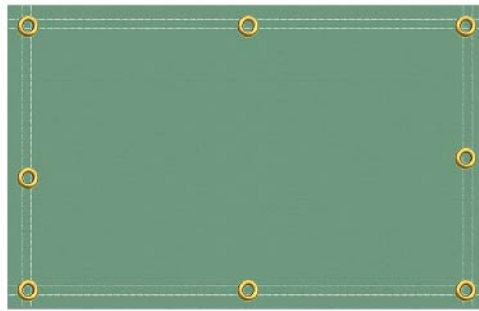

Grommets

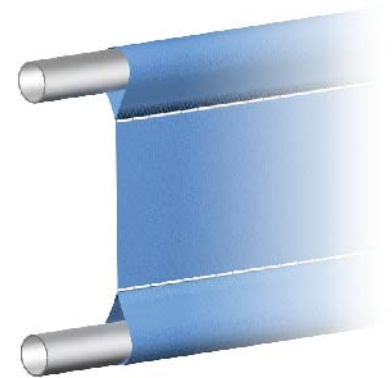

Pole Pocket Detail

### Fabric Options:

- 600D Polyurethane Coated Polyester (outdoor use): *Swatch Booklet pg 1*
- 9oz Flame-retardant Soft Knit (indoor use): *Swatch Booklet pg 9*
- 8oz Blockout Fabric (indoor use): *Swatch Booklet pg 13*
- 600D Tarpaulin (indoor/outdoor use): *Swatch Booklet pg 17*
- 115g Knitted Polyester (indoor/outdoor use): *Swatch Booklet pg 31*
- 120g Mesh Polyester (outdoor use for fence banners): *Swatch Booklet pg 33*
- Duplex\* Printed Blockout Polyester (indoor use): *Swatch Booklet pg 24*
- Duplex\* Printed 115g Knitted Polyester (indoor use): *Swatch Booklet pg 25*
- Duplex\* Printed 100D Polyester (indoor use): *Swatch Booklet pg 26*
- Duplex\* Printed Satin (indoor use): *Swatch Booklet pg 27*

\*Additional costs apply

### Single-Sided Banner



### Double-Sided Banner



### Fence Banners

Fence Banners are designed for outdoor use. The mesh polyester fabric allows for wind to pass through, increasing durability. Widths up to 10ft without a seam.

- Custom and standard sizes available
- Single-sided only
- Full-color printing with PMS match
- Double-edge stitching throughout, hemmed, and grommets included

#### Fabric Options:

- 120g Mesh Polyester (outdoor use for fence banners): *Swatch Booklet pg 33*

# CUSTOM BANNERS

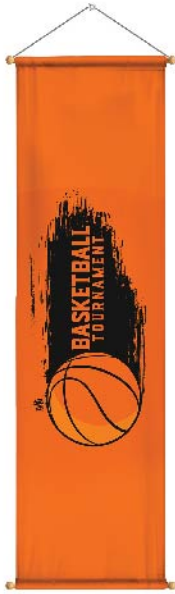

## Hanging Banners

This hanging banner can be used indoors and outdoors. It includes a double sided Duplex print on a single-ply blockout fabric.

- Custom sizes available (max width is 45")
- 2-sided full color digital print
- Includes wooden poles top & bottom w/ hanging string

### Fabric Options:

- Duplex Printable Blockout Polyester, *Swatch Booklet pg 24*



Straight w/ Fringe

Straight



## Podium Banners

Available as a straight cut, angle cut, or V cut, with or without tassels and/or fringe. Custom sizes, shapes, and hardware are also available.

- Full color dye sublimation printing with PMS color matching
- The complete set includes a dowel rod, hanging string, tassels and/or fringe
- Standard sizes include 22"x30", 26"x48", 30"x54", and 42"x60"

### Fabric Options:

- 9oz Flame-retardant Soft Knit, *Swatch Booklet pg 9*



Angled

V-Cut

## Street Pole Banners

These double-sided street pole banners are made with a high-quality, durable, polyester fabric that is ideal for all weather conditions.

- Full color dye sublimation printing with PMS color matching
- Double-sided banner with block-out inner liner
- Pricing based on fabric only (need existing hardware) or complete unit including support hardware
- Standard sizes: 18"x36", 24"x54", 30"x60", 30"x72", 30"x96"

### Fabric Options:

- 600D Polyurethane Coated Polyester, *Swatch Booklet pg 1*





# CUSTOM FLAGS



## Flag Pole Flags

These high-quality flags are digitally printed on premium polyester in full color using UV-treated inks. Flags are finished with a canvas header, brass grommets or pole pockets, and double-edge stitching on all sides.

- Full color digital printing with PMS color matching
- The single-sided flag reads correctly on one side with a 95% reverse bleed
- The double-sided reads correctly on both sides and includes a block-out liner
- Duplex printing also available at an additional cost (single-ply with 2 sided print)
- Custom sizes and shapes available
- Made with highly-durable polyester fabric
- Horizontal and vertical flags available
- Canvas header (black or white), brass grommets or pole pockets, and reinforced double-edge stitching
- Standard sizes include 2x3ft, 3x5ft, 4x6ft, 5x8ft, 6x10ft, and 8x12ft



### Fabric Options:

- 110g Knitted Polyester, *Swatch Booklet pg 29*
- 100D Polyester, *Swatch Booklet pg 30*
- Duplex Printed 100D Polyester, *Swatch Booklet pg 26*
- Duplex Printable Blockout Polyester, *Swatch Booklet pg 24*





## Triangle Pennant Flags

These triangle pennant flags are most commonly used for boating activities and events.

- Full color digital printing with PMS color matching
- Single- and double-sided print options
- Duplex printing also available at an additional cost (single-ply with 2 sided print)
- Custom sizes available upon request
- Canvas header (black or white), brass grommets or pole pockets, and reinforced double-edge stitching
- Standard sizes include 12"x18", 16"x24", 2x3ft, 2.5x4ft, 3x5ft, 4x6ft, and 5x8ft

### Fabric Options:

- 110g Knitted Polyester, *Swatch Booklet pg 29*
- Duplex Printed 115g Knitted Polyester, *Swatch Booklet pg 25*



## Pennant Strings/Bunting

Our pennant strings/bunting are available in two size options as either square or rectangular shapes, single- or double-sided on various canvas string lengths.

- Full color digital printing with PMS color matching
- Single- and double-sided print options
- Available as a 9"x12" and 12"x18" rectangle or triangle shape
- Available lengths: 15ft (10 flags), 30ft (20 flags), 60ft (40 flags), and 100ft (67 flags)

### Fabric Options:

- 100D Polyester, *Swatch Booklet pg 30*





## Backpack Flags

Backpack flags are an ideal mobile product to complement any marketing campaign. The flags are worn as a backpack, allowing for constant mobility and customer engagement.

- Full color digital printing with PMS color matching
- The complete set includes a printed flag, carbon fiber pole, and component storage space
- Available as single- and double-sided print
- Shapes include Blade or Teardrop
- Standard sizes include 21"x41" (Teardrop) and 21"x49" (Blade)

### Fabric Options:

- 110g Knitted Polyester, *Swatch Booklet pg 29*



Our premium, custom-printed golf flags will proudly display your brand or message at any golfing event.

- Full color digital printing with PMS color matching
- Standard fixing option includes a pole pocket with plastic sleeve or canvas header and grommets
- Available as single- and double-sided print
- Duplex printing also available at an additional cost (single-ply with 2 sided print)
- Standard size is 14x20"

### Fabric Options:

- 210D Oxford, *Swatch Booklet pg 32*
- Duplex Printed 210D Oxford, *Swatch Booklet pg 28*

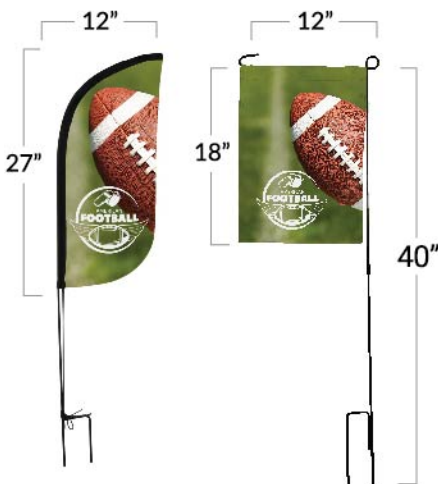

## Garden Flags

These flags are easy to set up and provide maximum brand exposure.

- Full color digital printing with PMS color matching
- The complete set includes a printed flag and support poles
- Available as single- and double-sided print
- Shapes include Rectangle or Convex
- Standard fabric sizes include 12"x18" (Rectangle) and 12"x27" (Convex)
- Applicable support poles are 40" high

### Fabric Options:

- 110g Knitted Polyester, *Swatch Booklet pg 29*

# CUSTOM FLAGS

## Tabletop Feather Flags



These table top displays are easy to set up, lightweight, portable, and ideal for utilizing valuable table space to communicate your message.

- Full color digital printing with PMS color matching
- The complete set includes a printed flag, support poles, and base
- Available as single- and double-sided print
- Shapes include Blade or Teardrop
- Standard fabric size includes 6"x14" (Teardrop) and 6"x16" (Blade)
- Total assembled height: 16" for Teardrop and 17" for Blade

### Fabric Options:

- 110g Knitted Polyester, *Swatch Booklet pg 29*
- 100D Polyester, *Swatch Booklet pg 30*

## Mini Flags



These mini flags secure to any surface using a suction cup or clip base. Lightweight and easy to set up, mini flags are ideal for trade shows, retail environments and offices.

- Full color digital printing with PMS color matching
- The complete set includes a printed flag, support poles, and clip or suction cup base
- Available as single- and double-sided print
- Shapes include Blade, Rectangle, and Teardrop
- Standard fabric size includes 12"x24" (Teardrop), 12"x27" (Blade), and 18"x32" (Rectangle)
- Total assembled height: 30" (Teardrop), 34" (Blade), 32" (Rectangle)

### Fabric Options:

- 110g Knitted Polyester, *Swatch Booklet pg 29*
- 100D Polyester, *Swatch Booklet pg 30*

## Felt Pennants



Felt pennants are the ideal product to proudly display your college sports team.

- Full color dye sublimation printing with PMS color matching
- Available with two different finishes (A: with tie strings or B: header with pocket)
- Available as single-sided only
- Standard size is 12"x18" with custom sizing available

### Fabric Options:

- 10oz Felt, *Swatch Booklet pg 23*





## Desktop Flags



These custom flags are ideal for displaying your brand or message in an office or conference room environment.

- Full color digital printing with PMS color matching
- The complete set includes a printed flag, support pole, and round base
- Available as single- or double-sided flag and print
- Standard fabric sizes include 5.5"x8.3"

### Fabric Options:

- 110g Knitted Polyester, *Swatch Booklet pg 29*
- Duplex Printed 115g Knitted Polyester, *Swatch Booklet pg 25*

## Handheld Flags



Ideal for crowded events, these flags are a cost-effective way of displaying a logo and brand.

- Full color digital printing with PMS color matching
- The complete set includes a printed flag and pole
- Available as single- or double-sided flag and print
- Standard sizes include 4"x6", 6"x9", 8"x12", 16"x24", 12"x18", and 24"x36"

### Fabric Options:

- 110g Knitted Polyester, *Swatch Booklet pg 29*

## Breakaway Flag



Create additional excitement for any sporting event with this unique product.

- Full color dye sublimation printing with PMS color matching
- Set includes two fabric pieces with velcro for connection (poles not included)
- Available as single-sided only
- Standard sizes include 6x10ft, 6x12ft, 8x10ft, and 8x12ft

### Fabric Options:

- 600D Polyurethane Coated Polyester, *Swatch Booklet pg 1*

## Body Flags



This unique product is worn by an individual and is great for any type of event.

- Full color digital printing with PMS color matching
- Single-sided print with two sleeves to insert arms
- Standard sizes include 2x3ft and 3x5ft

### Fabric Options:

- 110g Knitted Polyester, *Swatch Booklet pg 29*

## Custom Fabric Covers



### Spare Tire/Tire-Stack Cover

- Single-sided full color dye sublimation printing
- 600D Polyurethane Coated Polyester (*Swatch Booklet* pg 1)
- Spare tire cover: 26", 28", 32", 35" diameter
- Tire stack cover: custom sizing applies, inquire for details



### Bollard Cover



- Single-sided full color dye sublimation printing
- 7oz Flame-Retardant Stretch Polyester (*Swatch Booklet* pg 6)
- Standard size is 14.5" Dia x 36"
- Custom sizing available, inquire for details



### Trashcan Cover

- Single-sided full color dye sublimation printing
- 7oz Stain-resistant Stretch Polyester (*Swatch Booklet* pg 7)
- Standard sizes include 10, 20, 32, 44, and 55 Gallon



### Security Pedestal Cover



- Full color full color dye sublimation printing
- 7oz Stretch Polyester (*Swatch Booklet* pg 5)
- Standard sizes include 16"x56", 25"x54", and 27"x58"
- Custom sizes available upon request



# CUSTOM FLAGS



## Barrier Cover

- Double-sided print (front and back)
- 600D Polyurethane Coated Polyester (*Swatch Booklet* pg 1)
- Standard sizes: 3.5x6ft (35"x72") and 3.5x8ft (35"x96")
- Custom sizing available upon request



## Chair Back Cover



- Single-sided full color dye sublimation printing (front and back)
- 7oz Stretch Polyester (*Swatch Booklet* pg 5)
- Standard size is 16"x8"
- Custom sizes available upon request



## Chair Band Cover

- Full color dye sublimation printing (front and back)
- Single-layer (print on outside, white on the inside) or double-layer (2 pieces of fabric sewn together w/ print on inside and outside)
- 7oz Stretch Polyester (*Swatch Booklet* pg 5)
- Standard size is 16"x8"
- Custom sizes available upon request



## Chair Cover



- Single-sided full color dye sublimation printing
- Stretch or pleated leg options available
- 8oz Flame-Retardant Stretch Polyester (*Swatch Booklet* pg 8)
- Standard size is 15"x32"
- Custom sizes available upon request





# CAR PRODUCTS



## Car Cover



- Full color digital printing with PMS color matching
- Standard fabric size includes 168"x290" (Standard) or 192"x310" (Large)
- Double-edge stitching with or without elasticized edge
- Custom sizes and fitted stretch polyester covers available upon request

### Fabric Options:

- 100D Polyester (default), *Swatch Booklet pg 30*
- 7oz Stretch Polyester, *Swatch Booklet pg 5*

## Car Hood Cover



- Full color dye sublimation printing with PMS color matching
- Fabric sizes include 32"x54", 39"x57", or 47"x61"
- Double-edge stitching with elasticized edge

### Fabric Options:

- 7oz Stretch Polyester, *Swatch Booklet pg 5*

## Car Headrest Cover



- Full color dye sublimation printing with PMS color matching
- Sold as a set of 2 pieces
- Standard fabric size is 9"x10"
- Double-edge stitching with elasticized edge

### Fabric Options:

- 7oz Stretch Polyester, *Swatch Booklet pg 5*

# CAR PRODUCTS



## Car Window Flag

- Full color digital printing with PMS color matching
- Standard fabric size is 18"x12" with a 20" pole
- Single- or double-sided options
- Complete unit includes fabric and support pole

### Fabric Options:

- 110g Knitted Polyester, *Swatch Booklet pg 29*



## Magnetic Car Flag

- Full color digital printing with PMS color matching
- Standard fabric size is 8.25"x5.5" with 12" plastic pole
- Single- or double-sided options
- Complete unit includes fabric, support pole, and magnetic base

### Fabric Options:

- 110g Knitted Polyester, *Swatch Booklet pg 29*



## Stationary Car Window Flag

These flags connect to the car window and are designed for stationary use only.

- Full color digital printing with PMS color matching
- Single- or double-sided options
- Complete unit includes fabric support pole and window clip
- Available in 3 different shapes:
  - 36" Blade flag with 9.5"x26" print size
  - 33" Teardrop flag with 11"x24" print size
  - 32" Rectangle flag with 11"x22" print size

### Fabric Options:

- 110g Knitted Polyester, *Swatch Booklet pg 29*



# CUSTOM DISPLAYS





## Modular Fabric Displays

Communicate any message to your audience with our versatile modular frame displays. Available in various sizes and shapes, lightweight aluminum tubing connects to form the frame with custom-printed fabric that simply slides on the frame like a pillow case. Easy to set up and break down, with all components fitting into one carry bag. Buy a complete unit with a frame and graphic and simply order a new graphic when needed.

- Full color dye sublimation printing with PMS color matching
- Available as Straight, C-Shaped, and Curved shaped
- Single- and double-sided print options available
- Complete set includes the aluminum tubing frame, printed fabric and carry bag
- Easy to assemble and lightweight

### Fabric Options:

- 8oz Tension Fabric, *Swatch Booklet pg 11*



Carry Bag



Easy Assembly

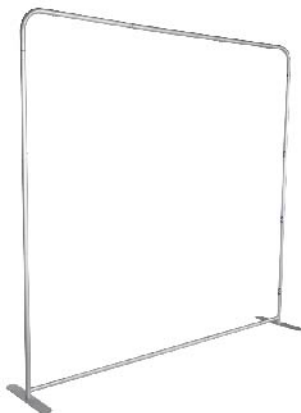

## Straight Fabric Display Walls

- Full color dye sublimation printing with PMS color matching
- The complete set includes printed fabric, support frame, and carry bag
- Single- and double-sided print options available
- Standard sizes include: 8ft (96"x89"), 10ft (114"x89"), 20ft (234"x89")

### Fabric Options:

- 8oz Tension Fabric, *Swatch Booklet pg 11*



# CUSTOM DISPLAYS

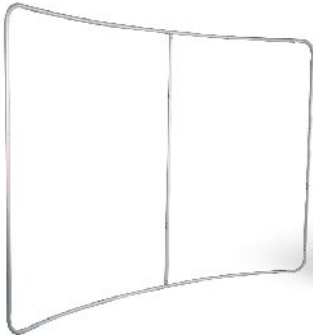

## C-Shaped Fabric Display Wall

- Full color dye sublimation printing with PMS color matching
- The complete set includes printed fabric, support frame, and carry bag
- Single- and double-sided print options available
- Standard sizes include: 8ft (96"x89") and 10ft (118"x89")

### Fabric Options:

- 8oz Tension Fabric, Swatch Booklet pg 11

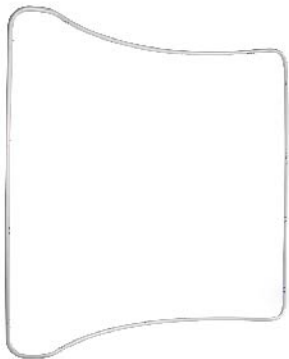

## Curved Fabric Display Wall

- Full color dye sublimation printing with PMS color matching
- The complete set includes printed fabric, support frame, and carry bag
- Single- and double-sided print options available
- Standard sizes include: 8ft (100"x89") and 10ft (118"x89")

### Fabric Options:

- 8oz Tension Fabric, Swatch Booklet pg 11





## Straight Fabric Display Stands

- Full color dye sublimation printing with PMS color matching
- The complete set includes printed fabric, support frame, and carry bag
- Single- and double-sided print options available
- Standard sizes include: 2ft (24"x89"), 3ft (36"x89"), 4ft (48"x89"), 5ft (60"x89")
- *Custom sizes are available with no minimums, inquire for details*

### Fabric Options:

- 8oz Tension Fabric, Swatch Booklet pg 11



## Adjustable Banner Walls

This adjustable banner wall accommodates various heights and widths. This product includes a telescopic frame and fabric print that attaches with pole pockets. Buy a complete unit with a frame and graphic and simply order a new graphic when needed.

- Full color dye sublimation printing with PMS color matching
- Available as single- or double-sided print
- Complete unit includes a silver aluminum frame, fabric, and carry bag
- Accommodates any fabric sizes between 43" and 118" wide and 52" and 90" high

### Fabric Options:

- 9oz Flame-Retardant Soft Knit, Swatch Booklet pg 9





# CUSTOM DISPLAYS

## X/L Banner Displays

These lightweight and economical banner displays provide a simple marketing solution for any trade show or event. These banners set up quickly and do not require any tools. Buy a complete unit with the frame and graphic and simply order a new graphic when needed.

- Full color digital printing with PMS color matching
- The complete set includes printed fabric and support frame
- Available as single-sided only
- X-Banner standard sizes include: 24"x63", 32"x70", and 48"x83"
- L-Banner standard sizes include: 32"x79", 118"x90", and 236"x90"

### Fabric Options:

- 600D Tarpaulin, *Swatch Booklet pg 17*
- 8oz Tension Fabric, *Swatch Booklet pg 11*



L-Banner

X-Banner

L-Banner

## Retractable Banners

### STANDARD & PREMIUM BASE OPTIONS

The Standard version is a lower cost alternative that includes swivel support feet, while the Premium retractable banners have a sleek and polished appearance. All base options include a 600D polyester substrate for increased durability.

- Full color dye sublimation print with PMS color matching
- The complete set includes printed fabric, support pole, base, and carry bag
- Available as single- and double-sided
- Standard and Premium sizes are 34"x79"

### Fabric Options:

- 600D Tarpaulin, *Swatch Booklet pg 17*



Standard Retractable Base



Premium Retractable Base



Double Sided



Double Sided

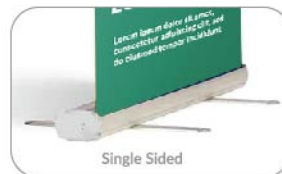

Single Sided



Single Sided

Standard Retractable Base

Premium Retractable Base



## Heart Shaped Backdrop

This extraordinary display will attract extra attention during any special event.

- Full color dye sublimation printing with PMS color matching
- The complete set includes printed fabric, support frame, and carry bag
- Single- and double-sided print options available
- Standard size is 79"x77"

### Fabric Options:

- 8oz Tension Fabric, Swatch Booklet pg 11



## Round Shaped Backdrop

This circular display provides a large and unique surface area to communicate any message or graphic.

- Full color dye sublimation printing with PMS color matching
- The complete set includes printed fabric, support frame, and carry bag
- Single- and double-sided print options available
- Standard sizes are 5ft (Diameter: 59", Height: 87") and 6.5ft (Diameter: 79", Height: 87")

### Fabric Options:

- 8oz Tension Fabric, Swatch Booklet pg 11



## Arched Shaped Display Kit

SOLD AS A KIT OF 3 PIECES

Draw attention to your message by utilizing this contemporary backdrop.

- Full color dye sublimation printing with PMS color matching
- The complete set includes printed fabric, support frame, and carry bag
- Single- and double-sided print options available
- Kit A: Section 1 & 3 (36"x72"), Section 2 (48"x84")
- Kit B: Section 1 (36"x72"), Section 2 (48"x84"), Section 3 (36"x48")

### Fabric Options:

- 8oz Tension Fabric, Swatch Booklet pg 11



# CUSTOM DISPLAYS

## Display Podiums

Our variety of custom-printed display podiums combines a table surface with custom-printed fabric, pairing well with display walls to complete any trade show booth. Available in various shapes and heights, these podiums are easy to set up and include a plastic base and top.

- Full color dye sublimation printing with PMS color matching on all sides of podium
- Includes spring-up and fixed display (aluminum tubing posts) options where applicable
- Complete set includes printed fabric, plastic top and bottom, support frame, and carry bag

### Fabric Options:

- 8oz Tension Fabric, *Swatch Booklet pg 11*



### Oval Pop-Up Display Podium

Oval podium with levered spring system for instant setup and takedown includes a heavy duty plastic top and bottom, metal cross brace, hydraulic springs, and carry bag.

- Full color dye sublimation printing with PMS color matching
- Standard size is 27" (width) X 16" (diameter) X 40" (height)

### Fabric Options:

- 8oz Tension Fabric, *Swatch Booklet pg 11*



### Oval Pop-Up Display Podium w/ LED Lights

This pop-up podium adds an LED component to really attract attention to your display.

- Full color dye sublimation printing with PMS color matching
- Standard size is 27" (width) X 16" (diameter) X 40" (height)
- Includes LED lights secured to the base

### Fabric Options:

- 8oz Tension Fabric, *Swatch Booklet pg 11*



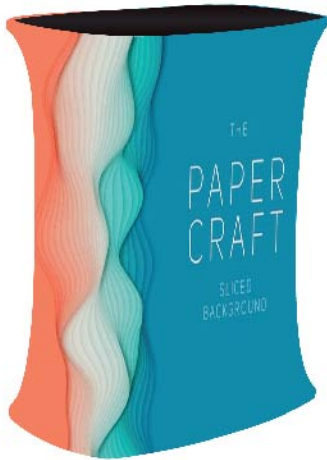

## Rectangle Pop-Up Podium

This podium includes a fixed frame with aluminum tubing posts that connect the counter top and base.

- Full color dye sublimation printing with PMS color matching
- The complete set includes printed fabric, support posts, top, base, and carry bag
- Standard size is 32" (L) x 20" (W) x 39" (H)

### Fabric Options:

- 8oz Tension Fabric, Swatch Booklet pg 11

## Folding Display Counter

This folding counter separates into 2 pieces for a simple breakdown, allowing support poles to be stored.

- Full color dye sublimation printing with PMS color matching
- The complete set includes printed fabric, support posts, top, base, and carry bag
- Standard size is 76" (L) x 23" (W) x 37" (H)

### Fabric Options:

- 8oz Tension Fabric, Swatch Booklet pg 11



## Rectangular Counter

This counter includes a collapsible frame that connects to the counter top and base.

- Full color dye sublimation printing with PMS color matching
- The complete set includes printed fabric, support posts, top, base, and carry bag
- Standard size is 32" (L) x 20" (W) x 39" (H)

### Fabric Options:

- 8oz Tension Fabric, Swatch Booklet pg 11

## Display Podium Kit

SOLD AS A KIT OF 3 PIECES

This podium kit includes three round fixed frame podiums with aluminum tubing posts that connect the counter top and base.

- Full color dye sublimation printing with PMS color matching
- The complete set includes printed fabric, support posts, top, base, and carry bag
- Sizing: Section 1 (13" Dia x 24"), Section 2 (14" Dia x 30"), Section 3 (16" Dia x 35")

### Fabric Options:

- 8oz Tension Fabric, Swatch Booklet pg 11



# CUSTOM DISPLAYS

## Expandable Banner Walls

This lightweight and versatile wall display is an alternative to the modular banner wall. Available as a straight or curved option, set up and break down are simple, and all components fit into one carry bag. Buy a complete unit with a frame and graphic and simply order a new graphic when needed.

### Straight Expandable Walls



3 Foot



5 Foot

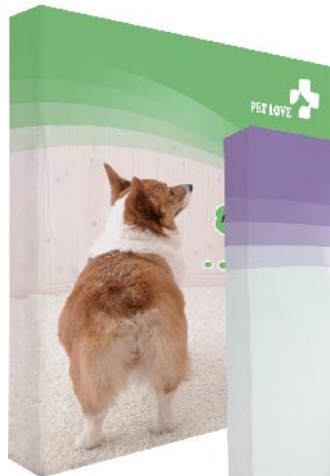

8 Foot



10 Foot

- Full color dye sublimation printing with PMS color match
- Complete unit includes an expandable aluminum frame, printed fabric, and carry bag
- Standard sizes:
  - 3ft: 29"x89" Frame Size. Total printed fabric size is 57"x89"
  - 5ft: 57"x89" Frame Size. Total printed fabric size is 86"x89"
  - 8ft: 87"x89" Frame Size. Total printed fabric size is 116"x89"
  - 10ft: 115"x89" Frame Size. Total printed fabric size is 143"x89"



### Fabric Options:

- 8oz Tension Fabric, *Swatch Booklet pg 11*
- 9oz Flame-Retardant Soft Knit, *Swatch Booklet pg 9*

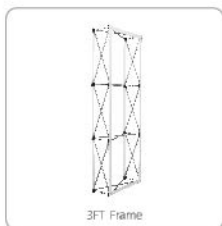

3FT Frame

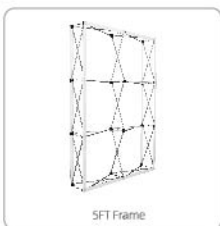

5FT Frame

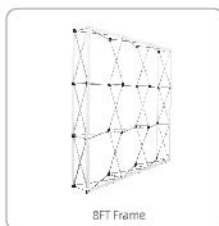

8FT Frame



10FT Frame



## Curved Expandable Walls

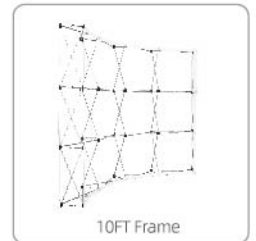
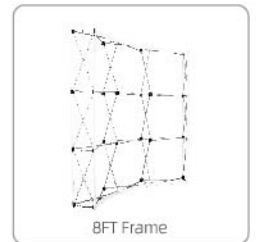

- Full color dye sublimation printing with PMS color match
- Complete unit includes an expandable aluminum frame, printed fabric, and carry bag
- Standard sizes:
  - 8ft: 81"x89" Frame Size. Total printed fabric size is 109"x89"
  - 10ft: 108"x89" Frame Size. Total printed fabric size is 137"x89"

### Fabric Options:

- 8oz Tension Fabric, *Swatch Booklet pg 11*
- 9oz Flame-Retardant Soft Knit, *Swatch Booklet pg 9*

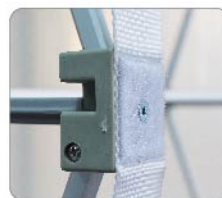



# CUSTOM DISPLAYS

## Floor Grid Displays

This dynamic and expandable banner wall system allows for the construction of various sizes and shapes based on connecting 28"x28" square sections together. The fabric is then connected to the frame as either one continuous piece or as individual square sections. Multiple layers of fabric can be applied to various sections.

- Full color dye sublimation printing with PMS color match
- Complete unit includes an expandable aluminum frame, printed fabric, and carry bag
- Standard sizes: 1x3 (28"x84"), 2x3 (56"x84"), 2x2 (56"x56"), 3x3 (84"x84"), and 6 Quad Pyramid (126"x81")

### Fabric Options:

- 8oz Flame-retardant Stretch Polyester, *Swatch Booklet pg 8*



3x3



2x2



2x3



6 Quad Pyramid



1x3

## Table Top Displays

Table top displays are perfect for utilizing valuable table space to communicate your message.

### Overhead Displays

These displays complement any table cover presentation by proudly exhibiting your message without using additional floor space. The support frame brackets connect to the sides of the table, while the printed fabric fits over the frame like a pillow cover. This product is lightweight and easy to set up.

- Full color dye sublimation printing with PMS color match
- Complete unit includes printed fabric, aluminum tube support frame, brackets, and carry bag
- Single-sided (printed on front only, back remains white) and double-sided (printed front and back) available
- Standard sizes:
  - 6ft table (3 fabric size options) : 16"x72", 40"x72" and 63"x72"
  - 8ft table (3 fabric size options) : 16"x96", 40"x96" and 63"x96"

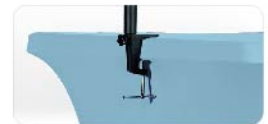

Side Bracket

#### Fabric Options:

- 7oz Stretch Polyester, *Swatch Booklet pg 5*



16" High Fabric



40" High Fabric

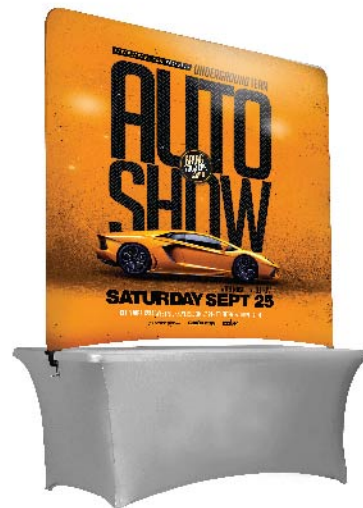

63" High Fabric



### Table Top Side Panels

Used as an alternative to the Overhead Display should one prefer to maximize viewing space.

- Full color dye sublimation printing with PMS color matching
- Available as single- and double-sided
- Standard size is 16"x57" per panel

#### Fabric Options:

- 7oz Stretch Polyester, *Swatch Booklet pg 5*



# CUSTOM DISPLAYS



## Table Top Expandable

This expandable banner is an effective table top backdrop solution.

- Full color dye sublimation printing with PMS color match
- Complete unit includes an expandable aluminum frame, printed fabric, and carry bag
- Standard size is 60"x12"x60"

### Fabric Options:

- 8oz Tension Fabric, *Swatch Booklet pg 11*
- 9oz Flame-Retardant Soft Knit, *Swatch Booklet pg 9*



## Monopad Flag Display

This unique banner provides a compact and easy-to-read surface for any graphic.

- Full color dye sublimation printing with PMS color matching
- The complete set includes printed fabric, support frame, base, and carry bag
- Single- and double-sided print options available
- Standard sizes are Small (Fabric: 11"x20", Frame: 12"x31") and Large (Fabric: 11"x39", Frame: 12"x51")

### Fabric Options:

- Duplex Printable Blockout Polyester, *Swatch Booklet pg 11*



## Table Top Tension Fabric Display

This is a table top version of the Curved Fabric Display Wall.

- Full color dye sublimation printing with PMS color matching
- The complete set includes aluminum tubing frame and carry bag
- Single- and double-sided print options available
- Standard sizes is 32"x20"

### Fabric Options:

- 8oz Tension Fabric, *Swatch Booklet pg 11*



# Table Top Grid Banners

These are exactly the same as the Floor Standing Grid Banners but just on a smaller scale.

- Full color dye sublimation printing with PMS color match
- Complete unit includes an expandable aluminum frame, printed fabric, and carry bag
- Standard sizes: 1x3 (12"x36"), 2x3 (24"x36"), 2x2 (24"x24"), 3x3 (36"x36"), 3 Quad Pyramid (41"x31"), 6 Quad (59"x41"), X Kit (41"x39")

### Fabric Options:

- 8oz Flame-retardant Stretch Polyester, *Swatch Booklet pg 8*



6 Quad Pyramid



2x2



2x3



3x3



1x3

# CUSTOM DISPLAYS

## Barricade Covers

Turn your crowd control barriers into a powerful and effective marketing tool.

### Barrier Frame & Cover

This barrier is sold as a complete unit that includes the support frame and the two sided fabric.

- Full color dye sublimation printing with PMS color match
- Complete unit includes printed fabric, aluminum tube support frame, and carry bag
- Double-sided print (front and back)
- Standard sizes: 3.3ft (35"x40") and 6.3ft (35"x79")

#### Fabric Options:

- 8oz Tension Fabric, *Swatch Booklet pg 11*



## Custom Barrier Jackets

This barrier cover provides a double-sided print with more flexibility on sizing. This cover drapes over the top support and secures to the vertical sides with velcro.

- Full color dye sublimation printing with PMS color match
- Fabric only, no hardware
- Double-sided print (front and back)
- Standard sizes: 6.5ft (33"x72")

#### Fabric Options:

- 600D Tarpaulin, *Swatch Booklet pg 17*



## Custom Barrier Cover Fabric

This barrier cover is designed to fit the standard interlocking metal barriers and bike racks.

- Full color dye sublimation printing with PMS color match
- Fabric only, no hardware
- Double-sided print (front and back)
- Standard sizes: 3.5x6ft (35"x72") and 3.5x8ft (35"x96")
- Custom sizing available upon request

### Fabric Options:

- 600D Polyurethane Coated Polyester, *Swatch Booklet pg 1*



## A-Frame Banner Stand

This A-Frame Banner includes an aluminum frame and two single-sided printed fabric pieces. These are easy to setup and are ideal for any outdoor event.

- Full color dye sublimation printing with PMS color match
- Complete unit includes aluminum support frame, two pieces of printed fabric, and carry bag
- Two pieces of single-sided printed fabric
- Standard frame size: 85"x36" (fabric: 32"x79")



### Fabric Options:

- 600D Polyurethane Coated Polyester, *Swatch Booklet pg 1*





# CUSTOM DISPLAYS

## SEG Light Boxes

This display incorporates silicone edge graphics (SEG) and LED lighting to produce a highly engaging banner wall with illuminated graphics.

- Full color dye sublimation printing with PMS color match
- All versions include a full color printed fabric on the front and back
- Complete unit includes an aluminum frame, printed fabric, and carry bag

### Fabric Options:

- 8oz Tension Fabric, *Swatch Booklet pg 11*



## Standard SEG Light Box

This version has a wide frame with light strips on the top, bottom, and center connector. The display is easy to setup and breakdown with all components fitting into a small carry bag.

- Standard sizes:
  - Height: 6.6ft; Width options: 2.8ft, 3.3ft, 6.6ft, 10ft, 13ft, 16.4ft, 20ft
  - Height: 7.4ft; Width options: 2.8ft, 3.3ft, 6.6ft, 10ft, 13ft, 16.4ft, 20ft
  - Height: 8.2ft; Width options: 2.8ft, 3.3ft, 6.6ft, 10ft, 13ft, 16.4ft, 20ft

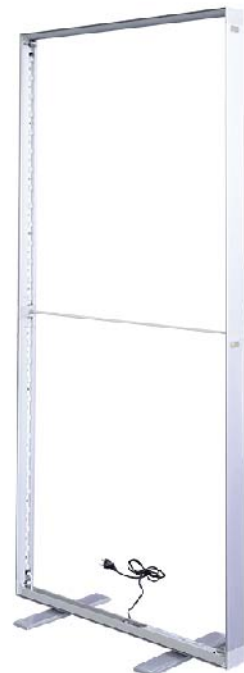
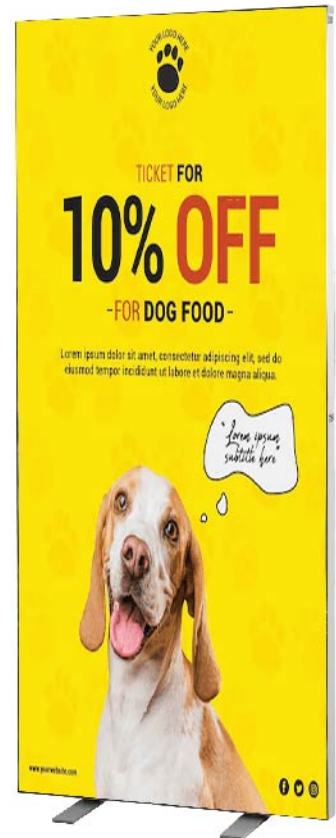

## SEG Light Box Counter

This is the standard version with a composite wood counter top.

- Standard size is 2.8x3.3ft and 3.3x3.3ft



## Folding SEG Light Box

This foldable frame is simple to assemble and includes the light strips on each vertical side. Simply unfold the frame and connect the fabric.

- Standard size is 2.8x6.6ft and 3.3x6.6ft





# CUSTOM DISPLAYS

## Pop-Out Banners

Pop-out banners are a simple and effective marketing product that is portable, lightweight, and easy to assemble. These affordable banners are custom printed to match any brand, increasing awareness at trade shows and all ranges of events.

- Full color dye sublimation printing with PMS color match
- Double-sided print (front and back)
- Complete unit includes wire frame and fabric
- Standard shapes and sizes:
  - **Horizontal:** 28"x48", 40"x79", 44"x102"
  - **Vertical:** 24"x36", 39"x67", 49"x79"
  - **Triangle:** 47"x47", 59"x59"
  - **Round:** 39" Dia, 47" Dia, 56" Dia
  - **Personal Pop-Out** (single-sided):  
48"x28", 79"x39"

### Fabric Options:

- 130g Peach Fabric , *Swatch Booklet pg 11*



Carry Bag



Horizontal



Personal Pop-Out



Round



Vertical



Triangle





## Other Display Products

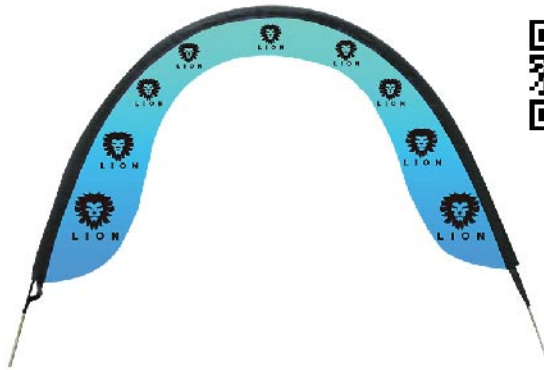

### Racing Air Gate

This arch shaped banner is a great addition to any outdoor event.

- Full color dye sublimation printing with PMS color matching
- The complete set includes printed fabric, support poles, and base
- Standard size include 78"x42", 110"x58", 147"x76"

#### Fabric Options:

- 110g Knitted Polyester, *Swatch Booklet pg 29*

### Custom Floor Mat

Utilize valuable floor space for additional branding with this custom printed carpet.

- Full color dye sublimation printing with PMS color matching
- **Custom sizes are available with no minimums, inquire for details**
- Sizes exceeding 61" will require a seam line
- Standard sizes include 3ftx5ft, 4ftx6ft, 5ftx5ft, 6ftx10ft, 6ftx8ft, 10ftx10ft, 10ftx20ft

#### Fabric Options:

- 110g Knitted Polyester, *Swatch Booklet pg 29*

### Round Hanging Banner

Maximize your brand exposure by taking advantage of the height above your display.

- Full color dye sublimation printing with PMS color matching
- Complete unit includes aluminum tubing frame, hanging wires, printed fabric, and carry bag
- Standard size is 72" Dia x 21" High

#### Fabric Options:

- 8oz Tension Fabric, *Swatch Booklet pg 11*



Underside



Seam Detail



# PROMOTIONAL PRODUCTS



## Pillow Cases

Comfortably brand your decor with this custom printed pillow.

- Full color dye sublimation printing with PMS color matching
- Fabric cover only, pillow not included
- Standard size is 16"x16"

### Fabric Options:

- 7oz Stain-resistant Stretch Polyester, *Swatch Booklet pg 7*



## Arch Display

Primarily used for trade shows, this arch banner will certainly attract attention to your booth.

- Full color dye sublimation printing with PMS color match
- Two sided print (inside and outside)
- Complete unit includes fabric, support frame, two shelves, and carry bag
- Size:
  - Arched Frame: 232" (L) x 40" (W) x 135" (H)
  - Shelf: 38"x11" at height of 38"
  - Graphic: 38"x412"

### Fabric Options:

- 8oz Tension Fabric, *Swatch Booklet pg 11*



## Square Booth Display

A variation of the arch banner, this incorporates a full rear wall to give you a closed environment.

- Full color dye sublimation printing with PMS color match
- Two sided print (inside and outside)
- Complete unit includes fabric, support frame, two shelves, and carry bag
- Size:
  - Square Frame & Graphic: 118" (L) x 40" (W) x 95" (H)
  - Rear Wall (frame & fabric): 118" (L) x 95" (H)
  - Shelf: 38"x11" at height of 38"

### Fabric Options:

- 8oz Tension Fabric, *Swatch Booklet pg 11*



# Promotional Products

DMP offers a variety of fabric based promotional products that compliments our current offering.



## Fabric Sports Bibs

---

- Full color digital print with PMS color matching
- Fabric only with front and rear print
- Standard sizes include 38"x13", 43"x13", 54"x17", 55"x19"

### Fabric Options:

- 115g Knitted Polyester, *Swatch Booklet pg 31*



## Training Bib

---

- Full color digital print with PMS color matching
- Fabric only with front and rear print
- Standard sizes include 17"x20", 18"x21", 19"x22"

### Fabric Options:

- 115g Knitted Polyester, *Swatch Booklet pg 31*



## Gaming Mouse Pad

---

- Full color digital print with PMS color matching
- Multi-spandex top with rubber base (single-sided print)
- Standard sizes include 10"x12", 12"x24", 16"x35"



## Webcam Backdrop

---

- Full color dye sublimation print with PMS color matching
- Single-sided print with wire frame and carry bag
- Standard sizes include 40" Dia and 48" Dia

### Fabric Options:

- 8oz Flame-retardant Stretch Polyester, *Swatch Booklet pg 9*



## Outdoor Promotional Products



### Outdoor Picnic Blanket

- Full color dye sublimation printing with PMS color match
- Single-sided print
- Standard sizes include 79"x79", 96"x79", and 118"x118"

#### Fabric Options:

- Surface: 7oz Wrinkle-resistant 300D Polyester, *Swatch Booklet pg 4*
- Base: High Density 450D Oxford, *Swatch Booklet pg 18*



### Portable Beach Tent

- Full color dye sublimation printing with PMS color match
- Includes printed fabric, internal supports, and carry bag
- Standard size is 52"x52"

#### Fabric Options:

- Water Proof Anti-UV 100g Blockout Fabric



### Portable Sunshade

- Full color dye sublimation printing with PMS color match
- Includes printed fabric, support poles, and carry bag
- Standard sizes include 82"x67", 82"x79" and 118"x118"

#### Fabric Options:

- 7oz Stretch Polyester, *Swatch Booklet pg 5*

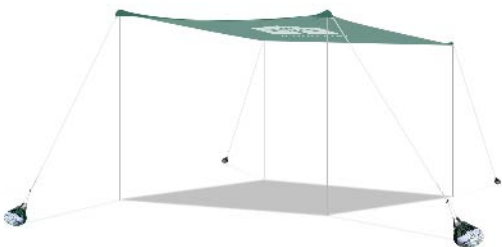

# PROMOTIONAL PRODUCTS

## Safety Vests

DMP offers a variety of safety vests and arm bands using fluorescent fabrics.

- Full color dye sublimation / digital printing
- Full coverage (front and back)
- Dark color prints (black, dark grey) are recommended
- Standard sizes:
  - Reflective X-Vest: 32"x24"
  - Safety Vest w/ Velcro Closure: 22"x27"
  - Safety Vest w/ Zipper Closure: 24"x27"
  - Armband: 4"x14" and 4"x16"



### Fabric Options:

- 300D PU Polyester Fluorescent Orange, *Swatch Booklet pg 21*
- 300D PU Polyester Fluorescent Yellow, *Swatch Booklet pg 22*
- 600D PU Polyester Fluorescent Yellow, *Swatch Booklet pg 20*
- 115g Fluorescent Knitted Polyester Yellow, *Swatch Booklet pg 34*
- 115g Fluorescent Knitted Polyester Orange, *Swatch Booklet pg 35*



Zipper Closure



X-Vest



Arm Band



Velcro Closure



## Umbrellas

DMP offers a variety of patio umbrellas.



- Full color dye sublimation / digital printing
- Complete unit includes frame and canopy (excludes base)
- Standard specifications:
  - 6.5ft Square with or without valance
  - 8ft: 8-rib tilting w/ no valance
  - 10ft: 8-rib with or without valance
  - 10ft Square with or without valance

### Fabric Options:

- 600D Polyurethane Coated Polyester, *Swatch Booklet pg 1*
- 600D PU Polyester Fluorescent Yellow, *Swatch Booklet pg 20*

# DISPLAY KITS

## Basic Canopy Kit



Includes a 6ft table cover and a 10x10 tent w/ canopy.

- SFK10002 Black Steel Frame
- SFK10001 White Steel Frame
- KOI10000 Hex Aluminum Frame



## Basic Table Cover Kit

Includes a 9 or 12ft double-sided feather flag and a 6ft table cover.

- KIN10000 9ft Feather Flag
- KIN10001 12ft Feather Flag



## Standard Canopy Kit



Includes a 12ft double-sided feather flag and a 10x10 tent w/ canopy.

- SFK20002 Black Steel Frame
- SFK20001 White Steel Frame
- KOI20000 Hex Aluminum Frame



## Retractable Banner Kit

Includes a 9 or 12ft double-sided feather flag, a 6ft table cover, and a retractable banner.

- KIN30000 9ft Feather Flag
- KIN30001 12ft Feather Flag



## Deluxe Canopy Kit



Includes two 9ft double-sided feather flags, a 10x10 tent w/ canopy, and a 6ft table cover. Price applies to cross base or tent post base.

- SFK30002 Black Steel Frame
- SFK30001 White Steel Frame
- KOI30000 Hex Aluminum Frame



## Banner Wall Kit

Includes a 9 or 12ft double-sided feather flag, a 6ft table cover, and a 60"x89" banner wall.

- KIN20000 9ft Feather Flag
- KIN20001 12ft Feather Flag



## Premium Canopy Kit



Includes two 12ft double-sided feather flags, a 10x10ft tent w/ canopy single-sided full rear wall + side walls, and a 6ft table cover.

- SFK40002 Black Steel Frame
- SFK40001 White Steel Frame
- KOI40000 Hex Aluminum Frame



## Banner Podium Kit

Includes a 9 or 12ft double-sided feather flag, a pop-up podium, and an 8ft single-sided straight fabric display.

- KIN40000 9ft Feather Flag
- KNI40001 12ft Feather Flag







1739 Sands Place SE, Suite A  
Marietta GA 30067



(888) 600-3070  
sales@discountmp.com



Discover DMP, your trusted source for premium marketing display products. With a focus on customization, affordability, and exceptional quality, we're here to elevate your branding efforts. Partner with us for a seamless and hassle-free experience. Your success is our commitment.

[discountmarketingproducts.com](http://discountmarketingproducts.com)