

# PRODUCT CATALOG

TENTS & SIGNAGE





# TABLE OF CONTENTS

<b>BOOTH PACKAGES</b>	<b>2 – 3</b>
<b>POP-UP TENTS</b>	<b>4 – 13</b>
<b>SPECIALIZED TENTS</b>	<b>14 – 15</b>
<b>INFLATABLES</b>	<b>16 – 27</b>
Inflatable Airdome . . . . .	16
Air Tent . . . . .	20
Airwave . . . . .	21
Air'Lounge . . . . .	22
Air Display Counter . . . . .	24
Air Tower . . . . .	25
Inflatable Arches . . . . .	26
<b>MARQUEE</b>	<b>28 – 29</b>
<b>SKY TENT</b>	<b>30 – 31</b>
<b>TABLE COVERS</b>	<b>32 – 33</b>
<b>FLAGS</b>	<b>34 – 35</b>
<b>UMBRELLAS &amp; BAR</b>	<b>36 – 41</b>
<b>SIGNS &amp; BANNERS</b>	<b>42 – 47</b>
<b>TENSION DISPLAYS</b>	<b>48 – 59</b>
Quick-N-Fit Booth Packages . . . . .	48 - 57
Tension Banners & Walls . . . . .	58 - 59
<b>EVENT FLOORING</b>	<b>60</b>
<b>CHAIRS</b>	<b>61</b>
Custom Printed Sling Chairs . . . . .	61
Branded Folding Chairs . . . . .	62



# DELUXE BUNDLE

Reg. \$1781 **\$1603**

Use Code: **OBUNCA**

**SPECIAL OFFER**



*\*Offer cannot be combined with additional offers*

## DYE SUBLIMATION PRINTING

ITEM #	PRICE	
230324	\$1781	(C)

### PRODUCT SPECIFICATIONS

ITEM	DIMENSIONS	WEIGHT
10' x 10' Tent Top + Frame	116"W x 114"-126"H x 116"D	48 lbs.
10' Wall	116"W x 79"H	4 lbs.
8' Sunblade Flag + Base	26"W x 99"H	3 lbs.
6' Fitted Table Cover	72"W x 29"H x 30"D	3 lbs.

*\*Table Not Included*

### Includes:

- (1) 10' x 10' Fully Printed Tent Top**
- (1) 10' x 10' V5 Tent Frame**
- (1) Single-Side Printed 10' Wall**
- (1) Single-Side Printed 8' Sunblade Flag + X-base**
- (1) Front Panel Only Printed 6' Fitted Table Cover**
- Free Stake Kit & Dust Cover**



# TRADESHOW STARTER KIT

Reg. \$875 **\$787**

Use Code: TSKITCA

**SPECIAL OFFER**



*\*Offer cannot be combined with additional offers*

BOOTH PACKAGES

## DYE SUBLIMATION PRINTING

ITEM #	PRICE	
230325	\$875	(C)

### PRODUCT SPECIFICATIONS

ITEM	DIMENSIONS	WEIGHT
Backdrop	120"W × 96"H	9 lbs.
Retractable Banner	33.5"W × 80"H	9 lbs.
6' Non-Fitted Table Cover	72"W × 29"H × 30"D	3 lbs.



*\*Table & Backdrop Frame Not Included*

### Includes:

- (1) Single-Side Printed 10' × 8' Backdrop**
- (1) Single-Side Printed Retractable Banner**
- (1) Fully Printed 6' Non-Fitted Table Cover**

**CUSTOM POP-UP TENTS**



	<b>GOOD</b>	<b>BETTER</b>	<b>BEST</b>
	Pg. 6	Pg. 7	Pg. 8
<b>Frame Material</b>	Powder Coated Steel	Powder Coated Steel	Anodized Aluminum
<b>Frame Thickness</b>	.08 mm	1.2 mm	1.2 mm
<b>Leg Shape</b>	Square	Hexagonal	Hexagonal
<b>Leg Diameter</b>	30 mm (1.25")	45 mm (1.75")	45 mm (1.75")
			
<b>Weight</b>	48 lbs – 10'x10'	52 lbs – 10'x10'	32 lbs – 10'x10'
<b>Durability</b>	5/10	7/10	6/10
<b>Warranty</b>	1 year	2 years	2 years
<b>Sizes</b>	5'x5', 10'x10', 10'x15', 10'x20'	10'x10', 10'x15', 10'x20'	10'x10', 10'x15', 10'x20'
			50 lbs – 10'x10'
			10/10
			Lifetime
			10'x10', 10'x15', 10'x20'

**V3: POP-UP LINE BEST SELLER**

The V3 is our star pop-up canopy due to its superb strength and durability. With 20 years of experience in optimization, we designed this super-duty tent that is ideal for intense and long term use. Created for life in the field, the V3 will always create an impactful presentation of any brand at all events & trade shows.



## PRINTING OPTIONS

### FULL DYE-SUB PRINTED TOP

(4) Printed Peaks + (4) Printed Valances



### FULL DYE-SUB PRINTED FRONT

(1) Printed Peak + (1) Printed Valance +  
(3) Stock Peaks + (3) Stock Valances



### STOCK COLOR TOP

(4) Stock Peaks + (4) Stock Valances

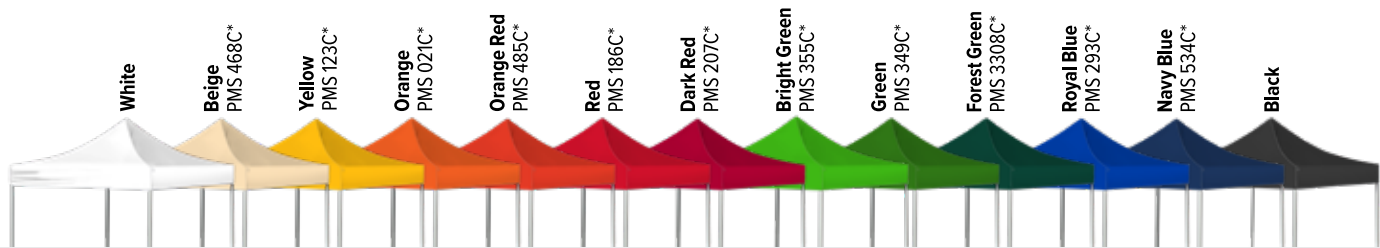

### STOCK COLORS

\*PMS colors are for reference only and may vary slightly from actual color.





▶ POP-UP TENTS



# A RELIABLE AND COST-EFFECTIVE CUSTOM PRINTED POP-UP TENT



**A. Square STEEL LEGS** are finished with powder coating to protect against rust and provide longer lifetime durability.

**B. ABS FITTINGS** for longer durability and support to the frame

**C. THUMB LATCH** for faster, easier height adjustment



- ✓ An affordable, commercial steel frame that is ideal for any budget.
- ✓ A strong and dependable promotional pop-up tent.



**5' x 5' TENT TOP (600 DENIER POLYESTER) + FRAME**

ITEM #	PRINTING OPTIONS	1-4	5-9	10-19	20-49	50+
230327	Full Dye-Sub Printed Peaks + Valances	\$647	\$615	\$582	\$550	\$518
230328	Dye-Sub Printed Front Peak + Front Valance Only	\$560	\$532	\$504	\$476	\$448
230329	Stock Color Top (No Printing)	\$450	\$428	\$405	\$383	\$360

**10' x 10' TENT TOP (600 DENIER POLYESTER) + FRAME**

ITEM #	PRINTING OPTIONS	1-4	5-9	10-19	20-49	50+
230265	Full Dye-Sub Printed Peaks + Valances	\$998	\$948	\$898	\$848	\$798
230279	Dye-Sub Printed Front Peak + Front Valance Only	\$704	\$669	\$634	\$598	\$563
230280	Stock Color Top (No Printing)	\$572	\$543	\$515	\$486	\$458

**10' x 15' TENT TOP (600 DENIER POLYESTER) + FRAME**

ITEM #	PRINTING OPTIONS	1-4	5-9	10-19	20-49	50+
230266	Full Dye-Sub Printed Peaks + Valances	\$1293	\$1228	\$1164	\$1099	\$1,034
230287	Dye-Sub Printed Front Peak + Front Valance Only	\$1057	\$1004	\$951	\$898	\$846
230288	Stock Color Top (No Printing)	\$789	\$750	\$710	\$671	\$631

**10' x 20' TENT TOP (600 DENIER POLYESTER) + FRAME**

ITEM #	PRINTING OPTIONS	1-4	5-9	10-19	20-49	50+
230267	Full Dye-Sub Printed Peaks + Valances	\$1647	\$1565	\$1482	\$1400	\$1318
230295	Dye-Sub Printed Front Peak + Front Valance Only	\$1411	\$1340	\$1270	\$1199	\$1129
230296	Stock Color Top (No Printing)	\$1111	\$1055	\$1000	\$944	\$889 (C)

**PRODUCT SPECIFICATIONS**

SIZE	DIMENSIONS	WEIGHT
5' x 5'	59"W x 118"-130"H x 59"D	34 lbs.
10' x 10'	116"W x 118"-130"H x 116"D	48 lbs.
10' x 15'	172"W x 118"-130"H x 116"D	62 lbs.
10' x 20'	229"W x 118"-130"H x 116"D	85 lbs.

30 sec deployment !!

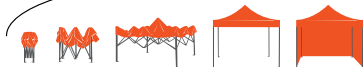

**PRINTING - Dye Sublimation**

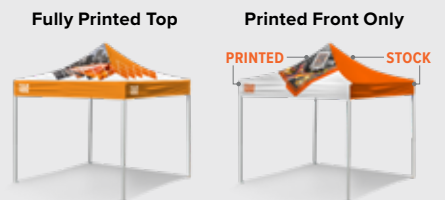



# A HEAVY-DUTY, TRADITIONAL STEEL CUSTOM PRINTED POP-UP TENT



- ✓ A heavy-duty tent that is affordable and strong enough to last you from one event to the next.
- ✓ The strength and dependability of heavy-duty steel at an affordable price.



POP-UP TENTS

## 10' x 10' TENT TOP (600 DENIER POLYESTER) + FRAME

ITEM #	PRINTING OPTIONS	1-4	5-9	10-19	20-49	50+
230256	Full Dye-Sub Printed Peaks + Valances	\$1140	\$1083	\$1026	\$969	\$912
230275	Dye-Sub Printed Front Peak + Front Valance Only	\$845	\$803	\$761	\$718	\$676
230276	Stock Color Top (No Printing)	\$714	\$678	\$643	\$607	\$571

## 10' x 15' TENT TOP (600 DENIER POLYESTER) + FRAME

ITEM #	PRINTING OPTIONS	1-4	5-9	10-19	20-49	50+
230257	Full Dye-Sub Printed Peaks + Valances	\$1422	\$1351	\$1280	\$1209	\$1138
230283	Dye-Sub Printed Front Peak + Front Valance Only	\$1187	\$1128	\$1068	\$1009	\$950
230284	Stock Color Top (No Printing)	\$918	\$872	\$826	\$780	\$734

## 10' x 20' TENT TOP (600 DENIER POLYESTER) + FRAME

ITEM #	PRINTING OPTIONS	1-4	5-9	10-19	20-49	50+
230258	Full Dye-Sub Printed Peaks + Valances	\$1798	\$1708	\$1618	\$1528	\$1438
230291	Dye-Sub Printed Front Peak + Front Valance Only	\$1562	\$1484	\$1406	\$1328	\$1250
230292	Stock Color Top (No Printing)	\$1262	\$1199	\$1136	\$1073	\$1010 (C)



## PRODUCT SPECIFICATIONS

SIZE	DIMENSIONS	WEIGHT
10' x 10'	116"W x 113"-125"H x 116"D	52 lbs.
10' x 15'	172"W x 113"-125"H x 116"D	67 lbs.
10' x 20'	229"W x 113"-125"H x 116"D	91 lbs.

30 sec deployment !!

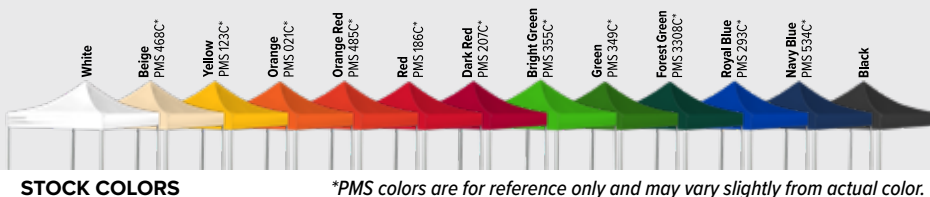

▶ POP-UP TENTS



# A LIGHT AND EASY-TO-CARRY CUSTOM PRINTED POP-UP TENT



- ✓ Commercial anodized aluminum that is versatile and lightweight.
- ✓ An incredibly agile, commercial pop-up tent for simplified use.



**A. HEXAGONAL LEGS** Provide anti-shock resistance that protects every angle of the leg upon impact.

**B. TRUSS BARS** are reinforced with ABS fittings for longer durability and support to the frame.

**C. THUMB LATCH** gives you the choice of selecting between 5 different height adjustments.



**FREE DUST COVER + STAKE KIT INCLUDED**



**10' x 10' TENT TOP (600 DENIER POLYESTER) + FRAME**

ITEM #	PRINTING OPTIONS	1-4	5-9	10-19	20-49	50+
230259	Full Dye-Sub Printed Peaks + Valances	\$1234	\$1172	\$1111	\$1049	\$987
230277	Dye-Sub Printed Front Peak + Front Valance Only	\$939	\$892	\$845	\$798	\$751
230278	Stock Color Top (No Printing)	\$808	\$768	\$727	\$687	\$646



**10' x 15' TENT TOP (600 DENIER POLYESTER) + FRAME**

ITEM #	PRINTING OPTIONS	1-4	5-9	10-19	20-49	50+
230260	Full Dye-Sub Printed Peaks + Valances	\$1530	\$1454	\$1377	\$1301	\$1224
230285	Dye-Sub Printed Front Peak + Front Valance Only	\$1295	\$1230	\$1166	\$1101	\$1036
230286	Stock Color Top (No Printing)	\$1026	\$975	\$923	\$872	\$821



**10' x 20' TENT TOP (600 DENIER POLYESTER) + FRAME**

ITEM #	PRINTING OPTIONS	1-4	5-9	10-19	20-49	50+
230261	Full Dye-Sub Printed Peaks + Valances	\$1982	\$1883	\$1784	\$1685	\$1586
230293	Dye-Sub Printed Front Peak + Front Valance Only	\$1746	\$1659	\$1571	\$1484	\$1397
230294	Stock Color Top (No Printing)	\$1447	\$1375	\$1302	\$1230	\$1158 (C)

**PRODUCT SPECIFICATIONS**

SIZE	DIMENSIONS	WEIGHT
10' x 10'	116"W x 113"-125"H x 116"D	32 lbs.
10' x 15'	172"W x 113"-125"H x 116"D	42 lbs.
10' x 20'	229"W x 113"-125"H x 116"D	58 lbs.

30 sec deployment !!

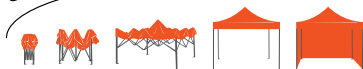

**PRINTING - Dye Sublimation**

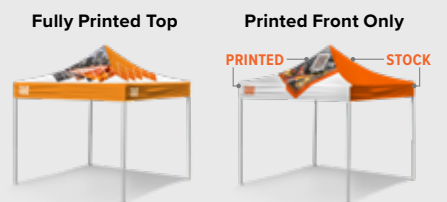





# THE STRONGEST, MOST DURABLE POP-UP TENT IN THE INDUSTRY



- ✓ Ultra strong, aircraft aluminum that is ideal for intense and long-term use.
- ✓ Ideal for all types of terrains such as the mountains, beaches, and parks.



POP-UP TENTS

### 10' x 10' TENT TOP (600 DENIER POLYESTER) + FRAME

ITEM #	PRINTING OPTIONS	1-4	5-9	10-19	20-49	50+
230247	Full Dye-Sub Printed Peaks + Valances	\$1822	\$1731	\$1640	\$1549	\$1458
230273	Dye-Sub Printed Front Peak + Front Valance Only	\$1528	\$1452	\$1375	\$1299	\$1222
230274	Stock Color Top (No Printing)	\$1396	\$1326	\$1256	\$1187	\$1117

### 10' x 15' TENT TOP (600 DENIER POLYESTER) + FRAME

ITEM #	PRINTING OPTIONS	1-4	5-9	10-19	20-49	50+
230248	Full Dye-Sub Printed Peaks + Valances	\$2364	\$2246	\$2128	\$2009	\$1891
230281	Dye-Sub Printed Front Peak + Front Valance Only	\$2128	\$2022	\$1915	\$1809	\$1702
230282	Stock Color Top (No Printing)	\$1860	\$1767	\$1674	\$1581	\$1488

### 10' x 20' TENT TOP (600 DENIER POLYESTER) + FRAME

ITEM #	PRINTING OPTIONS	1-4	5-9	10-19	20-49	50+
230249	Full Dye-Sub Printed Peaks + Valances	\$3043	\$2891	\$2739	\$2587	\$2434
230289	Dye-Sub Printed Front Peak + Front Valance Only	\$2808	\$2668	\$2527	\$2387	\$2246
230290	Stock Color Top (No Printing)	\$2507	\$2382	\$2256	\$2131	\$2006 (C)



### PRODUCT SPECIFICATIONS

SIZE	DIMENSIONS	WEIGHT
10' x 10'	116"W x 123"-129"H x 116"D	50 lbs.
10' x 15'	172"W x 123"-129"H x 116"D	63 lbs.
10' x 20'	229"W x 123"-129"H x 116"D	86 lbs.

30 sec deployment !!

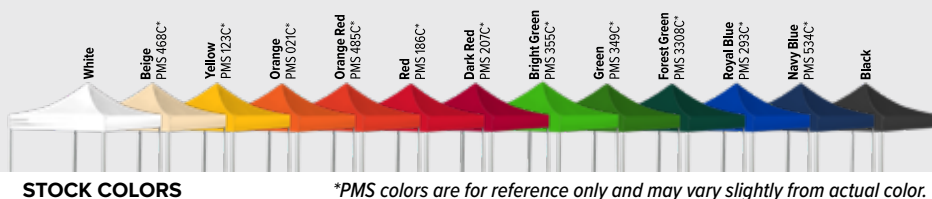

## WALL OPTIONS

### Wall

#### SINGLE-SIDED FULL DYE-SUB PRINT

ITEM #	SIZE	1-4	5-9	10-19	20-49	50+
230225	10'	\$304	\$289	\$274	\$258	\$243
230232	15'	\$422	\$401	\$380	\$359	\$338
230234	20'	\$553	\$525	\$498	\$470	\$442

#### DOUBLE-SIDED FULL DYE-SUB PRINT

ITEM #	SIZE	1-4	5-9	10-19	20-49	50+
230224	10'	\$609	\$579	\$548	\$518	\$487
230231	15'	\$844	\$802	\$760	\$717	\$675

#### STOCK COLOR

ITEM #	SIZE	1-4	5-9	10-19	20-49	50+
230212	10'	\$177	\$168	\$159	\$150	\$142
230218	15'	\$256	\$243	\$230	\$218	\$205

#### PRODUCT SPECIFICATIONS

SIZE	DIMENSIONS	WEIGHT
10'	116"W × 79"H	4 lbs.
15'	172"W × 79"H	6 lbs.
20'	229"W × 79"H	8 lbs.

*\*Weights for Single-Sided & Stock Items*



(C)

### Wall with Door

#### SINGLE-SIDED FULL DYE-SUB PRINT

ITEM #	SIZE	1-4	5-9	10-19	20-49	50+
230223	10'	\$368	\$350	\$331	\$313	\$294
230230	15'	\$486	\$462	\$437	\$413	\$389

#### STOCK COLOR

ITEM #	SIZE	1-4	5-9	10-19	20-49	50+
230213	10'	\$241	\$229	\$217	\$205	\$193
230219	15'	\$320	\$304	\$288	\$272	\$256

#### PRODUCT SPECIFICATIONS

SIZE	DIMENSIONS	WEIGHT
10'	116"W × 79"H	4 lbs.
15'	172"W × 79"H	6 lbs.
20'	229"W × 79"H	8 lbs.



### Awning (V3 Only)

#### SINGLE-SIDED FULL DYE-SUB PRINT + HARDWARE

ITEM #	SIZE	1-4	5-9	10-19	20-49	50+
230298	10'	\$720	\$684	\$648	\$612	\$576

#### STOCK COLOR + HARDWARE

ITEM #	SIZE	1-4	5-9	10-19	20-49	50+
230299	10'	\$691	\$656	\$622	\$587	\$553

#### PRODUCT SPECIFICATIONS

SIZE	DIMENSIONS	WEIGHT
10'	116"W × 30"D	10 lbs.



## WALL OPTIONS

### Railskirt with Hardware (Pole + Clamps)

#### SINGLE-SIDED FULL DYE-SUB PRINT + HARDWARE

V3 ITEM #	V4 ITEM #	V5 ITEM #	SIZE	1-4	5-9	10-19	20-49	50+
230255	230264	230270	10'	\$292	\$277	\$263	\$248	\$234
230302	230304	230306	15'	\$456	\$433	\$410	\$388	\$365

#### DOUBLE-SIDED FULL DYE-SUB PRINT + HARDWARE

V3 ITEM #	V4 ITEM #	V5 ITEM #	SIZE	1-4	5-9	10-19	20-49	50+
230254	230263	230269	10'	\$480	\$456	\$432	\$408	\$384
230303	230305	230307	15'	\$750	\$713	\$675	\$638	\$600

#### STOCK COLOR + HARDWARE

V3 ITEM #	V4 ITEM #	V5 ITEM #	SIZE	1-4	5-9	10-19	20-49	50+
230308	230310	230312	10'	\$213	\$202	\$192	\$181	\$170
230309	230311	230313	15'	\$340	\$323	\$306	\$289	\$272 (C)

#### PRODUCT SPECIFICATIONS

SIZE	DIMENSIONS	WEIGHT	SIZE	DIMENSIONS	WEIGHT	SIZE	DIMENSIONS	WEIGHT
V3 10'	117"W × 37"H	8 lbs.	V4 10'	117"W × 37"H	5 lbs.	V5 10'	117"W × 37"H	5 lbs.
V3 15'	170"W × 37"H	10 lbs.	V4 15'	170"W × 37"H	10 lbs.	V5 15'	170"W × 37"H	10 lbs.

\*Weights for Single-Sided & Stock Items



### Wall with Window (Clear Vinyl)

#### SINGLE-SIDED FULL DYE-SUB PRINT

ITEM #	SIZE	1-4	5-9	10-19	20-49	50+
230226	10'	\$368	\$350	\$331	\$313	\$294
230233	15'	\$486	\$462	\$437	\$413	\$389

#### STOCK COLOR

ITEM #	SIZE	1-4	5-9	10-19	20-49	50+
230214	10'	\$241	\$229	\$217	\$205	\$193
230220	15'	\$320	\$304	\$288	\$272	\$239 (C)

#### PRODUCT SPECIFICATIONS

SIZE	DIMENSIONS	WEIGHT
10'	116"W × 79"H	4 lbs.
15'	172"W × 79"H	6 lbs.
20'	229"W × 79"H	9 lbs.



### Counter (V3 Only)

#### SINGLE-SIDED FULL DYE-SUB PRINT + HARDWARE

ITEM #	SIZE	1-4	5-9	10-19	20-49	50+
230250	10'	\$1,188	\$1,129	\$1,069	\$1,010	\$950

#### STOCK COLOR + HARDWARE

ITEM #	SIZE	1-4	5-9	10-19	20-49	50+
230297	10'	\$1,127	\$1,071	\$1,014	\$958	\$902 (C)

#### PRODUCT SPECIFICATIONS

SIZE	DIMENSIONS	WEIGHT
10'	116"W × 42.5"H × 14"D	32 lbs.



**A. EXTRUDED ALUMINUM FRAME**  
For ultimate durability & weight resistance. Holds up to 100 lbs.

**B. MULTI-FUNCTIONAL COUNTER**  
Can be used to serve food and beverages or to showcase products.



## ▶ POP-UP TENTS

### ACCESSORIES

#### PREMIUM ROLLER BAG

ITEM #	SIZE	1-4	5-9	10-19	20-49	50+
230026	10' x 10'	\$108	\$103	\$97	\$92	\$86
230027	10' x 15'	\$126	\$120	\$113	\$107	\$101
230028	10' x 20'	\$173	\$164	\$156	\$147	\$138 (C)



#### PREMIUM ROLLER BAG

Travel bag with wheels that is ideal to easily transport your pop-up tent.



#### TENT HARD CASE

Durable carry case with wheels to protect, transport & store your pop-up tent.



#### WALL BAG

Store, transport & protect your tent walls with this soft bag. It fits up to 4 walls.

#### TENT HARD CASE (10'x10' & 10'x15')

ITEM #	1-4	5-9	10-19	20-49	50+
230018	\$385	\$366	\$347	\$327	\$308

#### WALL BAG

ITEM #	1-4	5-9	10-19	20-49	50+
230033	\$77	\$73	\$69	\$65	\$62

#### RAILSKIRT BAG

ITEM #	1-4	5-9	10-19	20-49	50+
230025	\$77	\$73	\$69	\$65	\$62 (C)



#### RAILSKIRT BAG

Store, transport and protect your railskirt fabric & poles with this soft bag.



## ACCESSORIES

### PRO STAKES (SET OF 4)

ITEM #	1-4	5-9	10-19	20-49	50+
230246	\$24	\$24	\$20	\$20	\$20

### EASY RATCHET

ITEM #	1-4	5-9	10-19	20-49	50+
230023	\$27	\$26	\$24	\$23	\$22

### HEAVY WINDS STAKE KIT (4 ROPES + 4 RATCHETS + 4 STAKES)

ITEM #	1-4	5-9	10-19	20-49	50+
230201	\$92	\$87	\$83	\$78	\$74

### 30 lbs RUBBER WEIGHT

ITEM #	1-4	5-9	10-19	20-49	50+
230003	\$81	\$77	\$73	\$69	\$65

### SAND BAGS (SET OF 4)

ITEM #	1-4	5-9	10-19	20-49	50+
230245	\$96	\$91	\$86	\$82	\$77

### RECHARGEABLE LIGHT

ITEM #	1-4	5-9	10-19	20-49	50+
230019	\$79	\$75	\$71	\$67	\$63

### FLAG HOLDER

ITEM #	SIZE	1-4	5-9	10-19	20-49	50+
150007	V3/V4	\$51	\$48	\$46	\$43	\$41
150008	V5	\$51	\$48	\$46	\$43	\$41



#### PRO STAKES

These 4 professional 18" x 1/2" stakes are designed to hold your tent in place in case of heavy winds.



#### EASY RATCHET

This professional 3/8" ratchet and 10" rope can hold up to 250 lbs. It comes with an automatic lock and release system to keep or release the tension easily.



#### FLAG HOLDER

This flag holder attaches to the canopy's leg.



#### 30 lbs RUBBER WEIGHT

30 lbs ballast weight to secure your canopy on asphalt or on any flat surface.

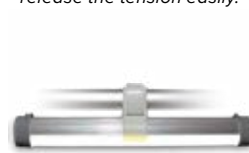

#### RECHARGEABLE LIGHT

Add instant lighting with this LED light. Lasts up to 8 hours.



#### SAND BAGS

Set of 4 soft sand bags can be filled with up to 20 lbs of sand.

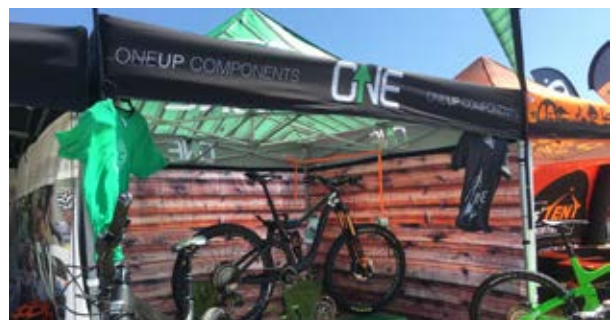

SPECIALIZED TENTS



THE FINEST TENT IN THE INDUSTRY WITH EXCLUSIVE GAS SPRING TECHNOLOGY

SPECIALIZED TENTS



**✓ PATENTED TECHNOLOGY**  
Each leg has two gas springs to facilitate the tent's deployment.

**PRODUCT SPECIFICATIONS**

SIZE	DIMENSIONS	WEIGHT
13' x 13'	116"W x 162"-176"H x 116"D	223 lbs.
17' x 17'	116"W x 169"H x 116"D	264 lbs.



**13' x 13' TENT TOP (600 DENIER POLYESTER) + FRAME**

ITEM #	PRINTING OPTIONS	1-4	5-9	10-19	20-49	50+
250235	Full Dye-Sub Printed Peaks + Valances	\$5875	\$5581	\$5288	\$4994	\$4700



**17' x 17' TENT TOP (600 DENIER POLYESTER) + FRAME**

ITEM #	PRINTING OPTIONS	1-4	5-9	10-19	20-49	50+
250236	Full Dye-Sub Printed Peaks + Valances	\$8477	\$8053	\$7629	\$7205	\$6782

(C)

**PRINTING - Dye Sublimation**

**Fully Printed Top**

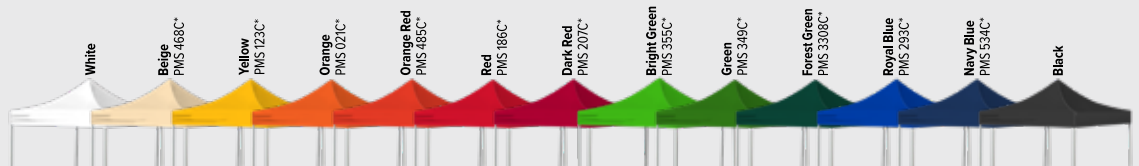

**STOCK COLORS**

*\*PMS colors are for reference only and may vary slightly from actual color.*



## WALL OPTIONS

### Wall

#### SINGLE-SIDED FULL DYE-SUB PRINT (600 DENIER POLYESTER)

ITEM #	SIZE	1-4	5-9	10-19	20-49	50+
250117	13'	\$400	\$380	\$360	\$340	\$320
250229	17'	\$526	\$500	\$473	\$447	\$421

#### DOUBLE-SIDED FULL DYE-SUB PRINT (600 DENIER POLYESTER)

ITEM #	SIZE	1-4	5-9	10-19	20-49	50+
250237	13'	\$800	\$760	\$720	\$680	\$640
250238	17'	\$1,051	\$998	\$946	\$893	\$841

#### STOCK COLOR (VINYL)

ITEM #	SIZE	1-4	5-9	10-19	20-49	50+
250220	13'	\$318	\$302	\$286	\$270	\$254
250232	17'	\$412	\$391	\$371	\$350	\$330



#### PRODUCT SPECIFICATIONS

SIZE	DIMENSIONS	WEIGHT
13'	156"W × 85"H	13 lbs.*
17'	197"W × 98"H	16 lbs.*

\*Weights for Polyester Single-Sided & Stock Items

### Wall with Window (Clear Vinyl)

#### SINGLE-SIDED FULL DYE-SUB PRINT (600 DENIER POLYESTER)

ITEM #	SIZE	1-4	5-9	10-19	20-49	50+
250119	13'	\$449	\$427	\$404	\$382	\$359
250231	17'	\$564	\$536	\$508	\$479	\$451

#### STOCK COLOR (VINYL)

ITEM #	SIZE	1-4	5-9	10-19	20-49	50+
250222	13'	\$425	\$404	\$383	\$361	\$340
250234	17'	\$519	\$493	\$467	\$441	\$415



#### PRODUCT SPECIFICATIONS

SIZE	DIMENSIONS	WEIGHT
13'	156"W × 85"H	13 lbs.*
17'	197"W × 98"H	16 lbs.*

\*Weights for Polyester Single-Sided & Stock Items

### Wall with Door

#### SINGLE-SIDED FULL DYE-SUB PRINT (600 DENIER POLYESTER)

ITEM #	SIZE	1-4	5-9	10-19	20-49	50+
250118	13'	\$449	\$427	\$404	\$382	\$359
250230	17'	\$564	\$536	\$508	\$479	\$451

#### STOCK COLOR (VINYL)

ITEM #	SIZE	1-4	5-9	10-19	20-49	50+
250221	13'	\$425	\$404	\$383	\$361	\$340
250233	17'	\$519	\$493	\$467	\$441	\$415



#### PRODUCT SPECIFICATIONS

SIZE	DIMENSIONS	WEIGHT
13'	156"W × 85"H	13 lbs.*
17'	197"W × 98"H	16 lbs.*

\*Weights for Polyester Single-Sided & Stock Items

▶ AIRDOME

# AirDOME™



- ✓ Dacron® Outer Tube For Extensive Protection
- ✓ Polyurethane Inner Tube With Airtight Technology – AIT (Airtight Inner Tube)

**B. OVER PRESSURE VALVES**

The valve system will automatically release excess air when the optimum pressure is reached.



**C. STAINLESS STEEL BALLAST CONNECTIONS**

Reinforced anchoring system for securing your inflatable event dome tent on different terrains.



**D. HEAVY DUTY WALL ZIPPERS**

Allows walls and windows to be easily added.



**A. FAST AIRFLOW ONE-WAY VALVE**

Fast inflating valve system guarantees that no air will escape when you unplug your air pump. No continuous air supply needed.

**E. HAND PUMP, PRO STAKES & TRANSPORT BAG INCLUDED**



**PRODUCT SPECIFICATIONS**

SIZE	DIMENSIONS	WEIGHT
10' x 10'	125"W x 125"D x 94"H	33 lbs.
13' x 13'	157"W x 157"D x 106"H	40 lbs.
17' x 17'	191"W x 191"D x 129"H	55 lbs.
20' x 20'	232"W x 232"D x 158"H	120 lbs.
26' x 26'	319"W x 319"D x 209"H	165 lbs.

**SIZE OPTIONS**



**FULL DYE-SUB PRINTED TOP (600 DENIER POLYESTER) + FRAME**

ITEM #	SIZE	1-4	5-9	10-19	20-49	50+
100074	10' x 10'	\$2715	\$2579	\$2444	\$2308	\$2172
100075	13' x 13'	\$3417	\$3246	\$3075	\$2904	\$2734
100076	17' x 17'	\$4303	\$4088	\$3873	\$3658	\$3442
100112	20' x 20'	\$12185	\$11576	\$10967	\$10357	\$9748
100113	26' x 26'	\$16687	\$15853	\$15018	\$14184	\$13350

**STOCK COLOR TOP (600 DENIER POLYESTER) + FRAME**

ITEM #	SIZE	1-4	5-9	10-19	20-49	50+
100077	10' x 10'	\$2087	\$1983	\$1878	\$1774	\$1670
100078	13' x 13'	\$2632	\$2500	\$2369	\$2237	\$2106
100079	17' x 17'	\$3440	\$3268	\$3096	\$2924	\$2752
100114	20' x 20'	\$10499	\$9974	\$9449	\$8924	\$8399
100115	26' x 26'	\$13935	\$13238	\$12542	\$11845	\$11148 (C)

**SET UP STEPS**



**STOCK COLORS**

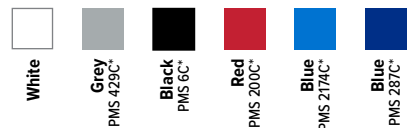

\*PMS colors are for reference only and may vary slightly from actual color.

## WALL OPTIONS

### Wall

#### SINGLE-SIDED FULL DYE-SUB PRINT

ITEM #	SIZE	1-4	5-9	10-19	20-49	50+
100057	10'	\$356	\$338	\$320	\$303	\$285
100062	13'	\$428	\$407	\$385	\$364	\$342
100067	17'	\$569	\$541	\$512	\$484	\$455
100108	20'	\$827	\$786	\$744	\$703	\$662
100109	26'	\$1072	\$1018	\$965	\$911	\$858

#### DOUBLE-SIDED FULL DYE-SUB PRINT

ITEM #	SIZE	1-4	5-9	10-19	20-49	50+
100056	10'	\$856	\$813	\$770	\$728	\$685
100061	13'	\$1027	\$976	\$924	\$873	\$822
100066	17'	\$1373	\$1304	\$1236	\$1167	\$1098
100116	20'	\$1654	\$1571	\$1489	\$1406	\$1323
100117	26'	\$2144	\$2037	\$1930	\$1822	\$1715

#### STOCK COLOR

ITEM #	SIZE	1-4	5-9	10-19	20-49	50+
100059	10'	\$141	\$134	\$127	\$120	\$113
100064	13'	\$173	\$164	\$156	\$147	\$138
100069	17'	\$235	\$223	\$212	\$200	\$188
100110	20'	\$612	\$581	\$551	\$520	\$490
100111	26'	\$733	\$696	\$660	\$623	\$586

(C)



#### PRODUCT SPECIFICATIONS

SIZE	DIMENSIONS	WEIGHT
10'	134"W × 91"H	4 lbs.
13'	156"W × 100"H	4 lbs.
17'	188"W × 113"H	5 lbs.
20'	211"W × 113"H	5 lbs.
26'	279"W × 157"H	6 lbs.

*\*Weights for Single-Sided & Stock Items*

### Wall with Window (Clear Vinyl)

#### SINGLE-SIDED FULL DYE-SUB PRINT

ITEM #	SIZE	1-4	5-9	10-19	20-49	50+
100058	10'	\$380	\$361	\$342	\$323	\$304
100063	13'	\$439	\$417	\$395	\$373	\$351
100068	17'	\$596	\$566	\$536	\$507	\$477
100118	20'	\$891	\$846	\$802	\$757	\$713
100119	26'	\$1136	\$1079	\$1022	\$966	\$909

#### STOCK COLOR

ITEM #	SIZE	1-4	5-9	10-19	20-49	50+
100060	10'	\$164	\$156	\$148	\$139	\$131
100065	13'	\$184	\$175	\$166	\$156	\$147
100070	17'	\$262	\$249	\$236	\$223	\$210
100120	20'	\$676	\$642	\$608	\$575	\$541
100121	26'	\$797	\$757	\$717	\$677	\$638

(C)



#### PRODUCT SPECIFICATIONS

SIZE	DIMENSIONS	WEIGHT
10'	122"W × 89"H	4 lbs.
13'	153"W × 110"H	5 lbs.
17'	186"W × 135"H	6 lbs.
20'	211"W × 113"H	6 lbs.
26'	279"W × 157"H	7 lbs.

### Awning

#### SINGLE-SIDED FULL DYE-SUB PRINT + HARDWARE

ITEM #	SIZE	1-4	5-9	10-19	20-49	50+
100080	10'	\$667	\$634	\$600	\$567	\$534
100081	13'	\$784	\$745	\$706	\$666	\$627
100082	17'	\$1052	\$999	\$947	\$894	\$842

#### STOCK COLOR + HARDWARE

ITEM #	SIZE	1-4	5-9	10-19	20-49	50+
100083	10'	\$490	\$466	\$441	\$417	\$392
100084	13'	\$569	\$541	\$512	\$484	\$455
100085	17'	\$687	\$653	\$618	\$584	\$550

(C)



#### PRODUCT SPECIFICATIONS

SIZE	DIMENSIONS	WEIGHT
10'	122"W × 89"H	9 lbs.
13'	153"W × 110"H	13 lbs.
17'	186"W × 135"H	18 lbs.



## WALL OPTIONS

### Awning Banner

#### SINGLE-SIDED FULL DYE-SUB PRINT

ITEM #	SIZE	1-4	5-9	10-19	20-49	50+
100017	10'	\$98	\$93	\$88	\$83	\$78
100023	13'	\$137	\$130	\$123	\$116	\$110
100029	17'	\$268	\$255	\$241	\$228	\$214

#### STOCK COLOR

ITEM #	SIZE	1-4	5-9	10-19	20-49	50+
100018	10'	\$98	\$93	\$88	\$83	\$78
100024	13'	\$137	\$130	\$123	\$116	\$110
100030	17'	\$268	\$255	\$241	\$228	\$214



#### PRODUCT SPECIFICATIONS

SIZE	DIMENSIONS	WEIGHT
10'	53"W × 15"H	1 lbs.
13'	83"W × 24"H	1 lbs.
17'	103"W × 33"H	1 lbs.

### Connector

#### SINGLE-SIDED FULL DYE-SUB PRINT

ITEM #	SIZE	1-4	5-9	10-19	20-49	50+
100032	10' × 10' to 10' × 10'	\$378	\$359	\$340	\$321	\$302
100034	10' × 10' to 13' × 13'	\$685	\$651	\$617	\$582	\$548
100036	10' × 10' to 17' × 17'	\$835	\$793	\$752	\$710	\$668
100038	13' × 13' to 13' × 13'	\$589	\$560	\$530	\$501	\$471
100040	13' × 13' to 17' × 17'	\$749	\$712	\$674	\$637	\$599
100042	17' × 17' to 17' × 17'	\$706	\$671	\$635	\$600	\$565

#### STOCK COLOR

ITEM #	SIZE	1-4	5-9	10-19	20-49	50+
100033	10' × 10' to 10' × 10'	\$255	\$242	\$230	\$217	\$204
100035	10' × 10' to 13' × 13'	\$330	\$314	\$297	\$281	\$264
100037	10' × 10' to 17' × 17'	\$391	\$371	\$352	\$332	\$313
100039	13' × 13' to 13' × 13'	\$294	\$279	\$265	\$250	\$235
100041	13' × 13' to 17' × 17'	\$335	\$318	\$302	\$285	\$268
100043	17' × 17' to 17' × 17'	\$353	\$335	\$318	\$300	\$282

#### PRODUCT SPECIFICATIONS

SIZE	DIMENSIONS	WEIGHT
10' × 10' to 10' × 10'	51"W × 221"H	3 lbs.
10' × 10' to 13' × 13'	73"W × 245"H	6 lbs.
10' × 10' to 17' × 17'	101"W × 278"H	8 lbs.
13' × 13' to 13' × 13'	65"W × 277"H	4 lbs.
13' × 13' to 17' × 17'	85"W × 295"H	5 lbs.
17' × 17' to 17' × 17'	77"W × 310"H	6 lbs.



## ACCESSORIES

### ELECTRIC PUMP

ITEM #	1-4	5-9	10-19	20-49	50+
160002	\$70	\$67	\$63	\$60	\$56

### HAND PUMP

ITEM #	1-4	5-9	10-19	20-49	50+
160005	\$32	\$30	\$29	\$27	\$26

### 30 lbs RUBBER WEIGHT

ITEM #	1-4	5-9	10-19	20-49	50+
230003	\$81	\$77	\$73	\$69	\$65 (C)

### PRO STAKES (SET OF 4)

ITEM #	1-4	5-9	10-19	20-49	50+
230246	\$24	\$24	\$20	\$20	\$20

### EASY RATCHET

ITEM #	1-4	5-9	10-19	20-49	50+
230023	\$27	\$26	\$24	\$23	\$22

### HEAVY WINDS STAKE KIT (4 ROPES + 4 RATCHETS + 4 STAKES)

ITEM #	1-4	5-9	10-19	20-49	50+
230201	\$92	\$87	\$83	\$78	\$74 (C)



**ELECTRIC PUMP**  
The fastest solution for inflating your inflatable equipment.



**HAND PUMP**  
Manually inflate your Airdome without the need of electricity.



**30 lbs RUBBER WEIGHT**  
The perfect solution for securing your tents, flags or umbrellas on asphalt or on any flat surface.



**PRO STAKES**  
These 4 professional 18" x 1/2" stakes are designed to hold your tent in place in case of heavy winds.



**EASY RATCHET**  
This professional 3/8" ratchet and 10" rope can hold up to 250 lbs. It comes with an automatic lock and release system to keep or release the tension easily.



**HEAVY WINDS STAKE KIT**  
This heavy wind stake kit includes 4 professional stakes, 4 ropes and 4 ratchets.



# AIR TENT

**A. Ultra Strong DACRON FRAME**

**B. POLYURETHANE BLADDER** that is puncture resistant

**C. AIRTIGHT INNER TUBE TECHNOLOGY** to keep air sealed inside

**D. STAINLESS STEEL BALLAST CONNECTIONS**  
Reinforced anchoring system for securing your tent on different terrains.

**E. OVER PRESSURE VALVES**  
The valve system will automatically release excess air when the optimum pressure is reached.

**F. CUSTOM FRAME OPTIONS**  
select from 5 different colors to give your Air Tent a unique presentation.

**G. FAST AIRFLOW ONE-WAY VALVE**  
Fast Inflating valve system with unidirectional air flow for fast set up.

**H. FREE Electric Pump, Carrying Bag, and Stakes**



## SIZES OPTIONS

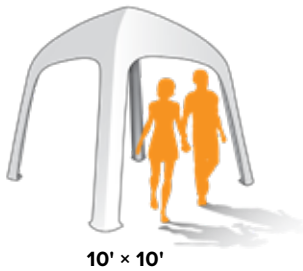

10' x 10'

## WALL OPTIONS



Wall

Wall with Door

Wall with Window

## PRODUCT SPECIFICATIONS

OUTER DIMENSIONS 120"W x 120"D x 108"H  
INSIDE DIMENSIONS 104"W x 104"D x 101"H  
FRAME WEIGHT 15 lbs.  
WALL WEIGHT 11 lbs.

## STOCK COLORS

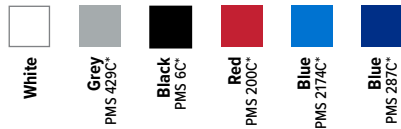

## FRAME COLORS

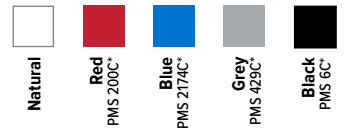

\* PMS colors are for reference only and may vary slightly from actual color.



## 10' x 10' FRAME + 600 DENIER POLYESTER TOP (WITH TRANSPORT BAG & STAKES)

ITEM #	SIZE	1-4	5-9	10-19	20-49	50+
100101	10' x 10' Frame + Solid Color Top	\$1436	\$1364	\$1292	\$1221	\$1149
100100	10' x 10' Frame + Printed Top	\$1710	\$1625	\$1539	\$1454	\$1368

## SINGLE-SIDED 10' WALL (600 DENIER POLYESTER)

ITEM #	SIZE	1-4	5-9	10-19	20-49	50+
100093	10' Wall Solid Color	\$184	\$175	\$166	\$156	\$147
100098	10' Wall with Door Solid Color	\$211	\$200	\$190	\$179	\$169
100096	10' Wall with Window Solid Color	\$211	\$200	\$190	\$179	\$169
100094	10' Wall Printed	\$310	\$295	\$279	\$264	\$248
100099	10' Wall with Door Printed	\$337	\$320	\$303	\$286	\$270
100097	10' Wall with Window Printed	\$337	\$320	\$303	\$286	\$270

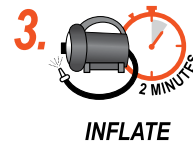
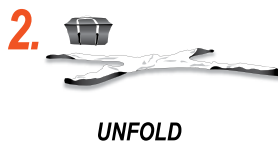



**A. Ultra Strong & Durable DACRON FRAME**

**B. POLYURETHANE BLADDER** that is puncture resistant

**C. AIRTIGHT INNER TUBE TECHNOLOGY** to keep air sealed inside

**D. FAST AIRFLOW ONE-WAY VALVE**  
Fast Inflating valve system with unidirectional air flow for fast set up.

**E. CUSTOM FRAME OPTIONS**  
select from 5 different colors to give your AirWave a unique presentation.

**F. OVER PRESSURE VALVES**  
The valve system will automatically release excess air when the optimum pressure is reached.

**G. FREE Electric Pump, Carrying Bag, and Stakes**

**SIZES OPTIONS**

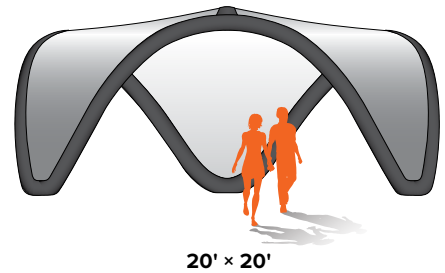
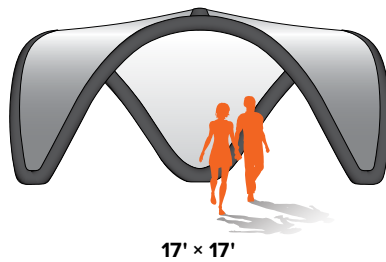
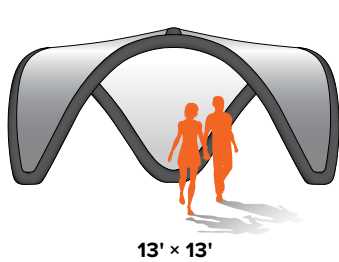

**STOCK COLORS**

- White
- Grey  
PMS 429C\*
- Black  
PMS 6C\*
- Red  
PMS 200C\*
- Blue  
PMS 2174C\*
- Blue  
PMS 287C\*

**FRAME COLORS**

- Natural
- Red  
PMS 200C\*
- Blue  
PMS 2174C\*
- Grey  
PMS 429C\*
- Black  
PMS 6C\*

**PRODUCT SPECIFICATIONS**

SIZE	OUTSIDE DIMENSIONS	INSIDE DIMENSIONS	WEIGHT
13'x13'	167"W x 167"L x 105"H	152"W x 152"L x 97"H	62 lbs.
17'x17'	207"W x 207"L x 122"H	188"W x 188"L x 113"H	71 lbs.
20'x20'	244"W x 244"L x 130"H	224"W x 224"L x 120"H	95 lbs.

\* PMS colors are for reference only and may vary slightly from actual color.

**TENT FRAME + 600 DENIER POLYESTER TOP (WITH TRANSPORT BAG & STAKES)**

ITEM #	SIZE	1-4	5-9	10-19	20-49	50+
110037	13' x 13' Frame + Solid Color Top	\$3663	\$3480	\$3297	\$3114	\$2930
110038	13' x 13' Frame + Printed Top	\$4428	\$4207	\$3985	\$3764	\$3542
110039	17' x 17' Frame + Solid Color Top	\$4487	\$4263	\$4038	\$3814	\$3590
110040	17' x 17' Frame + Printed Top	\$5428	\$5157	\$4885	\$4614	\$4342
110041	20' x 20' Frame + Solid Color Top	\$5280	\$5016	\$4752	\$4488	\$4224
110042	20' x 20' Frame + Printed Top	\$6434	\$6112	\$5791	\$5469	\$5147

- 1.**

**TRAVEL**
- 2.**

**UNFOLD**
- 3.** 2 MINUTES

**INFLATE**
- 4.**

**ENJOY**





CHAIR

OTTOMAN/  
COFFEE TABLE

SOFA

**NEOPRENE COVERS WITH FULL DYE-SUBLIMATION PRINTING**  
Ideal for multiple terrains & variable weather conditions (water repellent).

**VALVE & BLADDER**  
One single valve to inflate and deflate for faster set up and take down. No continuous air supply needed.

**STRONG BOTTOM MATERIAL & ZIPPER**

**HIGH-QUALITY MATERIAL BLADDER**  
The strongest puncture resistant material in the market (.45mm TPU).



**ELECTRIC PUMP**  
The fastest solution for inflating your equipment

**CARRYING BAG**  
Fits up to 2 inflatable furniture pieces + pump

**SETUP STEPS**

1. UNFOLD
2. INFLATE  
3 minutes
3. ADD THE COVER

**ELECTRIC PUMP**

ITEM #	1-4	5-9	10-19	20-49	50+
160002	\$70	\$67	\$63	\$60	\$56

**CARRYING BAG**

ITEM #	1-4	5-9	10-19	20-49	50+
160004	\$70	\$67	\$63	\$60	\$56 (C)



## Full Dye-Sub Printed Covers + Bladders

### AIR'LOUNGE SET (1 SOFA, 1 CHAIR, 1 OTTOMAN & 1 ELECTRIC PUMP)

ITEM #	1-4	5-9	10-19	20-49	50+
110013	\$1807	\$1717	\$1626	\$1536	\$1446

### SOFA

ITEM #	1-4	5-9	10-19	20-49	50+
110009	\$866	\$823	\$779	\$736	\$693

### CHAIR

ITEM #	1-4	5-9	10-19	20-49	50+
110010	\$610	\$580	\$549	\$519	\$488

### OTTOMAN

ITEM #	1-4	5-9	10-19	20-49	50+
110011	\$369	\$351	\$332	\$314	\$295

### COFFEE TABLE (WITH CLEAR ACRYLIC TABLE TOP)

ITEM #	1-4	5-9	10-19	20-49	50+
110012	\$409	\$389	\$368	\$348	\$327 (C)

### PRODUCT SPECIFICATIONS

ITEM	DIMENSIONS	WEIGHT
Sofa	74"W x 31"H x 30"D	18 lbs.
Chair	42"W x 31"H x 30"D	12 lbs.
Ottoman	27"W x 17"H x 27"D	4 lbs.
Clear Acrylic Table Top	19"Diameter x 0.3"Thick	3 lbs.



### OTTOMAN OR COFFEE TABLE

Use as an ottoman seat or convert to coffee table with clear acrylic sheet.



SEATS 3



SEATS 1

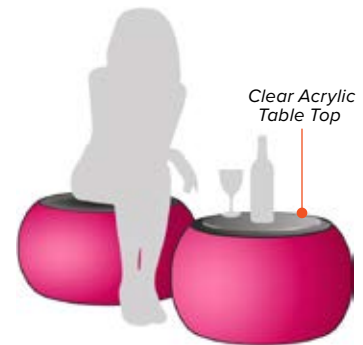

USE AS OTTOMAN SEAT OR TABLE





▶ AIR DISPLAY COUNTER



# A COUNTER THAT ELEVATES YOUR DISPLAY

The Air Display Counters brighten up any booth with its programmable LED lights that illuminate the counters from within turning into an attractive counter. It easily inflates via a valve in just under a minute making it easy for your events. It's made from durable materials such a polyurethane bladder that is puncture resistant and a circular wood counter top that is strong enough to hold multiple items.

**SIZES OPTIONS**



**SMALL**



**LARGE**



**A** **PRINT ANY DESIGN**  
on the PU coated 600 denier cover



**B** **PROGRAMMABLE LED LIGHTS**  
that change color (last up to 4hrs).



**C** **BATTERY OPERATED REMOTE**  
to change LED lights.



**D** **HEAVY DUTY WOOD CIRCULAR COUNTER**



**E** **POLYURETHANE BLADDER** that is puncture resistant for lasting durability

**SMALL COUNTER**

ITEM #	DESCRIPTION	1-4	5-9	10-19	20-49	50+
110035	Small Air Display Counter with Full Dye Sublimation	\$890	\$846	\$801	\$757	\$712
110036	LED Light Option	\$142	\$135	\$128	\$121	\$114 (C)



**PRODUCT SPECIFICATIONS**  
SIZE 43"H x 24"Diameter (Top) x 18"Diameter (Bottom)  
WEIGHT 15 lbs.

**LARGE COUNTER**

ITEM #	DESCRIPTION	1-4	5-9	10-19	20-49	50+
110034	Large Air Display Counter with Full Dye Sublimation	\$1008	\$958	\$907	\$857	\$806
110036	LED Light Option	\$142	\$135	\$128	\$121	\$114 (C)



**PRODUCT SPECIFICATIONS**  
SIZE 43"H x 32"Diameter (Top) x 24"Diameter (Bottom)  
WEIGHT 21 lbs.



## A HIGHLY EYE-CATCHING DISPLAY

This attractive display takes your brand to new heights. The Air Tower is air sealed and can be completely customized with any design to make this a colorful display of your brand. It quickly inflates in just under a minute via a valve that is easy to inflate while the air remains sealed. The Air Tower has an inner polyurethane bladder that is puncture resistant to last you for many events. You also have the option of adding programmable LED lights that change color to take your display to the next level.

### SIZES OPTIONS

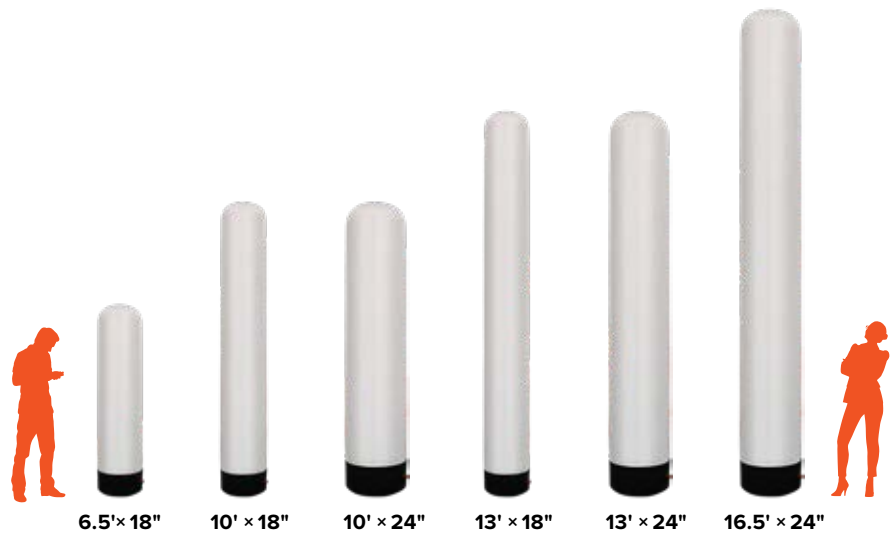

INFLATABLES



**PRINT ANY DESIGN**  
on the PU coated 600  
denier cover



**PROGRAMMABLE  
LED LIGHTS** that change  
color (last up to 4hrs)



**BATTERY OPERATED  
REMOTE**  
to change LED lights



**POLYURETHANE BLADDER**  
that is puncture resistant for  
lasting durability

### AIR TOWER

ITEM #	DESCRIPTION	1-4	5-9	10-19	20-49	50+
110014	6.5' x 18" Air Tower	\$883	\$839	\$795	\$751	\$706
110015	10' x 18" Air Tower	\$1,102	\$1,047	\$992	\$937	\$882
110016	10' x 24" Air Tower	\$1452	\$1379	\$1307	\$1234	\$1162
110017	13' x 18" Air Tower	\$1356	\$1288	\$1220	\$1153	\$1085
110018	13' x 24" Air Tower	\$1837	\$1745	\$1653	\$1561	\$1470
110019	16.5' x 24" Air Tower	\$2147	\$2040	\$1932	\$1825	\$1718
110020	LED Light Option for 18" Diameter – 1 Light	\$142	\$135	\$128	\$121	\$114
110021	LED Light Option for 24" Diameter – 4 Lights	\$570	\$542	\$513	\$485	\$456 (C)

### PRODUCT SPECIFICATIONS

SIZE	DIMENSIONS	WEIGHT
6.5' x 18"	78"H x 18"Diameter	14 lbs.
10' x 18"	120"H x 18"Diameter	20 lbs.
10' x 24"	120"H x 24"Diameter	25 lbs.
13' x 18"	157"H x 18"Diameter	27 lbs.
13' x 24"	157"H x 24"Diameter	33 lbs.
16.5' x 24"	197"H x 24"Diameter	38 lbs.
LED Light		5 lbs.

# ▶ CONTAINED AIR INFLATABLE ARCHES



**B. DACRON COMPOSITION**  
Ultra resistant material that is perfect for all type of terrains.



**A. OVER PRESSURE VALVE**  
Will guarantee that your Arch fills up to the correct pressure and will release any excess air when optimum pressure is reached.



**C. FAST AIRFLOW ONE-WAY VALVE**  
Easily inflates your arch and keeps the air inside for fast setup.



**D. STAINLESS STEEL BALLAST CONNECTIONS**  
Will allow you to secure your Arch on any terrain.

## SIZES OPTIONS

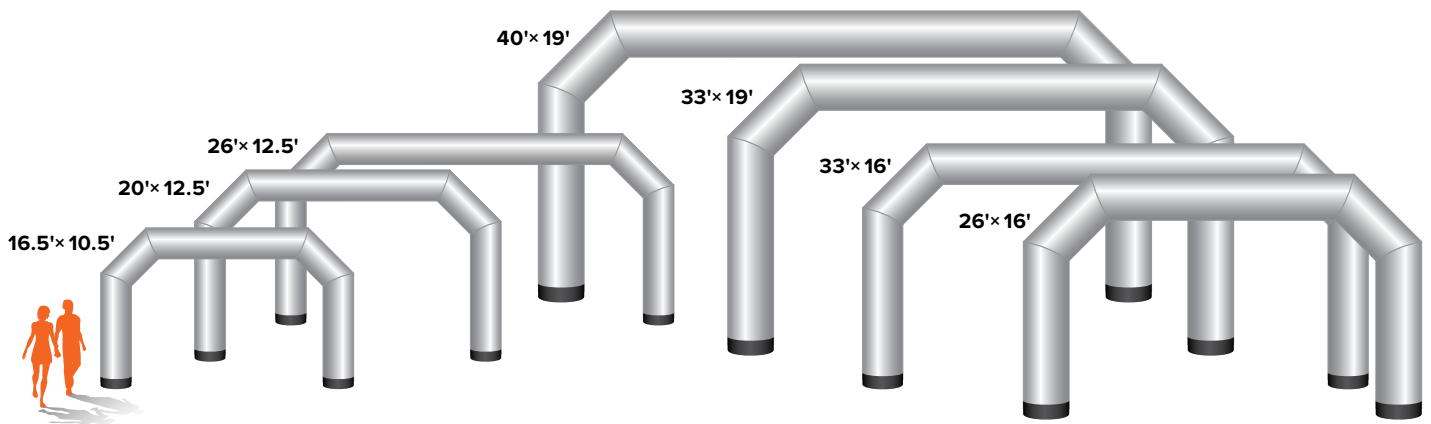

## CONTAINED AIR INFLATABLE ARCH

ITEM #	SIZE	1-4	5-9	10-19	20-49	50+
110022	16.5' x 10.5'	\$2440	\$2318	\$2196	\$2,074	\$1952
110023	20' x 12.5'	\$2934	\$2787	\$2641	\$2494	\$2347
110024	26' x 12.5'	\$3617	\$3436	\$3,255	\$3074	\$2894
110025	26' x 16'	\$4374	\$4155	\$3937	\$3718	\$3499
110026	33' x 16'	\$4813	\$4572	\$4332	\$4091	\$3850
110027	33' x 19'	\$5591	\$5311	\$5032	\$4752	\$4473
110028	40' x 19'	\$6771	\$6432	\$6094	\$5755	\$5417 (C)

## PRODUCT SPECIFICATIONS

SIZE	DIMENSIONS	LEG DIAMETER	WEIGHT
16.5' x 10.5'	197"W x 126"H	24"	50 lbs.
20' x 12.5'	236"W x 150"H	24"	51 lbs.
26' x 12.5'	314"W x 150"H	24"	62 lbs.
26' x 16'	314"W x 189"H	35"	80 lbs.
33' x 16'	393"W x 189"H	32"	100 lbs.
33' x 19'	393"W x 230"H	35"	120 lbs.
40' x 19'	472"W x 230"H	35"	150 lbs.



**B. DACRON COMPOSITION**  
Ultra resistant material that is perfect for all type of terrains.

**A. INTERNAL AIR BLOWER**  
Built in blower to facilitate the inflation of the structure.  
\*Requires 220V/110V electricity during use.

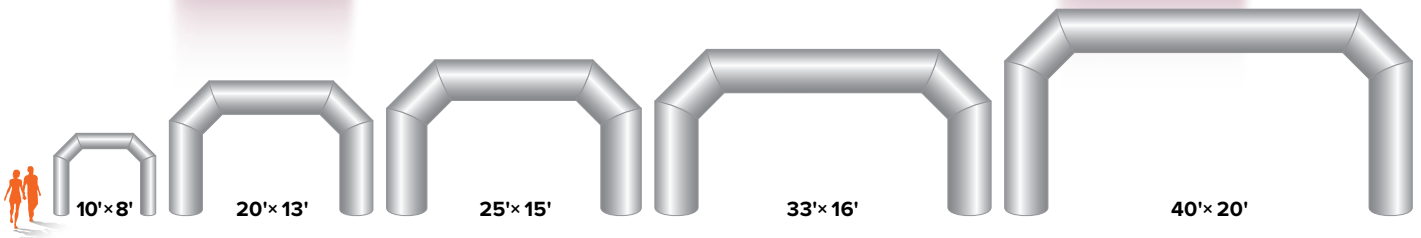

**CONTINUOUS AIR ARCH with INTERNAL BLOWER**

ITEM #	SIZE	1-4	5-9	10-19	20-49	50+
110029	10' x 8'	\$1110	\$1055	\$999	\$944	\$888
110030	20' x 13'	\$1297	\$1232	\$1167	\$1102	\$1038
110031	25' x 15'	\$1942	\$1845	\$1748	\$1651	\$1554
110032	33' x 16'	\$2822	\$2681	\$2540	\$2399	\$2258
110033	40' x 20'	\$3440	\$3268	\$3096	\$2924	\$2752

**PRODUCT SPECIFICATIONS**

SIZE	DIMENSIONS	LEG DIAMETER	WEIGHT
10' x 8'	118"W x 98"H	18"	22 lbs.
20' x 13'	236"W x 157"H	39"	27 lbs.
25' x 15'	311"W x 185"H	47"	50 lbs.
33' x 16'	394"W x 197"H	51"	60 lbs.
40' x 20'	472"W x 236"H	51"	90 lbs.

**CUSTOM INFLATABLE ARCHES & REPLICAS**

**WE CAN CREATE ANYTHING!** ASK US FOR PRICING





# MARQUEE



- ✓ Heavy-duty and easy to set up without the need of tools.
- ✓ Long lasting aluminum that will not rust and is ideal for all weather conditions.



### A. CROSS CABLE TECHNOLOGY

Allows for simple, faster set up. Industrial grade cable provides optimum safety & stability.

**B.**

### B. CONVENIENT POLE SIZES

The longest pole is only 9ft to allow for fast set up and ease of transport.

**C.**

### C. CAST ALUMINUM FOOT PLATE

Allows you to securely anchor the tent to the ground. Comes with lifetime rust warranty.

### ROPES, RATCHETS & HEAVY-DUTY STAKES INCLUDED



### FULL DIGITAL PRINTED VINYL TOP + FRAME

ITEM #	SIZE	1-4	5-9	10-19	20-49	50+
170042	20' x 20'	\$5423	\$5152	\$4881	\$4610	\$4338
170043	20' x 30'	\$8455	\$8032	\$7610	\$7187	\$6764
170044	20' x 40'	\$10345	\$9828	\$9311	\$8793	\$8276

### STOCK COLOR VINYL TOP + FRAME

ITEM #	SIZE	1-4	5-9	10-19	20-49	50+
170045	20' x 20'	\$4244	\$4032	\$3820	\$3607	\$3395
170046	20' x 30'	\$6741	\$6404	\$6067	\$5730	\$5393
170047	20' x 40'	\$7935	\$7538	\$7142	\$6745	\$6348 (C)

### SIZE OPTIONS



### TOP MATERIAL

- ✓ 15 oz Heavy Duty Vinyl
- ✓ Waterproof
- ✓ UV Resistant
- ✓ Flame Retardant

### STOCK COLORS

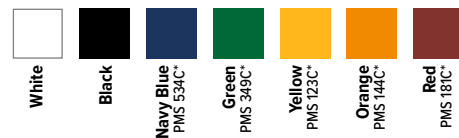

\*PMS colors are for reference only and may vary slightly from actual color.



### PRODUCT SPECIFICATIONS

SIZE	DIMENSIONS	WEIGHT
20' x 20'	240"W x 207"H x 240"D	270 lbs.
20' x 30'	360"W x 207"H x 240"D	389 lbs.
20' x 40'	480"W x 207"H x 240"D	429 lbs.

## WALL OPTIONS

### Wall

#### SINGLE-SIDED FULL DIGITAL PRINT

ITEM #	SIZE	1-4	5-9	10-19	20-49	50+
170011	20'	\$878	\$834	\$790	\$746	\$702
170017	30'	\$1279	\$1215	\$1151	\$1087	\$1023
170023	40'	\$1758	\$1670	\$1582	\$1494	\$1406

#### STOCK COLOR

ITEM #	SIZE	1-4	5-9	10-19	20-49	50+
170014	20'	\$545	\$518	\$491	\$463	\$436
170020	30'	\$786	\$747	\$707	\$668	\$629
170026	40'	\$1090	\$1036	\$981	\$927	\$872



#### PRODUCT SPECIFICATIONS

SIZE	DIMENSIONS	WEIGHT
20'	240"W × 96"H	23 lbs.
30'	360"W × 96"H	32 lbs.
40'	480"W × 96"H	46 lbs.

### Wall with Door

#### SINGLE-SIDED FULL DIGITAL PRINT

ITEM #	SIZE	1-4	5-9	10-19	20-49	50+
170012	20'	\$1,028	\$977	\$925	\$874	\$822
170018	30'	\$1428	\$1357	\$1285	\$1214	\$1142
170024	40'	\$1908	\$1813	\$1717	\$1622	\$1526

#### STOCK COLOR

ITEM #	SIZE	1-4	5-9	10-19	20-49	50+
170015	20'	\$694	\$659	\$625	\$590	\$555
170021	30'	\$936	\$889	\$842	\$796	\$749
170027	40'	\$1239	\$1177	\$1115	\$1053	\$991



#### PRODUCT SPECIFICATIONS

SIZE	DIMENSIONS	WEIGHT
20'	240"W × 96"H	23 lbs.
30'	360"W × 96"H	32 lbs.
40'	480"W × 96"H	46 lbs.

### Wall with Window (Clear Vinyl)

#### SINGLE-SIDED FULL DIGITAL PRINT

ITEM #	SIZE	1-4	5-9	10-19	20-49	50+
170013	20'	\$1028	\$977	\$925	\$874	\$822
170019	30'	\$1428	\$1357	\$1285	\$1214	\$1142
170025	40'	\$1908	\$1813	\$1717	\$1622	\$1526

#### STOCK COLOR

ITEM #	SIZE	1-4	5-9	10-19	20-49	50+
170016	20'	\$694	\$659	\$625	\$590	\$555
170022	30'	\$936	\$889	\$842	\$796	\$749
170028	40'	\$1239	\$1177	\$1115	\$1053	\$991



#### PRODUCT SPECIFICATIONS

SIZE	DIMENSIONS	WEIGHT
20'	240"W × 96"H	23 lbs.
30'	360"W × 96"H	32 lbs.
40'	480"W × 96"H	46 lbs.

SKY TENT

**Sky Tent**™



**A. CRANK SHAFT TECHNOLOGY**

The crank shaft technology makes the set up of your star canopy easier than ever. Simply slide the pole underneath the canopy and turn the crank to adjust the pole's height at your own pace.



**B. ANODIZED ALUMINUM POLE**  
Rust-free, light-weight, and well constructed to last event after event.



**C. HEAVY DUTY STAKES KIT & STAKE PULLER**  
These ingenious complimentary accessories will help you remove the stakes from the ground.



**D. ANTI-SLIDE POLE BASE**  
This smart design will properly secure your star tent to the ground and prevent the pole from shuffling on the floor.



HEAVY-DUTY STAKES & CARRYING BAG INCLUDED

**FULL DYE-SUB PRINTED POLYESTER TOP + FRAME**

ITEM #	SIZE	1-4	5-9	10-19	20-49	50+
210041	20'	\$3148	\$2991	\$2833	\$2676	\$2518
210042	26'	\$3907	\$3712	\$3516	\$3321	\$3126
210043	40'	\$5765	\$5477	\$5189	\$4900	\$4612
210044	52'	\$7903	\$7508	\$7113	\$6718	\$6322 (C)

**STOCK COLOR POLYESTER TOP + FRAME**

ITEM #	SIZE	1-4	5-9	10-19	20-49	50+
210047	20'	\$2454	\$2331	\$2209	\$2086	\$1963
210048	26'	\$2691	\$2556	\$2422	\$2287	\$2153
210049	40'	\$3349	\$3182	\$3014	\$2847	\$2679
210050	52'	\$4077	\$3873	\$3669	\$3465	\$3262 (C)

**SIZE OPTIONS**



**PRODUCT SPECIFICATIONS**

SIZE	DIMENSIONS	WEIGHT
20'	240"Diameter x 156"H	102 lbs.
26'	312"Diameter x 204"H	117 lbs.
40'	480"Diameter x 240"H	141 lbs.
52'	624"Diameter x 240"H	163 lbs.

**TOP MATERIAL**

- ✓ 600 Denier Polyester
- ✓ Water Resistant
- ✓ UV Resistant
- ✓ Flame Retardant

**STOCK COLORS**

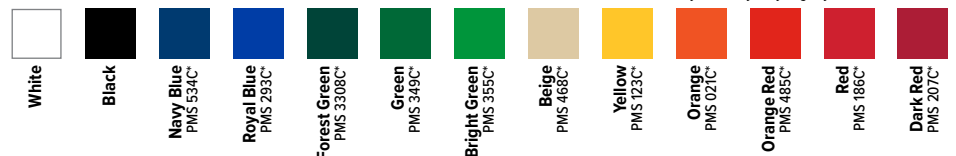

\*PMS colors are for reference only and may vary slightly from actual color.

## WALL OPTIONS

### Wall

#### SINGLE-SIDED FULL DYE-SUB PRINT

ITEM #	SIZE	1-4	5-9	10-19	20-49	50+
210017	10' Wall for 20' Tent	\$361	\$343	\$325	\$307	\$289
210021	13' Wall for 26' Tent	\$476	\$452	\$428	\$405	\$381
210025	20' Wall for 40' or 54' × 34' Tent	\$698	\$663	\$628	\$593	\$558
210029	26' Wall for 52' or 72' × 45' Tent	\$906	\$861	\$815	\$770	\$725

#### STOCK COLOR

ITEM #	SIZE	1-4	5-9	10-19	20-49	50+
210019	10' Wall for 20' Tent	\$196	\$186	\$176	\$167	\$157
210023	13' Wall for 26' Tent	\$244	\$232	\$220	\$207	\$195
210027	20' Wall for 40' or 54' × 34' Tent	\$346	\$329	\$311	\$294	\$277
210031	26' Wall for 52' or 72' × 45' Tent	\$458	\$435	\$412	\$389	\$366 (C)



#### PRODUCT SPECIFICATIONS

SIZE	DIMENSIONS	WEIGHT
10'	114"W × 92"H	10 lbs.
13'	154"W × 104"H	13 lbs.
20'	234"W × 113"H	18 lbs.
26'	313"W × 130"H	22 lbs.

### Wall with Window (Clear Vinyl)

#### SINGLE-SIDED FULL DYE-SUB PRINT

ITEM #	SIZE	1-4	5-9	10-19	20-49	50+
210018	10' Wall for 20' Tent	\$468	\$445	\$421	\$398	\$374
210022	13' Wall for 26' Tent	\$583	\$554	\$525	\$496	\$466
210026	20' Wall for 40' or 54' × 34' Tent	\$805	\$765	\$725	\$684	\$644
210030	26' Wall for 52' or 72' × 45' Tent	\$1013	\$962	\$912	\$861	\$810

#### STOCK COLOR

ITEM #	SIZE	1-4	5-9	10-19	20-49	50+
210020	10' Wall for 20' Tent	\$303	\$288	\$273	\$258	\$242
210024	13' Wall for 26' Tent	\$351	\$333	\$316	\$298	\$281
210028	20' Wall for 40' or 54' × 34' Tent	\$453	\$430	\$408	\$385	\$362
210032	26' Wall for 52' or 72' × 45' Tent	\$565	\$537	\$509	\$480	\$452 (C)



#### PRODUCT SPECIFICATIONS

SIZE	DIMENSIONS	WEIGHT
10'	114"W × 92"H	10 lbs.
13'	154"W × 104"H	13 lbs.
20'	234"W × 113"H	18 lbs.
26'	313"W × 130"H	22 lbs.





▶ TABLE COVERS

**STRETCH TABLE COVER**

**FULL DIGITAL PRINT**

ITEM #	SIZE	1-4	5-9	10-19	20-49	50+
220025	4'	\$225	\$214	\$203	\$191	\$180
220026	6'	\$259	\$246	\$233	\$220	\$207
220027	8'	\$312	\$296	\$281	\$265	\$250

**FULL DIGITAL PRINT + BACK ZIPPER**

ITEM #	SIZE	1-4	5-9	10-19	20-49	50+
220051	4'	\$270	\$257	\$243	\$230	\$216
220052	6'	\$304	\$289	\$274	\$258	\$243
220053	8'	\$357	\$339	\$321	\$303	\$286 (C)

**PRODUCT SPECIFICATIONS**

SIZE	DIMENSIONS	WEIGHT
4'	48"W x 29"H x 24"D	2 lbs.
6'	72"W x 29"H x 30"D	3 lbs.
8'	96"W x 29"H x 30"D	3 lbs.



**BACK ZIPPER OPTION**



**FITTED TABLE COVER**

**FULL DIGITAL PRINT**

ITEM #	SIZE	1-4	5-9	10-19	20-49	50+
220008	4'	\$225	\$214	\$203	\$191	\$180
220012	6'	\$259	\$246	\$233	\$220	\$207
220016	8'	\$312	\$296	\$281	\$265	\$250

**STOCK COLOR + PRINTED FRONT PANEL ONLY**

ITEM #	SIZE	1-4	5-9	10-19	20-49	50+
220009	4'	\$195	\$185	\$176	\$166	\$156
220013	6'	\$228	\$217	\$205	\$194	\$182
220017	8'	\$275	\$261	\$248	\$234	\$220

**FULL DIGITAL PRINT + BACK ZIPPER**

ITEM #	SIZE	1-4	5-9	10-19	20-49	50+
220011	4'	\$270	\$257	\$243	\$230	\$216
220015	6'	\$304	\$289	\$274	\$258	\$243
220019	8'	\$357	\$339	\$321	\$303	\$286

**STOCK COLOR + PRINTED FRONT PANEL ONLY + BACK ZIPPER**

ITEM #	SIZE	1-4	5-9	10-19	20-49	50+
220010	4'	\$240	\$228	\$216	\$204	\$192
220014	6'	\$273	\$259	\$246	\$232	\$218
220018	8'	\$320	\$304	\$288	\$272	\$256 (C)



**BACK ZIPPER OPTION**



**PRODUCT SPECIFICATIONS**

SIZE	DIMENSIONS	WEIGHT
4'	48"W x 29"H x 24"D	2 lbs.
6'	72"W x 29"H x 30"D	3 lbs.
8'	96"W x 29"H x 30"D	4 lbs.

**PRINTING OPTIONS**



**Fully Printed**



**Front Panel Only**

**STOCK COLORS**



*\*PMS colors are for reference only and may vary slightly from actual color.*

## CROSS-STRETCH TABLE COVER

### FULL DIGITAL PRINT

ITEM #	SIZE	1-4	5-9	10-19	20-49	50+
220003	4'	\$276	\$262	\$248	\$235	\$221
220004	6'	\$310	\$295	\$279	\$264	\$248
220005	8'	\$375	\$356	\$338	\$319	\$300 (C)

### PRODUCT SPECIFICATIONS

SIZE	DIMENSIONS	WEIGHT
4'	48"W x 29"H x 24"D	3 lbs.
6'	72"W x 29"H x 30"D	4 lbs.
8'	96"W x 29"H x 30"D	5 lbs.



## TABLE TOP COVER

### FULL DIGITAL PRINT

ITEM #	SIZE	1-4	5-9	10-19	20-49	50+
220048	4'	\$148	\$141	\$133	\$126	\$118
220049	6'	\$171	\$162	\$154	\$145	\$137
220050	8'	\$196	\$186	\$176	\$167	\$157 (C)

### PRODUCT SPECIFICATIONS

SIZE	DIMENSIONS	WEIGHT
4'	48"L x 24"W	1 lbs.
6'	72"L x 30"W	1 lbs.
8'	96"L x 30"W	1 lbs.



## NON-FITTED TABLE COVER

### FULL DIGITAL PRINT

ITEM #	SIZE	1-4	5-9	10-19	20-49	50+
220021	4'	\$268	\$255	\$241	\$228	\$214
220022	6'	\$294	\$279	\$265	\$250	\$235
220023	8'	\$353	\$335	\$318	\$300	\$282

### PRODUCT SPECIFICATIONS

SIZE	DIMENSIONS	WEIGHT
4'	48"W x 29"H x 24"D	2 lbs.
6'	72"W x 29"H x 30"D	3 lbs.
8'	96"W x 29"H x 30"D	4 lbs.



## TABLE RUNNER

### FULL DIGITAL PRINT

ITEM #	SIZE	1-4	5-9	10-19	20-49	50+
220031	80" x 24"	\$114	\$108	\$103	\$97	\$91
220032	80" x 36"	\$123	\$117	\$111	\$105	\$98
220033	98" x 16"	\$93	\$88	\$84	\$79	\$74
220029	122" x 16"	\$116	\$110	\$104	\$99	\$93
220030	146" x 16"	\$139	\$132	\$125	\$118	\$111 (C)

\*Table cover not included



# PROMO FLAG™

**A. FIBERGLASS POLES**

We have selected to use premium fiberglass poles that are much more flexible and wind resistant than the aluminum poles found in the market.

**B. ADJUSTABLE STRAP**

Use this adjustable strap to secure it onto the leg of the flagpole.



**C. PLASTIC END CAP**

For the pole to easily slip into the sheath when setting up the flag.

**D. STITCHING**

Our meticulous stitching technique gives your flag a seamless sewing presentation.

**E. POLE SLEEVE**

Use to safely secure your custom printed flag straps onto the pole.

**F. TENSION STRAP ON FLAG**

All of our flags come with a tension strap that is convenient for attaching your flag to your tent with a zip tie.

**G. FLAG CARRYING BAG INCLUDED**

Easily store and carry your custom flag in this convenient carrying case.

**ACCESSORIES**

ITEM #	ITEM NAME	1-4	5-9	10-19	20-49	50+
150006	Ground Spike & Ball Bearing	\$32	\$30	\$29	\$27	\$26
150010	Heavy Duty X-Base	\$64	\$61	\$58	\$54	\$51
150009	Water Bag	\$16	\$15	\$14	\$14	\$13
150004	Ground Screw	\$51	\$48	\$46	\$43	\$41
150005	Metal Base	\$128	\$122	\$115	\$109	\$102
150007	Flag Holder for V3/V4 canopy	\$51	\$48	\$46	\$43	\$41
150008	Flag Holder for V5 canopy	\$51	\$48	\$46	\$43	\$41 (C)



**GROUND SPIKE & BALL BEARING**  
Secures your flag to the ground while the ball bearing stabilizes against any wind.



**HEAVY-DUTY X-BASE**  
This ground stand is perfect to secure your flag on asphalt or on any flat surface.



**WATER BAG**  
This water bag provides up to 25 lbs of additional support for the X-base.



**GROUND SCREW**  
This ground screw is ideal to secure your flag on the beach or in snow.



**METAL BASE**  
This heavy-duty 22 lbs weight provides maximum support to secure your flag.



**FLAG HOLDER**  
This flag holder attaches to the canopy's leg.

**PRINTING OPTIONS**



**SINGLE-SIDED**  
Print Through



**DOUBLE-SIDED**  
Dual Side Printed





## Teardrop Flag

### SINGLE-SIDED FULL PRINT + POLE

ITEM #	SIZE	1-4	5-9	10-19	20-49	50+
150042	7'	\$187	\$178	\$168	\$159	\$150
150043	11'	\$214	\$203	\$193	\$182	\$171
150044	15'	\$254	\$241	\$229	\$216	\$203

### DOUBLE-SIDED FULL PRINT + POLE

ITEM #	SIZE	1-4	5-9	10-19	20-49	50+
150045	7'	\$216	\$205	\$194	\$184	\$173
150046	11'	\$255	\$242	\$230	\$217	\$204
150047	15'	\$316	\$300	\$284	\$269	\$253

### PRODUCT SPECIFICATIONS

SIZE	DIMENSIONS	WEIGHT
7'	32"W x 88"H	3 lbs.
11'	39"W x 132"H	4 lbs.
15'	48"W x 182"H	4 lbs.

\*Weights for Single-Sided & Stock Items

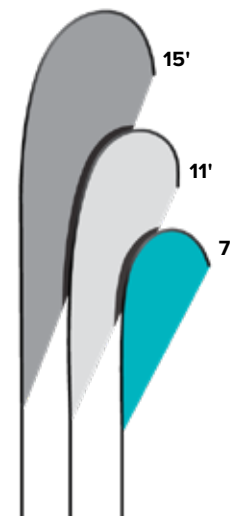

## Sunblade Flag

### SINGLE-SIDED FULL PRINT + POLE

ITEM #	SIZE	1-4	5-9	10-19	20-49	50+
150048	8'	\$187	\$178	\$168	\$159	\$150
150049	13'	\$214	\$203	\$193	\$182	\$171
150050	17'	\$254	\$241	\$229	\$216	\$203

### DOUBLE-SIDED FULL PRINT + POLE

ITEM #	SIZE	1-4	5-9	10-19	20-49	50+
150051	8'	\$216	\$205	\$194	\$184	\$173
150052	13'	\$255	\$242	\$230	\$217	\$204
150053	17'	\$316	\$300	\$284	\$269	\$253

### PRODUCT SPECIFICATIONS

SIZE	DIMENSIONS	WEIGHT
8'	26"W x 99"H	3 lbs.
13'	30"W x 155"H	4 lbs.
17'	31"W x 206"H	4 lbs.

\*Weights for Single-Sided & Stock Items

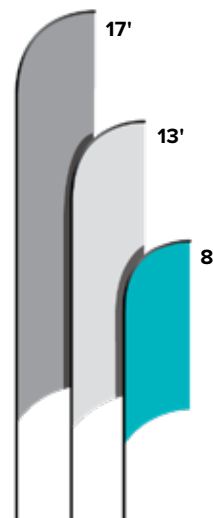

## Banner Flag

### SINGLE-SIDED FULL PRINT + POLE

ITEM #	SIZE	1-4	5-9	10-19	20-49	50+
150054	7'	\$187	\$178	\$168	\$159	\$150
150055	10'	\$214	\$203	\$193	\$182	\$171
150056	13'	\$254	\$241	\$229	\$216	\$203

### DOUBLE-SIDED FULL PRINT + POLE

ITEM #	SIZE	1-4	5-9	10-19	20-49	50+
150057	7'	\$216	\$205	\$194	\$184	\$173
150058	10'	\$255	\$242	\$230	\$217	\$204
150059	13'	\$316	\$300	\$284	\$269	\$253

### PRODUCT SPECIFICATIONS

SIZE	DIMENSIONS	WEIGHT
7'	30"W x 82"H	3 lbs.
10'	30"W x 114"H	3 lbs.
13'	30"W x 157"H	4 lbs.

\*Weights for Single-Sided & Stock Items

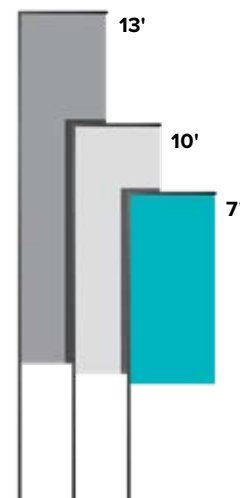

▶ MARKET UMBRELLAS



# ACAPULCO COMMERCIAL GRADE MARKET UMBRELLAS

Our commercial grade market umbrellas are perfect for all types of businesses and events. Their durable elements and composition make them ideal for providing the right shade and protection from the sun. From restaurants and cafes, to outdoor lounge areas, these umbrellas provide a perfect presentation of your brand while enjoying a comfortable shaded setting.

### FRAMES AVAILABLE

#### HARDWOOD



**Strongest wood frame in the industry**  
38mm hardwood 2-piece frame  
with brass screw connections

#### STEEL

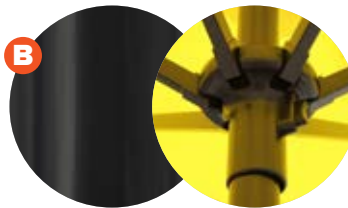

38mm heavy-duty steel with  
an easy opening system

#### WOOD LOOK



38mm heavy duty steel with wood look finishing  
3-positions tilt\* with an adjustable height pole

*\*only available for wood look frame option*

#### 5.5'x5.5' SQUARE / 4 PANELS - Fabric Top + Wood Pole

FABRIC	PRINT	SETUP FEE	6-15	16-30	31-50	50+
Polyester – Standard UV Lasting	Fully Printed	FREE	\$225	\$213	\$202	\$192
Polyester – Long UV Lasting	Fully Printed	FREE	\$427	\$403	\$382	\$363
Acrylic Marine Grade – Extended UV Lasting	Printed Cost Below	\$200 / Color	\$443	\$418	\$397	\$377
<b>SCREEN PRINTING (Optional)</b>	<b>1 Color Logo</b>	<b>2 Color Logo</b>	<b>3 Color Logo</b>	<b>4 Color Logo</b>	<b>Full Color Logo</b>	
Setup Fee: \$200 / Color	\$19 / Panel	\$29 / Panel	\$37 / Panel	\$46 / Panel	\$63 / Panel	



**PRODUCT SPECIFICATIONS**  
SIZE WEIGHT HEIGHT  
5.5'x5.5' 10 lbs. 96"

#### 7' ROUND / 6 PANELS - Fabric Top + Wood, Steel, or Wood Look Pole

FABRIC	PRINT	SETUP FEE	6-15	16-30	31-50	50+
Polyester – Standard UV Lasting	Fully Printed	FREE	\$225	\$213	\$202	\$192
Polyester – Long UV Lasting	Fully Printed	FREE	\$427	\$403	\$382	\$363
Acrylic Marine Grade – Extended UV Lasting	Printed Cost Below	\$200 / Color	\$443	\$418	\$397	\$377
<b>SCREEN PRINTING (Optional)</b>	<b>1 Color Logo</b>	<b>2 Color Logo</b>	<b>3 Color Logo</b>	<b>4 Color Logo</b>	<b>Full Color Logo</b>	
Setup Fee: \$200 / Color	\$19 / Panel	\$29 / Panel	\$37 / Panel	\$46 / Panel	\$63 / Panel	



**PRODUCT SPECIFICATIONS**  
SIZE WEIGHT HEIGHT  
7' D 13 lbs. 94"

#### 9' ROUND / 8 PANELS - Fabric Top + Wood, Steel, or Wood Look Pole

FABRIC	PRINT	SETUP FEE	6-15	16-30	31-50	50+
Polyester – Standard UV Lasting	Fully Printed	FREE	\$292	\$277	\$262	\$248
Polyester – Long UV Lasting	Fully Printed	FREE	\$553	\$522	\$495	\$470
Acrylic Marine Grade – Extended UV Lasting	Printed Cost Below	\$200 / Color	\$657	\$620	\$588	\$558
<b>SCREEN PRINTING (Optional)</b>	<b>1 Color Logo</b>	<b>2 Color Logo</b>	<b>3 Color Logo</b>	<b>4 Color Logo</b>	<b>Full Color Logo</b>	
Setup Fee: \$200 / Color	\$19 / Panel	\$29 / Panel	\$37 / Panel	\$46 / Panel	\$63 / Panel	



**PRODUCT SPECIFICATIONS**  
SIZE WEIGHT HEIGHT  
9' D 14 lbs. 96"

(C)



**CASABLANCA**  
CASABLANCA  
RESORT GRADE  
UMBRELLAS



A high-end elegant market umbrella for a remarkable presentation of your brand. Made from high-quality materials and commercial grade components, our **Casablanca Umbrellas** are resilient and provide a superb presentation. We use the best materials in the market in combination with our high resolution printing abilities to bring you the best umbrellas.



**A CRANK SYSTEM**  
*Convenient crank system to easily setup your umbrella.*



**B TELESCOPING TILT POLE**  
*Easily adjust your pole to the desired direction.*



**C 1/2" THICK FIBERGLASS RIBS**  
*provide maximum flexibility.*



**D 4 LAYER POCKETS**  
*reinforced with additional pockets to prevent tearing.*



**E 1.5" THICK HIGH GRADE ALUMINUM POLE**  
*Rust Free guarantee.*

**7.5' ROUND / 6 PANELS - Fabric Top + Pole**

FABRIC	PRINT	SETUP FEE	6-15	16-30	31-50	50+
Polyester – Standard UV Lasting	Fully Printed	FREE	\$325	\$307	\$292	\$277
Polyester – Long UV Lasting	Fully Printed	FREE	\$570	\$538	\$510	\$485
Acrylic Marine Grade – Extended UV Lasting	Printed Cost Below	\$200 / Color	\$588	\$555	\$527	\$500
<b>SCREEN PRINTING (Optional)</b>	<b>1 Color Logo</b>	<b>2 Color Logo</b>	<b>3 Color Logo</b>	<b>4 Color Logo</b>	<b>Full Color Logo</b>	
Setup Fee: \$200 / Color	\$19 / Panel	\$29 / Panel	\$37 / Panel	\$46 / Panel	\$63 / Panel	



**PRODUCT SPECIFICATIONS**  
SIZE WEIGHT HEIGHT  
7.5' D 8 lbs. 95"

**9' ROUND / 8 PANELS - Fabric Top + Pole**

FABRIC	PRINT	SETUP FEE	6-15	16-30	31-50	50+
Polyester – Standard UV Lasting	Fully Printed	FREE	\$397	\$373	\$355	\$337
Polyester – Long UV Lasting	Fully Printed	FREE	\$697	\$657	\$623	\$592
Acrylic Marine Grade – Extended UV Lasting	Printed Cost Below	\$200 / Color	\$807	\$762	\$722	\$685
<b>SCREEN PRINTING (Optional)</b>	<b>1 Color Logo</b>	<b>2 Color Logo</b>	<b>3 Color Logo</b>	<b>4 Color Logo</b>	<b>Full Color Logo</b>	
Setup Fee: \$200 / Color	\$19 / Panel	\$29 / Panel	\$37 / Panel	\$46 / Panel	\$63 / Panel	



**PRODUCT SPECIFICATIONS**  
SIZE WEIGHT HEIGHT  
9' D 10 lbs. 98"

**6.5'x6.5' SQUARE / 4 PANELS - Fabric Top + Pole**

FABRIC	PRINT	SETUP FEE	6-15	16-30	31-50	50+
Polyester – Standard UV Lasting	Fully Printed	FREE	\$330	\$312	\$295	\$280
Polyester – Long UV Lasting	Fully Printed	FREE	\$655	\$618	\$587	\$557
Acrylic Marine Grade – Extended UV Lasting	Printed Cost Below	\$200 / Color	\$785	\$740	\$702	\$667
<b>SCREEN PRINTING (Optional)</b>	<b>1 Color Logo</b>	<b>2 Color Logo</b>	<b>3 Color Logo</b>	<b>4 Color Logo</b>	<b>Full Color Logo</b>	
Setup Fee: \$200 / Color	\$19 / Panel	\$29 / Panel	\$37 / Panel	\$46 / Panel	\$63 / Panel	

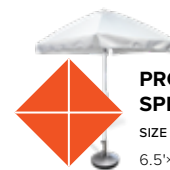

**PRODUCT SPECIFICATIONS**  
SIZE WEIGHT HEIGHT  
6.5'x6.5' 7 lbs. 98"





## A MODERN CLASSIC PATIO UMBRELLA

A modern presentation with exceptional branding solutions. Our **Montecarlo Umbrellas** offer a mix of quality commercial grade materials with the best printing techniques in the market for a lasting presentation in the outdoors.



**KNOB SYSTEM**  
*for faster height adjustment.*



**1.5" THICK HIGH GRADE ALUMINUM POLES** *strong enough for all outdoor environments.*



**TELESCOPING TILT POLE**  
*Easily adjust your pole to the desired direction.*



**PUSH BUTTON**  
*for perfect tension.*



**SOLID FIBERGLASS RIBS** *provide maximum flexibility.*

### 7.5' ROUND / 6 PANELS - Fabric Top + Pole

FABRIC	PRINT	SETUP FEE	6-15	16-30	31-50	50+
Polyester – Standard UV Lasting	Fully Printed	FREE	\$288	\$272	\$258	\$245
Polyester – Long UV Lasting	Fully Printed	FREE	\$480	\$453	\$430	\$408
Acrylic Marine Grade – Extended UV Lasting	Printed Cost Below	\$200 / Color	\$497	\$468	\$443	\$422

SCREEN PRINTING (Optional)	1 Color Logo	2 Color Logo	3 Color Logo	4 Color Logo	Full Color Logo
Setup Fee: \$200 / Color	\$19 / Panel	\$29 / Panel	\$37 / Panel	\$46 / Panel	\$63 / Panel

(C)



### PRODUCT SPECIFICATIONS

SIZE	WEIGHT	HEIGHT
7.5' D	8 lbs	93"



## A FUN BEACH UMBRELLA

An entry level, branded umbrella for fun outdoor events. The **Copacabana** is an ideal on the go umbrella that is easy to transport and set up. Featuring a 300 Denier branded top that is lightweight, water resistant, and UV resistant making it ideal for printing any logo or design.

*\*Copacabana umbrellas come with valances only*



### TELESCOPING TILT POLE

*Easily adjust your pole to the desired direction.*



### COMMERCIAL GRADE POLES

*Powder coated steel for lasting durability.*



### LOCKING SYSTEM

*Easily locks in place without effort.*



### DUAL-PURPOSE END

*Tapered for easy insertion into the ground or any base.*



*Lightweight yet strong FLEXIBLE RIBS.*

### 6' ROUND / 8 PANELS - Fabric Top + Pole

FABRIC	PRINT	SETUP FEE	6-15	16-30	31-50	50+
Polyester – Standard UV Lasting	Fully Printed	FREE	\$175	\$165	\$157	\$148 (C)



**PRODUCT SPECIFICATIONS**

SIZE	WEIGHT	Height
6' D	7 lbs.	85"

▶ CUSTOM OPTIONS

9 Oz. Marine Grade Acrylic Fabric \*\*\*

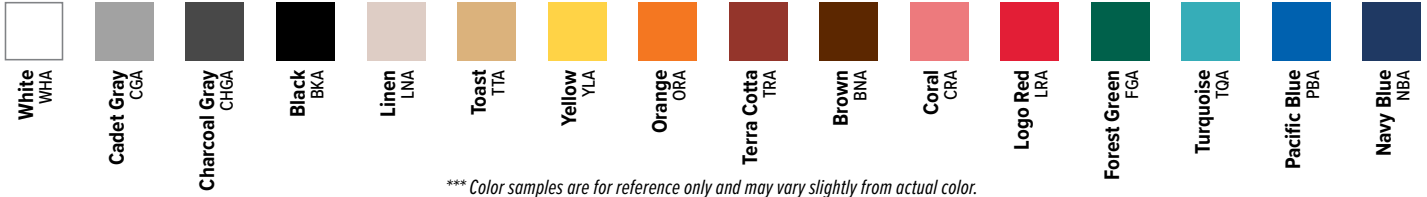

\*\*\* Color samples are for reference only and may vary slightly from actual color.

▶ ACCESSORIES

50 lbs CONCRETE BASE



Add support to your umbrella with this 50 lbs concrete-filled weight made from UV stabilized polymer to resist cracking and fading.

DESCRIPTION	1-9	10-19	20-49	50+
50 lbs Concrete Base	\$85	\$80	\$75	\$72 (C)

80 lbs CONCRETE BASE



This freestanding umbrella base is prefilled with concrete to provide 80 lbs support to any of our umbrellas.

DESCRIPTION	1-9	10-19	20-49	50+
80 lbs Concrete Base	\$132	\$123	\$118	\$112 (C)

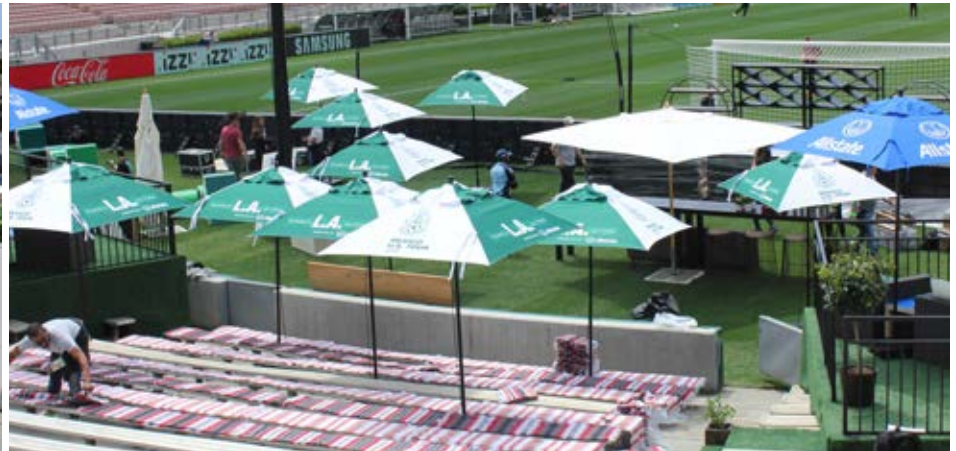





**A. 3 LEVELS OF SHELVING**

Manufactured with durable blow-mold shelves for commercial use.

**B. CUSTOM WRAP**

Print any design on this interchangeable 600 Denier polyester wrap.

**C. STEEL FRAME**

Sturdy and durable for long-lasting use.

**D. IN-SHELF COOLER/STORAGE**

Keeps your beverages and ice cool during your events.

**E. 6' CUSTOM UMBRELLA**

Print a consistent design to match your wrap for an ideal presentation.

**F. 4 FOLDABLE STOOLS**

Custom printed seat covers.

**FREE BAR ROLLER BAG & STOOL CARRYING BAG INCLUDED**

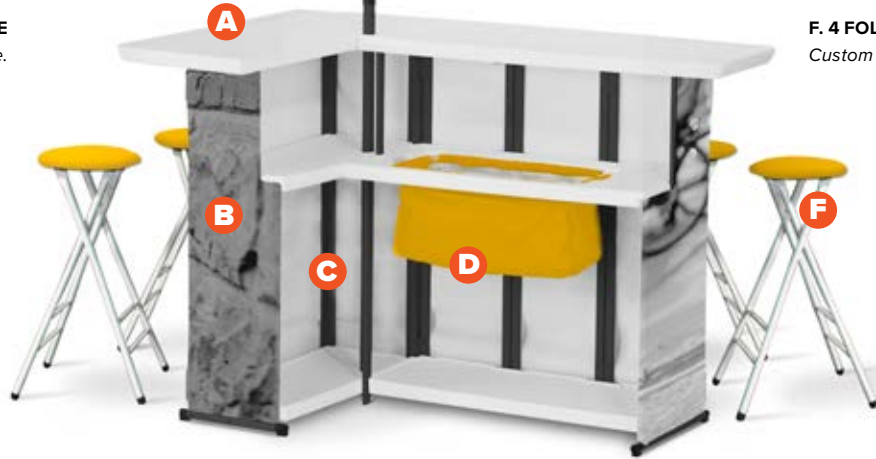

TRAVEL

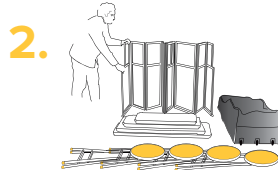

ASSEMBLE



SET UP



ENJOY

**FULL BAR SET (FULL DYE-SUB PRINT)**

ITEM #	INCLUDES	1-4	5-9	10-19	20-49	50+
130009	Counter, Umbrella, & 4 Stools	\$1566	\$1488	\$1409	\$1331	\$1253

**BAR + UMBRELLA (FULL DYE-SUB PRINT)**

ITEM #	INCLUDES	1-4	5-9	10-19	20-49	50+
130008	Counter & Umbrella	\$1193	\$1133	\$1074	\$1014	\$954

**STOOLS (FULL DYE-SUB PRINT)**

ITEM #	INCLUDES	1-4	5-9	10-19	20-49	50+
130010	4 Stools	\$373	\$354	\$336	\$317	\$298 (C)

**PRODUCT SPECIFICATIONS**

SIZE	DIMENSIONS	WEIGHT
Bar Counter	41"W × 63"L × 35"H	70 lbs.
Umbrella	70"W × 95"H × 70"D	11 lbs.
(4) Stools	14"Diameter × 30"H	30 lbs.



▶ SIGNS & BANNERS

**CUSTOM BANNERS**

**Polyester/Vinyl/Mesh Vinyl**

**PRICE PER SQ. FT (FULL DIGITAL PRINT)**

0-100	101-500	501-1000	1001+
\$5	\$4.75	\$4.50	\$4.25

*\*Hardware not included*

**Finish Options**

**GROMMETS**

PRICE PER GROMMET  
\$1.67

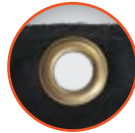

GROMMETS

**POLE SLEEVE**

PRICE PER LINEAR FT.  
\$1.67



POLE SLEEVE

**HOOK & LOOP STRAPS**

PRICE PER LINEAR FT.  
\$1.67 (C)

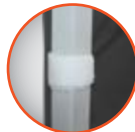

HOOK & LOOP STRAPS



**RETRACTABLE BANNER**

**FULL DIGITAL PRINT + HARDWARE**

ITEM #	1-4	5-9	10-19	20-49	50+
120009	\$244	\$232	\$220	\$207	\$195 (C)

**PRODUCT SPECIFICATIONS**

DIMENSIONS	WEIGHT
33.5"W x 80"H	9 lbs.

- ✓ Tradeshow Ready
- ✓ Vinyl Fabric
- ✓ Hardware Included
- ✓ Carrying Bag Included



## 10' x 8' BACKDROP



### FULL DIGITAL PRINTED POLYESTER

ITEM #	1-4	5-9	10-19	20-49	50+	(C)
120002	\$337	\$320	\$303	\$286	\$270	

\*Hardware and drapes not included

### Choice of One Finish Option Included



GROMMETS



POLE SLEEVE

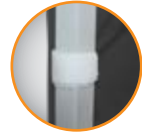

HOOK & LOOP STRAPS

### PRODUCT SPECIFICATIONS

SIZE	DIMENSIONS	WEIGHT
10' x 8'	116"W x 96"H	9 lbs.

## EXPANDABLE HARDWARE

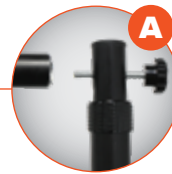
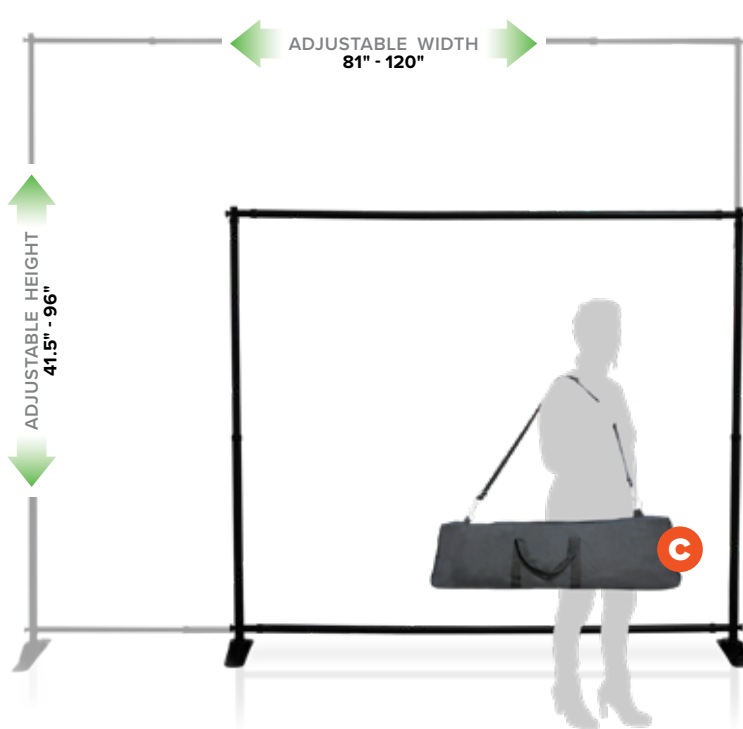

### A. SCREW ATTACHMENTS

Easily attach to secure the poles in place.

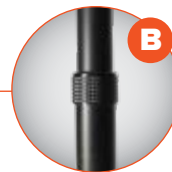

### B. ADJUSTABLE TELESCOPIC POLES

Can be used for different banner sizes.

### C. FREE CARRYING BAG INCLUDED

Fits all hardware for easy transport.

### BACKDROP FRAME

ITEM #	1-4	5-9	10-19	20-49	50+	(C)
120003	\$324	\$308	\$292	\$275	\$259	

### PRODUCT SPECIFICATIONS

DIMENSIONS	WEIGHT
81"-120"W x 41.5"-96"H	17 lbs.

POP-UP BANNERS



Horizontal Banner

FULL DIGITAL PRINT + FRAME

ITEM #	SIZE	1-4	5-9	10-19	20-49	50+
190003	63" × 26"	\$265	\$252	\$239	\$225	\$212
190002	79" × 40"	\$276	\$262	\$248	\$235	\$221 (C)

PRODUCT SPECIFICATIONS

DIMENSIONS	WEIGHT
63"W × 26"H	4 lbs.
79"W × 40"H	7 lbs.

Vertical Banner

FULL DIGITAL PRINT + FRAME

ITEM #	SIZE	1-4	5-9	10-19	20-49	50+
190006	35" × 43"	\$300	\$285	\$270	\$255	\$240
190005	41" × 49"	\$318	\$302	\$286	\$270	\$254 (C)

PRODUCT SPECIFICATIONS

DIMENSIONS	WEIGHT
35"W × 43"H	5 lbs.
41"W × 49"H	6 lbs.

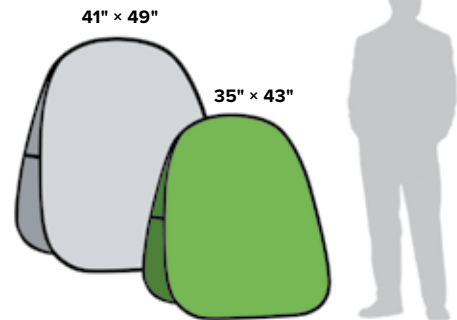
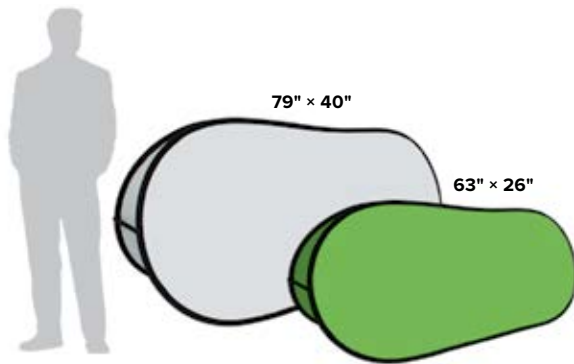

EASY TO TRANSPORT

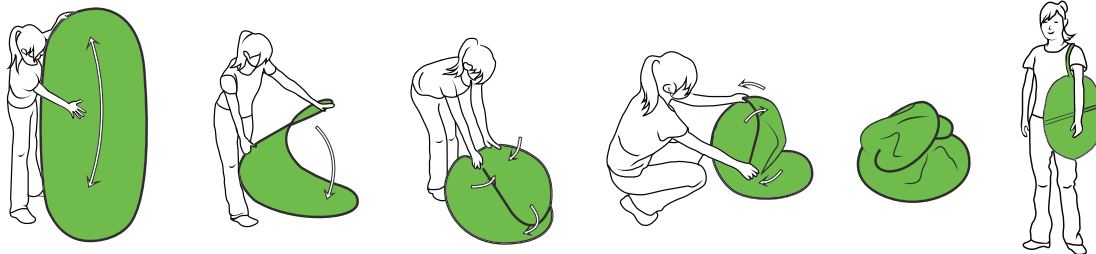

FREE CARRYING BAG & STAKE KIT INCLUDED





**BARRICADE COVERS**



SIGNS & BANNERS

**Polyester Cover**

**FULL DIGITAL PRINT**

ITEM #	SIZE	1-4	5-9	10-19	20-49	50+
120004	3' x 7'	\$225	\$214	\$203	\$191	\$180
120004	3' x 8'	\$257	\$244	\$231	\$218	\$206
120004	3' x 10'	\$321	\$305	\$289	\$273	\$257

**Mesh Cover**

**FULL DIGITAL PRINT**

ITEM #	SIZE	1-4	5-9	10-19	20-49	50+
120004	3' x 7'	\$225	\$214	\$203	\$191	\$180
120004	3' x 8'	\$257	\$244	\$231	\$218	\$206
120004	3' x 10'	\$321	\$305	\$289	\$273	\$257

**Stretch Cover**

**FULL DIGITAL PRINT**

ITEM #	SIZE	1-4	5-9	10-19	20-49	50+
120004	3' x 7'	\$225	\$214	\$203	\$191	\$180
120004	3' x 8'	\$257	\$244	\$231	\$218	\$206
120004	3' x 10'	\$321	\$305	\$289	\$273	\$257 (C)

\*Hardware not included

Choice of One Finish Option Included



GROMMETS

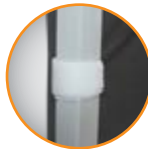

HOOK & LOOP STRAPS

▶ POP-UP WALLS

POP-UP WALLS

**A. OVERSIZED HOOK & LOOP FASTENERS**

*Allows for easy attachment of the fabric.*

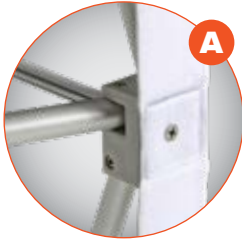

**C. ANODIZED ALUMINUM FRAME**

*Durable yet light enough for transporting.*

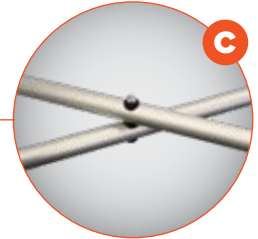

**B. FITS IN ONE BAG**

*Easily folds down & fits into one bag.*



**D. SIMPLIFIED LOCKING SYSTEM**

*Locking arms secure the frame stability.*

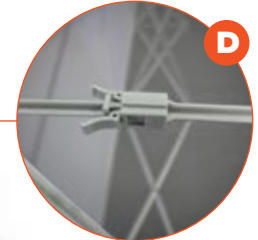

- ✓ Wrinkle Resistant Fabric
- ✓ Free Carrying Bag

**ACCESSORIES**

ITEM #	ITEM	UNIT PRICE	
180016	Light Kit	\$80	(C)



**LIGHT KIT**  
*Includes light, wall charger, & clip system*

POP-UP WALLS

Straight Wall with Wrap Around

FULL DIGITAL PRINT + FRAME

ITEM #	SIZE	1-4	5-9	10-19	20-49	50+
180022	8' x 8'	\$788	\$749	\$709	\$670	\$630
180024	10' x 8'	\$859	\$816	\$773	\$730	\$687 (C)

PRODUCT SPECIFICATIONS

DIMENSIONS	WEIGHT
8' x 8'	21 lbs.
10' x 8'	25 lbs.



Straight Wall

FULL DIGITAL PRINT + FRAME

ITEM #	SIZE	1-4	5-9	10-19	20-49	50+
180021	8' x 8'	\$742	\$705	\$668	\$631	\$594
180023	10' x 8'	\$822	\$781	\$740	\$699	\$658 (C)

PRODUCT SPECIFICATIONS

DIMENSIONS	WEIGHT
8' x 8'	21 lbs.
10' x 8'	25 lbs.



Curved Wall with Wrap Around

FULL DIGITAL PRINT + FRAME

ITEM #	SIZE	1-4	5-9	10-19	20-49	50+
180018	8' x 8'	\$788	\$749	\$709	\$670	\$630
180020	10' x 8'	\$856	\$813	\$770	\$728	\$685 (C)

PRODUCT SPECIFICATIONS

DIMENSIONS	WEIGHT
8' x 8'	21 lbs.
10' x 8'	25 lbs.



Curved Wall

FULL DIGITAL PRINT + FRAME

ITEM #	SIZE	1-4	5-9	10-19	20-49	50+
180017	8' x 8'	\$750	\$713	\$675	\$638	\$600
180019	10' x 8'	\$819	\$778	\$737	\$696	\$655 (C)

PRODUCT SPECIFICATIONS

DIMENSIONS	WEIGHT
8' x 8'	21 lbs.
10' x 8'	25 lbs.



## ▶ QUICK-N-FIT BOOTHS



- ✓ Simplified tubing technology that connects quickly for fast assembly.
- ✓ Travel friendly & easy to transport.



### PRODUCT FEATURES

#### A. CASE-2-COUNTER

*Stores all of your booth items and converts into the frame for your counter.*

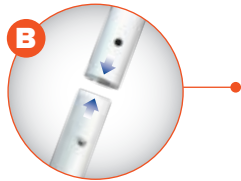

#### B. THUMB LOCK PUSH BUTTON

*Push-button technology to lock and unlock the tubing frame.*



#### C. ALUMINUM POLES

*Strong and durable aluminum tubes.*



#### D. NUMBER MATCHING SYSTEM

*Connect each pole with its respective number to easily assemble.*



#### E. WRINKLE-FREE FITTED FABRIC

*Easily slides on to create a sleek presentation.*



### CASE-2-COUNTER

#### TRAVEL



#### UNLOAD



#### ASSEMBLE



#### PRESENT





## 10' x 10' BOOTHS

### BOOTH 1107

ITEM #	PRICE	INCLUDES	
200009	\$2151	1 Wall, 1 Case/Counter, & 1 Light	(C)

#### PRODUCT SPECIFICATIONS

ITEM	DIMENSIONS	WEIGHT
Wall	95"W x 90"H	16 lbs.
Counter	38"W x 39"H x 19"D	20 lbs.

\*Flooring not included



### BOOTH 1109

ITEM #	PRICE	INCLUDES	
200011	\$2363	1 Wall, 1 Case/Counter, 1 Side Shelf, 1 TV Mount & 1 Light	(C)

#### PRODUCT SPECIFICATIONS

ITEM	DIMENSIONS	WEIGHT
Wall	95"W x 100"H	16 lbs.
Counter	38"W x 39"H x 19"D	20 lbs.
Side Shelf	20"W x 41"H x 14"D	8 lbs.

\*TV and flooring not included



### BOOTH 1111

ITEM #	PRICE	INCLUDES	
200013	\$2485	1 Wall, 1 Banner, 1 Case/Counter, 1 Side Shelf, 1 TV Mount & 1 Light	(C)

#### PRODUCT SPECIFICATIONS

ITEM	DIMENSIONS	WEIGHT
Wall	79"W x 90"H	15 lbs.
Banner	40"W x 90"H	11 lbs.
Counter	38"W x 39"H x 19"D	20 lbs.
Side Shelf	20"W x 41"H x 14"D	8 lbs.

\*TV and flooring not included



### BOOTH 1108

ITEM #	PRICE	INCLUDES	
200010	\$2512	1 Wall, 1 Banner, 1 Case/Counter, 1 Side Shelf, 1 TV Mount & 1 Light	(C)

#### PRODUCT SPECIFICATIONS

ITEM	DIMENSIONS	WEIGHT
Wall	79"W x 100"H	15 lbs.
Banner	40"W x 100"H	12 lbs.
Counter	38"W x 39"H x 19"D	20 lbs.
Side Shelf	20"W x 41"H x 14"D	8 lbs.

\*TV and flooring not included

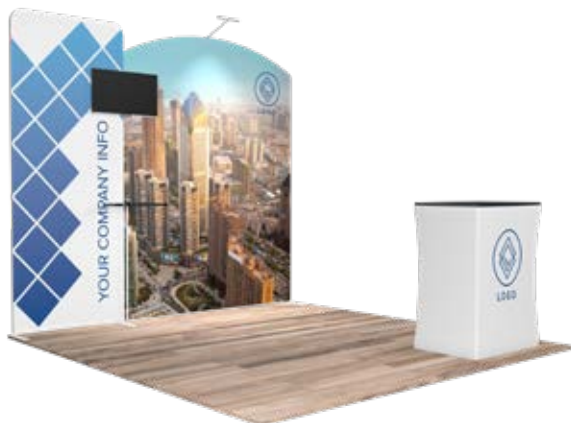

# ▶ QUICK-N-FIT BOOTHS

## 10' × 10' BOOTHS

### BOOTH 1105

ITEM #	PRICE	INCLUDES	
200007	\$2531	1 Wall, 1 Banner, 1 Case/Counter, 1 Side Shelf, 1 TV Mount & 1 Light	(C)

#### PRODUCT SPECIFICATIONS

ITEM	DIMENSIONS	WEIGHT
Wall	79"W × 100"H	16 lbs.
Banner	40"W × 100"H	12 lbs.
Counter	38"W × 39"H × 19"D	20 lbs.
Side Shelf	20"W × 41"H × 14"D	8 lbs.

\*TV and flooring not included



### BOOTH 1104

ITEM #	PRICE	INCLUDES	
200006	\$2512	1 Wall, 1 Banner, 1 Case/Counter, 1 Side Shelf, 1 TV Mount & 1 Light	(C)

#### PRODUCT SPECIFICATIONS

ITEM	DIMENSIONS	WEIGHT
Wall	79"W × 100"H	15 lbs.
Banner	40"W × 100"H	12 lbs.
Counter	38"W × 39"H × 19"D	20 lbs.
Side Shelf	20"W × 41"H × 14"D	8 lbs.

\*TV and flooring not included



### BOOTH 1106

ITEM #	PRICE	INCLUDES	
200008	\$2518	1 Wall, 1 Banner, 1 Case/Counter, 1 TV Mount/Shelf & 1 Light	(C)

#### PRODUCT SPECIFICATIONS

ITEM	DIMENSIONS	WEIGHT
Wall	79"W × 100"H	15 lbs.
Banner	40"W × 102"H	17 lbs.
Counter	38"W × 39"H × 19"D	20 lbs.

\*TV and flooring not included



### BOOTH 1110

ITEM #	PRICE	INCLUDES	
200012	\$2538	1 Wall, 1 Banner, 1 Case/Counter, 1 Side Shelf, 1 TV Mount & 1 Light	(C)

#### PRODUCT SPECIFICATIONS

ITEM	DIMENSIONS	WEIGHT
Wall	79"W × 90"H	15 lbs.
Banner	40"W × 100"H	17 lbs.
Counter	38"W × 39"H × 19"D	20 lbs.
Side Shelf	20"W × 41"H × 14"D	8 lbs.

\*TV and flooring not included



## 10' x 10' BOOTHS

### BOOTH 1101

ITEM #	PRICE	INCLUDES	(C)
200003	\$3649	1 Wall, 1 Tower, 1 Arch, 1 Case/Counter, 1 TV Mount & 1 Light	(C)

#### PRODUCT SPECIFICATIONS

ITEM	DIMENSIONS	WEIGHT
Wall	79"W x 100"H	16 lbs.
Tower	40"W x 120"H x 16"D	42 lbs.
Arch	40"W x 91"H x 102"D	22 lbs.
Counter	38"W x 39"H x 19"D	20 lbs.

\*TV and flooring not included



### BOOTH 1102

ITEM #	PRICE	INCLUDES	(C)
200004	\$2900	1 Wall, 1 Arch, 1 Case/Counter, 1 Side Shelf, 1 TV Mount, & 1 Light	(C)

#### PRODUCT SPECIFICATIONS

ITEM	DIMENSIONS	WEIGHT
Wall	79"W x 100"H	16 lbs.
Arch	40"W x 91"H x 102"D	22 lbs.
Counter	38"W x 39"H x 19"D	20 lbs.
Side Shelf	20"W x 41"H x 14"D	8 lbs.

\*TV and flooring not included



### BOOTH 1103

ITEM #	PRICE	INCLUDES	(C)
200005	\$2490	1 Wall, 1 Banner, 1 Awning/Counter, 1 Side Shelf, 1 TV Mount & 1 Light	(C)

#### PRODUCT SPECIFICATIONS

ITEM	DIMENSIONS	WEIGHT
Wall	79"W x 90"H	15 lbs.
Banner	40"W x 128"H	13 lbs.
Awning/Counter	24"W x 104"H x 118"D	28 lbs.
Side Shelf	20"W x 41"H x 14"D	8 lbs.

\*TV and flooring not included



### BOOTH 1112

ITEM #	PRICE	INCLUDES	(C)
200014	\$2630	1 Wall, 1 Shelf, 1 Case/Counter, 1 TV Mount & 1 Light	(C)

#### PRODUCT SPECIFICATIONS

ITEM	DIMENSIONS	WEIGHT
Wall	115"W x 90"H	16 lbs.
Shelf	28"W x 92"H	28 lbs.
Counter	38"W x 39"H x 19"D	20 lbs.

\*TV, clothing, hangers, and flooring not included



## ▶ QUICK-N-FIT BOOTHS

### 10' × 20' BOOTHS

#### BOOTH 1213

ITEM #	PRICE	INCLUDES
200027	\$4970	1 Wall, 2 Banners, 2 Case/Counters, 2 Side Shelves, (C) 2 TV Mounts & 2 Lights

#### PRODUCT SPECIFICATIONS

ITEM	DIMENSIONS	WEIGHT
Wall	95"W × 128"H	18 lbs.
Banner	59"W × 100"H	14 lbs.
Counter	38"W × 39"H × 19"D	20 lbs.
Side Shelf	20"W × 41"H × 14"D	8 lbs.

\*TVs and flooring not included



#### BOOTH 1209

ITEM #	PRICE	INCLUDES
200023	\$4892	1 Wall, 2 Banners, 2 Case/Counters, 2 Side Shelves, (C) 2 TV Mounts & 2 Lights

#### PRODUCT SPECIFICATIONS

ITEM	DIMENSIONS	WEIGHT
Wall	95"W × 100"H	16 lbs.
Banner	59"W × 100"H	14 lbs.
Counter	38"W × 39"H × 19"D	20 lbs.
Side Shelf	20"W × 41"H × 14"D	8 lbs.

\*TVs and flooring not included



#### BOOTH 1207

ITEM #	PRICE	INCLUDES
200021	\$4824	1 Wall, 2 Banners, 2 Case/Counters, 2 Side Shelves, (C) 2 TV Mounts & 2 Lights

#### PRODUCT SPECIFICATIONS

ITEM	DIMENSIONS	WEIGHT
Wall	95"W × 100"H	16 lbs.
Banner	59"W × 90"H	14 lbs.
Counter	38"W × 39"H × 19"D	20 lbs.
Side Shelf	20"W × 41"H × 14"D	8 lbs.

\*TVs and flooring not included



#### BOOTH 1206

ITEM #	PRICE	INCLUDES
200020	\$4915	3 Walls, 2 Case/Counters, 2 Side Shelves, (C) 1 TV Mount & 2 Lights

#### PRODUCT SPECIFICATIONS

ITEM	DIMENSIONS	WEIGHT
Curved Wall	79"W × 100"H	15 lbs.
Wall	79"W × 100"H	16 lbs.
Counter	38"W × 39"H × 19"D	20 lbs.
Side Shelf	20"W × 41"H × 14"D	8 lbs.

\*TV and flooring not included





## 10' x 20' BOOTHS

### BOOTH 1203

ITEM #	PRICE	INCLUDES	
200017	\$5487	3 Walls, 1 Arch, 2 Case/Counters, 2 Side Shelves, 1 TV Mount, & 2 Lights	(C)

#### PRODUCT SPECIFICATIONS

ITEM	DIMENSIONS	WEIGHT
Curved Wall	79"W x 100"H	15 lbs.
Wall	79"W x 90"H	15 lbs.
Arch	40"W x 91"H x 102"D	22 lbs.
Counter	38"W x 39"H x 19"D	20 lbs.
Side Shelf	20"W x 41"H x 14"D	8 lbs.

\*TV and flooring not included



### BOOTH 1215

ITEM #	PRICE	INCLUDES	
200029	\$4920	3 Walls, 2 Case/Counters, 2 Side Shelves, 2 TV Mounts & 2 Lights	(C)

#### PRODUCT SPECIFICATIONS

ITEM	DIMENSIONS	WEIGHT
Wall	79"W x 100"H	15 lbs.
Counter	38"W x 39"H x 19"D	20 lbs.
Side Shelf	20"W x 41"H x 14"D	8 lbs.

\*TVs and flooring not included



### BOOTH 1212

ITEM #	PRICE	INCLUDES	
200026	\$4845	1 Wall, 2 Banners, 2 Case/Counters, 2 Side Shelves, 2 TV Mounts & 2 Lights	(C)

#### PRODUCT SPECIFICATIONS

ITEM	DIMENSIONS	WEIGHT
Wall	95"W x 100"H	16 lbs.
Banner	59"W x 100"H	14 lbs.
Counter	38"W x 39"H x 19"D	20 lbs.
Side Shelf	20"W x 41"H x 14"D	8 lbs.

\*TVs and flooring not included



### BOOTH 1208

ITEM #	PRICE	INCLUDES	
200022	\$4822	1 Wall, 2 Banners, 2 Case/Counters, 2 Side Shelves, 1 TV Mount & 2 Lights	(C)

#### PRODUCT SPECIFICATIONS

ITEM	DIMENSIONS	WEIGHT
Wall	95"W x 100"H	16 lbs.
Angled Banner	59"W x 100"H	14 lbs.
Curved Banner	59"W x 100"H	14 lbs.
Counter	38"W x 39"H x 19"D	20 lbs.
Side Shelf	20"W x 41"H x 14"D	8 lbs.

\*TV and flooring not included



# ▶ QUICK-N-FIT BOOTHS

## 10' × 20' BOOTHS

### BOOTH 1204

ITEM #	PRICE	INCLUDES
200018	\$4866	1 Wall, 2 Banners, 2 Case/Counters, 2 Side Shelves, (C) 2 TV Mounts & 2 Lights

#### PRODUCT SPECIFICATIONS

ITEM	DIMENSIONS	WEIGHT
Wall	95"W x 100"H	16 lbs.
Banner	60"W x 100"H	14 lbs.
Counter	38"W x 39"H x 19"D	20 lbs.
Side Shelf	20"W x 41"H x 14"D	8 lbs.

\*TVs and flooring not included



### BOOTH 1210

ITEM #	PRICE	INCLUDES
200024	\$4754	2 Walls, 1 Banner, 2 Case/Counters, 1 Side Shelf, (C) 1 TV Mount & 2 Lights

#### PRODUCT SPECIFICATIONS

ITEM	DIMENSIONS	WEIGHT
Wall	95"W x 90"H	16 lbs.
Banner	40"W x 128"H	13 lbs.
Counter	38"W x 39"H x 19"D	20 lbs.
Side Shelf	20"W x 41"H x 14"D	8 lbs.

\*TV and flooring not included



### BOOTH 1218

ITEM #	PRICE	INCLUDES
200032	\$5026	2 Walls, 2 Banners, 2 Case/Counters, (C) 2 Side Shelves, 2 TV Mounts & 2 Lights

#### PRODUCT SPECIFICATIONS

ITEM	DIMENSIONS	WEIGHT
Wall	79"W x 100"H	15 lbs.
Banner	40"W x 100"H	12 lbs.
Counter	38"W x 39"H x 19"D	20 lbs.
Side Shelf	20"W x 41"H x 14"D	8 lbs.

\*TVs and flooring not included



### BOOTH 1205

ITEM #	PRICE	INCLUDES
200019	\$5109	2 Walls, 2 Banners, 2 Case/Counters, (C) 2 Side Shelves, 2 TV Mounts & 2 Lights

#### PRODUCT SPECIFICATIONS

ITEM	DIMENSIONS	WEIGHT
Wall	79"W x 100"H	15 lbs.
Banner	40"W x 128"H	13 lbs.
Counter	38"W x 39"H x 19"D	20 lbs.
Side Shelf	20"W x 41"H x 14"D	8 lbs.

\*TVs and flooring not included



## 10' x 20' BOOTHS

### BOOTH 1214

ITEM #	PRICE	INCLUDES	
200028	\$5096	2 Walls, 2 Banners, 2 Case/Counters, 2 Side Shelves, 2 TV Mounts & 2 Lights	(C)

#### PRODUCT SPECIFICATIONS

ITEM	DIMENSIONS	WEIGHT
Wall	79"W x 100"H	15 lbs.
Banner	40"W x 100"H	17 lbs.
Counter	38"W x 39"H x 19"D	20 lbs.
Side Shelf	20"W x 41"H x 14"D	8 lbs.

\*TVs and flooring not included



### BOOTH 1216

ITEM #	PRICE	INCLUDES	
200030	\$4929	2 Walls, 1 Banner, 2 Case/Counters, 2 Side Shelves, 1 TV Mount & 2 Lights	(C)

#### PRODUCT SPECIFICATIONS

ITEM	DIMENSIONS	WEIGHT
Wall	95"W x 90"H	16 lbs.
Banner	40"W x 100"H	17 lbs.
Counter	38"W x 39"H x 19"D	20 lbs.
Side Shelf	20"W x 41"H x 14"D	8 lbs.

\*TV and flooring not included



### BOOTH 1217

ITEM #	PRICE	INCLUDES	
200031	\$4738	2 Walls, 1 Banner, 2 Case/Counters, 1 TV Mount/Shelf & 2 Lights	(C)

#### PRODUCT SPECIFICATIONS

ITEM	DIMENSIONS	WEIGHT
Wall	95"W x 100"H	16 lbs.
Banner	40"W x 102"H	17 lbs.
Counter	38"W x 39"H x 19"D	20 lbs.

\*TV and flooring not included



### BOOTH 1211

ITEM #	PRICE	INCLUDES	
200025	\$5202	1 Wall, 4 Banners, 2 Case/Counters, 2 Side Shelves, 2 TV Mounts & 2 Lights	(C)

#### PRODUCT SPECIFICATIONS

ITEM	DIMENSIONS	WEIGHT
Wall	79"W x 90"H	15 lbs.
Angled Banner	40"W x 100"H	12 lbs.
Curved Banner	40"W x 100"H	17 lbs.
Counter	38"W x 39"H x 19"D	20 lbs.
Side Shelf	20"W x 41"H x 14"D	8 lbs.

\*TVs and flooring not included



# QUICK-N-FIT BOOTHS

## 10' x 20' BOOTHS

### BOOTH 1201

ITEM #	PRICE	INCLUDES	
200015	\$6568	4 Banners, 2 Towers, 2 Arches, 1 Case/Counter, 2 Side Shelves, 2 TV Mounts & 2 Lights	(C)

#### PRODUCT SPECIFICATIONS

ITEM	DIMENSIONS	WEIGHT
Banner	40"W x 90"H	11 lbs.
Tower	40"W x 120"H x 16"D	42 lbs.
Arch	40"W x 91"H x 102"D	22 lbs.
Counter	38"W x 39"H x 19"D	20 lbs.
Side Shelf	20"W x 41"H x 14"D	8 lbs.

\*TVs and flooring not included



### BOOTH 1202

ITEM #	PRICE	INCLUDES	
200016	\$6541	2 Walls, 1 Tower, 1 Arch, 2 Case/Counters, 1 TV Mount & 2 Lights	(C)

#### PRODUCT SPECIFICATIONS

ITEM	DIMENSIONS	WEIGHT
Wall	95"W x 100"H	16 lbs.
Tower	40"W x 120"H x 16"D	42 lbs.
Arch	40"W x 91"H x 102"D	22 lbs.
Counter	38"W x 39"H x 19"D	20 lbs.

\*TV and flooring not included



### BOOTH 1219

ITEM #	PRICE	INCLUDES	
200033	\$5858	1 Wall, 2 Display Counters, 1 Case/Counter & 2 Lights	(C)

#### PRODUCT SPECIFICATIONS

ITEM	DIMENSIONS	WEIGHT
Wall	235"W x 90"H	25 lbs.
Display Counter	37"W x 78"H x 18"D	41 lbs.
Counter	38"W x 39"H x 19"D	20 lbs.

\*Flooring not included



### BOOTH 1220

ITEM #	PRICE	INCLUDES	
200034	\$6217	3 Walls, 2 Banners, 6 Shelves, 2 TV Mounts & 2 Lights	(C)

#### PRODUCT SPECIFICATIONS

ITEM	DIMENSIONS	WEIGHT
Wall	95"W x 90"H	16 lbs.
Left Wall	79"W x 90"H	15 lbs.
Banner	40"W x 128"H	13 lbs.
Clothing Shelf	28"W x 92"H	28 lbs.
Shelf	28"W x 92"H	26 lbs.

\*TVs, clothing, hangers and flooring not included





## 20' x 20' BOOTHS

### BOOTH 2201

ITEM #	PRICE	INCLUDES	
200035	\$5195	1 Tower, 2 Arches, 2 Case/Counters, & 2 Lights	(C)

#### PRODUCT SPECIFICATIONS

ITEM	DIMENSIONS	WEIGHT
Tower	40"W x 120"H x 16"D	42 lbs.
Arch	40"W x 91"H x 102"D	22 lbs.
Counter	38"W x 39"H x 19"D	20 lbs.

\*Flooring not included



### BOOTH 2202

ITEM #	PRICE	INCLUDES	
200036	\$9009	4 Towers, 4 Case/Counters, 8 Side Shelves, 4 TV Mounts & 4 Lights	(C)

#### PRODUCT SPECIFICATIONS

ITEM	DIMENSIONS	WEIGHT
Tower	40"W x 120"H x 16"D	42 lbs.
Counter	38"W x 39"H x 19"D	20 lbs.
Side Shelf	10"W x 40"L	8 lbs.

\*TVs and flooring not included



## ▶ QUICK-N-FIT BANNERS & WALLS



- ✓ Easy to assemble with tubing technology.
- ✓ The snug fitting sleeve provides a smooth presentation of your high resolution printed graphics.



### PRODUCT FEATURES

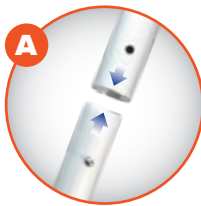

**A. THUMB LOCK PUSH BUTTON**  
*Push button technology to lock and unlock the tubing frame.*

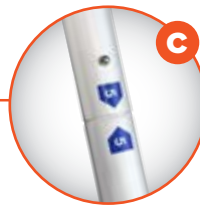

**C. NUMBER MATCHING SYSTEM**  
*Connect each pole with its respective number to easily assemble.*



**B. ALUMINUM POLES**  
*Strong and durable aluminum tubes.*



**D. WRINKLE-FREE FITTED FABRIC**  
*Easily slides on to create a sleek presentation.*



## TENSION BANNERS

### FULL DIGITAL PRINT + FRAME

ITEM #	SIZE	1-4	5-9	10-19	20-49	50+
200061	2' x 7.5'	\$319	\$303	\$287	\$271	\$255
200062	3' x 7.5'	\$353	\$335	\$318	\$300	\$282 (C)

### PRODUCT SPECIFICATIONS

SIZE	WEIGHT
2' x 7.5'	17 lbs.
3' x 7.5'	21 lbs.

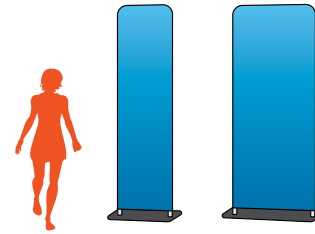

## STRAIGHT TENSION WALLS

### FULL DIGITAL PRINT + FRAME

ITEM #	SIZE	1-4	5-9	10-19	20-49	50+
200065	8' x 7.5'	\$808	\$768	\$727	\$687	\$646
200066	10' x 7.5'	\$888	\$844	\$799	\$755	\$710
200067	20' x 7.5'	\$1407	\$1337	\$1266	\$1196	\$1126 (C)

### PRODUCT SPECIFICATIONS

SIZE	WEIGHT
8' x 7.5'	19 lbs.
10' x 7.5'	20 lbs.
20' x 7.5'	36 lbs.

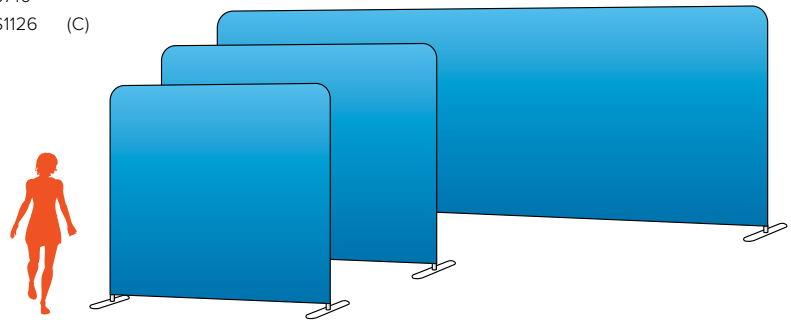

## CURVED TENSION WALLS

### FULL DIGITAL PRINT + FRAME

ITEM #	SIZE	1-4	5-9	10-19	20-49	50+
200068	8' x 7.5'	\$808	\$768	\$727	\$687	\$646
200069	10' x 7.5'	\$888	\$844	\$799	\$755	\$710
200070	20' x 7.5'	\$1407	\$1337	\$1266	\$1196	\$1126 (C)

### PRODUCT SPECIFICATIONS

SIZE	WEIGHT
8' x 7.5'	14 lbs.
10' x 7.5'	18 lbs.
20' x 7.5'	33 lbs.

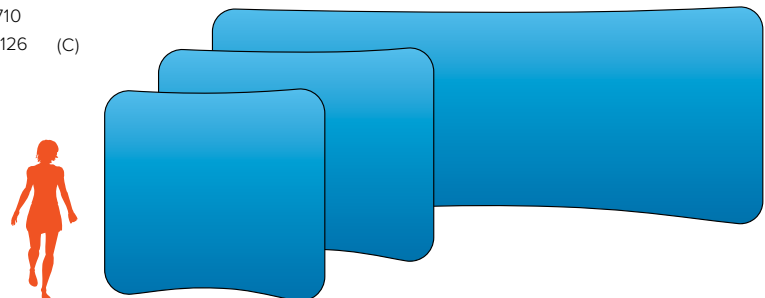

CUSTOM PRINTED EVENT FLOORING



# EASILY ROLLABLE CUSTOM FLOORING FOR EVENTS

Our rollable custom printed floorings are ideal for all professional events. Their durable material is convenient, lightweight, and cost-effective. These rollable floorings are available in various beautiful designer styles, including hard-wood and stone-look flooring. We also offer custom printed options, for you to showcase your brand from the floor to the ceiling!

- ✓ Fast and Easy Installation
- ✓ Exclusive Design Patterns
- ✓ Indoor / Outdoor
- ✓ Easy to Clean



**FREE!**

**HEAVY DUTY WHEELED HARDCASE** provides a convenient way to transport and ship your flooring.

**PACKAGES AVAILABLE:**

**STOCK COLORS AVAILABLE:**

**10'x10'**

**10'x20'**

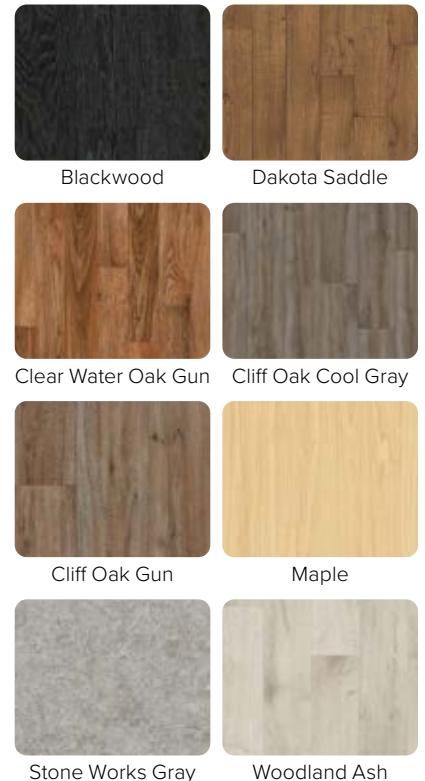
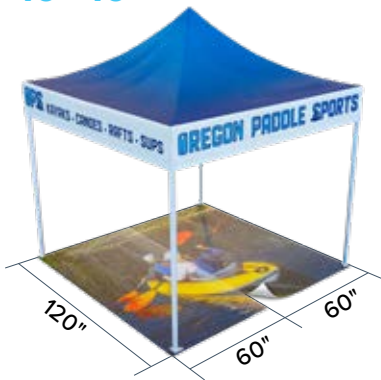

**10'x10' PACKAGE**

**10'x20' PACKAGE**

STOCK COLOR	FULL DIGITAL PRINT
\$1595	\$3299 (C)

STOCK COLOR	FULL DIGITAL PRINT
\$3195	\$6599 (C)

**PACKAGE INCLUDES:**

- 2x SECTIONS 60"x120" High traffic event grade vinyl flooring
- 1/4" Step padding for elevated comfort
- 1x Heavy duty **HARDCASE** for easy transport and shipping

**PACKAGE INCLUDES:**

- 2x SECTIONS 60"x240" High traffic event grade vinyl flooring
- 1/4" Step padding for elevated comfort
- 2x Heavy duty wheeled **HARDCASES** for transport and shipping



## CUSTOM PRINTED DECK CHAIR

Our premium aluminum frame **sling chairs** are perfect for creating a cozy ambiance in your outdoor lounge areas. Whether it's for movies, concerts, or sporting events, these deckchairs combine comfort, style, and durability. Elevate your events with comfortable and eye-catching seating, creating a memorable experience.



**A. EASY TO SET UP.**  
convenient, foldable chair  
and removable seat

**B. 4 ADJUSTABLE  
POSITIONS.** simple  
mechanism

**C. PROFESSIONAL  
GRADE ANODIZED ALUMINUM**  
heavy-duty frame

- ✓ Long-lasting frame
- ✓ Easy to set up
- ✓ Custom printed polyester seat
- ✓ Interchangeable graphics
- ✓ Rust-free guarantee
- ✓ Ideal for beach and snow

### BEACH CHAIR (FULLY PRINTED FABRIC + FRAME)

ITEM #	INCLUDES	6-24	25-50	51-100	101-149	150+	(C)
300002	Fabric & Frame	\$189	\$180	\$170	\$161	\$151	

### PRODUCT SPECIFICATIONS

SIZE	WEIGHT
35"×23"×36"	8lbs.



## ▶ BRANDED FOLDING CHAIR

### A. MULTIPLE PRINT LOCATIONS

Your logo can be printed on the front or the back of chair backrest as well as on the carrying bag



From corporate events to sporting events and even festivals, these branded folding chairs are a great solution for providing comfortable seating while showcasing your brand.

### B. 2 MESH CUP HOLDERS

Convenient for placing beverages



### E. 600 DENIER POLYESTER

Strong and weather resilient material



### D. POWDER COATED STEEL FRAME

Durable composition that is lasting



### C. PROTECTIVE CARRYING BAG

Easy to store and transport



### PRODUCT SPECIFICATIONS

PRODUCT DIMENSIONS 41.5"W x 18.5"D x 35"H  
 SEAT HEIGHT 16"H  
 WEIGHT 6 lbs  
 IMPRINT SIZE: 12"W x 3.5"H

### COLORS AVAILABLE



- Purple PMS 267C\*
- Red PMS 186C\*
- Royal PMS 293C\*
- Navy PMS 540C\*
- Green PMS 2410C\*
- Black PMS 6C\*

\*PMS colors are for reference only and may vary slightly from actual color

### SPORT FOLDING CHAIR with CARRY CASE

ITEM#	DESCRIPTION	Minimum Qty	1-4	5-9	10-19	20-49	50+	PRINTING MULTIPLE LOCATIONS**		
								1 Location	2 Locations	3 Locations
270001	One Color Print (600 Denier Polyester)	4	\$66	\$59	\$46	\$40	\$33	Included	+\$10 / Chair	+\$15 / Chair (C)
270002	Full Color Print (600 Denier Polyester)	4	\$83	\$75	\$58	\$50	\$42			

\*\* 3 Available Locations: Front of the Backrest, Back of the Backrest, Carrying Bag

## GRAPHICS & PRINTING

---

### In-House Design Services

We offer complimentary design services to help you create just what you're envisioning. Our professional, in-house designers are here to help you create print-ready quality **design layouts** and **3D mock-ups** for product presentations.

### File Formats Accepted

#### Vector File Types (Preferred)

- .AI (Illustrator File)
- .EPS
- .PDF (Fonts outlined & images embedded)

#### Other File Types

- .PSD (Photoshop)
- .JPG
- .PNG
- .TIFF

We recommend submitting graphics in vector format for a crisp, clear print. Images should be in high resolution (at least 150 dpi) at full size to ensure a clear print.

### Vector Logo Recreation

If your artwork isn't in the right format, don't worry because we can help! We can recreate any file into the correct format for just **\$65/hr**. This service will give you peace of mind to know that your logo will print in high-quality. We can even provide the vector files for your future use.

### Colors

To match your colors accurately, please provide **100% opaque PANTONE® Solid Coated (PMS C)** colors for reproduction. Please submit your files in **CMYK** color mode.

### Printing

Our printing workshop guarantees high resolution printing on all your products. We know that every product is used differently, which is why we offer multiple printing techniques from **dye-sublimation printing** to **screen printing** to prepare for every type of environment.

### Samples Available

We offer fabric samples for all our printed and stock color products. If you need to match an exact color, we can print a swatch with your design on most materials for a small cost. Please allow extra time for the production process in order for us to provide samples.



**#1** *RELIABLE SOURCE FOR ALL YOUR CUSTOM*  
**TENTS & SIGNAGE**

Distributed by: