

ASI 89955  
SAGE 57801  
PPAI 114212  
UPIC 1ASTRMBG

**INVERTED** **FOLDING** **GOLF** **FASHION** **PATIO** **UV** **CUSTOM**



[WWW.STROMBERGBRAND.COM](http://WWW.STROMBERGBRAND.COM)

**2022**



FOLDING

INVERTED

GOLF

FASHION

AUTO

PATIO

ITEM #	NAME		PG #
<b>SB-1200</b> (Formerly Item# 42EZF)	The Spectrum Folding Umbrella   Auto-Open	As Low As \$7.68(C)	4-5
<b>SB-1201</b> (Formerly Item# 42EZF-PATRIOT)	The Patriot Folding Umbrella   Auto-Open	As Low As \$9.28(C)	5
<b>SB-1202</b>	<b>NEW – The Heather Spectrum Folding Umbrella   Auto-Open</b>	As Low As \$9.98(C)	6
<b>SB-1208</b>	<b>NEW – The Packman Folding Umbrella   Auto-Open</b>	As Low As \$8.28(C)	7
<b>SB-1100</b> (Formerly Item# 41MN)	The Compact Econo Folding Umbrella   Manual Open	As Low As \$6.48(C)	8
<b>SB-1210</b> (Formerly Item# 85EZW-V)	The Vented Windproof Folding Umbrella   Auto-Open	As Low As \$10.78(C)	9
<b>SB-1620</b>	The Vented Cosmopolitan Folding Umbrella   Auto-Open	As Low As \$10.98(C)	10
<b>SB-1310</b> (Formerly Item# 488FGR-V)	The Vented Grand Practicality Folding Umbrella   Auto-Open	As Low As \$10.78(C)	11
<b>SB-4120</b> (Formerly Item# 107LIF-V)	The Vented Lifesaver Folding Umbrella   Auto-Open	As Low As \$11.68(C)	12
<b>SB-1650</b> (Formerly Item# 97AOC-V)	The Vented Mighty Mite Folding Umbrella   Auto-Open & Auto-Close	As Low As \$12.88(C)	13
<b>SB-1700</b> (Formerly Item# 58EZF-V)	The Vented Little Giant Folding Umbrella   Auto-Open	As Low As \$13.68(C)	14
<b>SB-1702</b>	<b>NEW – The Vented Heather Little Giant Folding Umbrella   Auto-Open</b>	As Low As \$16.98(C)	15
<b>SB-1410</b> (Formerly Item# 112COL-V)	The Vented Color Crown Folding Umbrella   Auto-Open	As Low As \$11.28(C)	16
<b>SB-1720</b> (Formerly Item# 130COL-V)	The Vented Colossal Crown Folding Umbrella   Auto-Open	As Low As \$14.38(C)	17
<b>SB-1670</b> (Formerly Item# 115DIR-V)	The Vented Director Folding Umbrella   Auto-Open & Auto-Close	As Low As \$15.38(C)	18
<b>SB-1640</b>	The Super Mini Folding Umbrella   Auto-Open & Auto-Close	As Low As \$10.98(C)	19
<b>SB-4675</b>	The Color Flip Inverted Folding Umbrella   Auto-Open & Auto-Close	As Low As \$15.98(C)	20-21
<b>SB-4676</b>	The Skyview Inverted Folding Umbrella   Auto-Open & Auto-Close	As Low As \$16.48(C)	22
<b>SB-4677</b>	The Leopard Flip Inverted Folding Umbrella   Auto-Open & Auto-Close	As Low As \$16.48(C)	22
<b>SB-4650</b>	The Reversa Inverted Folding Umbrella   Auto-Open & Auto-Close	As Low As \$14.38(C)	23
<b>SB-4620</b>	The Viceversa Inverted Umbrella   Manual Open	As Low As \$14.98(C)	24
<b>SB-4621</b>	The Leopard Viceversa Inverted Umbrella   Manual Open	As Low As \$15.98(C)	25
<b>SB-4600</b>	The Inversa Inverted Umbrella   Auto-Open	As Low As \$17.98(C)	26-27
<b>SB-4602</b>	<b>NEW – The Heather Inversa Inverted Umbrella   Auto-Open</b>	As Low As \$18.98(C)	27
<b>SB-4601</b>	The Blue Sky & Clouds Inverted Umbrella   Auto-Open	As Low As \$18.98(C)	28
<b>SB-4680</b>	The Grand Inversa Inverted Umbrella   Manual Open	As Low As \$19.98(C)	29
<b>SB-2100</b> (Formerly Item# 103ST)	The Ultra Value Golf Umbrella   Auto-Open	As Low As \$11.58(C)	30
<b>SB-2120</b> (Formerly Item# 106ST-V)	The Vented Club Canopy Golf Umbrella   Auto-Open	As Low As \$13.58(C)	31
<b>SB-2200</b> (Formerly Item# 62AFG)	The Hole-In-One Golf Umbrella   Manual Open	As Low As \$13.98(C)	32
<b>SB-2400</b>	The Vented Checkerboard Golf Umbrella   Auto-Open	As Low As \$16.58(C)	33
<b>SB-2320</b> (Formerly Item# TT30-V)	The Vented Typhoon Tamer Golf Umbrella   Manual Open	As Low As \$15.58(C)	34-35
<b>SB-2500</b> (Formerly Item# 83TOR-V)	The Vented Tornado Golf Umbrella   Auto-Open	As Low As \$19.78(C)	36
<b>SB-2450</b> (Formerly Item# 119PAR-V)	The Vented Paramount Golf Umbrella   Auto-Open	As Low As \$20.58(C)	37
<b>SB-2700</b> (Formerly Item# 108UVB-V)	The Vented Uv Golf/Beach/Event Umbrella   Manual Open	As Low As \$25.98(C)	38
<b>SB-3200</b>	The City Slicker Fashion Umbrella   Auto-Open	As Low As \$8.98(C)	39
<b>SB-3150</b>	The Continental Fashion Umbrella   Auto-Open	As Low As \$9.48(C)	40
<b>SB-3120</b> (Formerly Item# 24WSO-V)	The Vented Urban Brolly Fashion Umbrella   Auto-Open	As Low As \$11.98(C)	41
<b>SB-7100</b>	<b>NEW – The Dashboard Defender Umbrella   Manual Open</b>	As Low As \$19.88(C)	42-43
<b>SB-5500</b> (Formerly Item# 117BIS-V)	The Vented Bistro Patio Umbrella   Manual Open	As Low As \$144.98(C)	44-45
<b>SB-9260</b>	Free-Standing High-Density Textured Plastic Base	As Low As \$49.98(C)	44-45
<b>SB-5700</b>	The Vented Ultimate Patio Umbrella   Manual Open	As Low As \$210.98(C)	46

CUSTOM	47
4-COLOR PROCESS PRINTING & LASER ENGRAVING	48
GENERAL INFORMATION	49

# New Items For 2022!



**Heather Spectrum Folding Umbrella**  
SB-1202  
As Low As **\$9.98(C)**  
*See pg 6 for details*



**PackMan Folding Umbrella**  
SB-1208  
As Low As **\$8.28(C)**  
*See pg 7 for details*



**Vented Heather Little Giant Folding Golf Umbrella**  
SB-1702  
As Low As **\$16.98(C)**  
*See pg 15 for details*



**Heather Inversa Inverted Umbrella**  
SB-4602  
As Low As **\$18.98(C)**  
*See pg 27 for details*

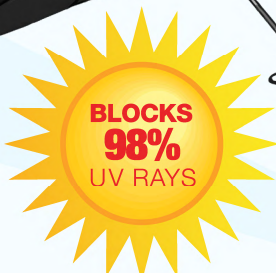

**Dashboard Defender UV Car Windshield Umbrella**  
SB-7100  
As Low As **\$19.88(C)**  
*See pg 42 for details*



Our Most Colorful Style!



4-Color Process Print Available! See Page 48

Shown with optional case imprint!



# The Spectrum Folding Umbrella

SB-1200 (Formerly Item# 42EZF)

- Automatic opening
- Sturdy metal shaft
- Rubberized black handle with wrist strap
- Matching fabric case

Arc: 42"      Number Of Panels: 8  
 Diameter: 38"      Length When Closed: 15"  
 Opening: Automatic      Imprint Area: 6"H x 7"W

Shipping weight 48 pieces: 35 Lbs. Box Dimensions: 17" x 14" x 10"

Price includes: 1-Color, 1-Location imprint  
 Extra print(s): \$1.25 (G) per color, per location  
 Undercanopy printing: \$2.00 (G) plus setup  
 Case printing: \$2.00 (G) plus setup  
 Wide Tie printing: \$2.00 (G) plus setup  
 Setup: \$65.00 (G) per color, per design  
 Process Color printing: See page 48  
 Delivery: 5-7 working days from all approvals

Prices and specifications are subject to change. Refer to [www.strombergbrand.com](http://www.strombergbrand.com) for the most up-to-date information.

12	24	48	96	240	480	1008	
13.98	10.48	9.78	9.28	8.68	8.18	7.68	(C)



Click here to view this umbrella in action on YouTube!



Over 30 Available Colors!





SB-1200  
Shown Here



# The Patriot Folding Umbrella

SB-1201 (Formerly Item# 42EZF-PATRIOT)

Same great features as the SB-1200, with a bold patriotic stars and stripes design!

12	24	48	96	240	480	1008
17.98	12.98	12.28	11.58	10.88	10.08	9.28 (C)





Luxurious New  
Heather Fabric!



**NEW!**



  
**4-Color Process Print Available!**  
 See Page 48

## The Heather Spectrum Folding Umbrella

SB-1202

- Automatic opening
- Sturdy metal shaft
- Rubberized black handle with wrist strap
- Matching fabric case

12	24	48	96	240	480	1008
18.98	13.98	13.18	12.38	11.58	10.78	9.98 (C)

**Arc:** 42"      **Number Of Panels:** 8  
**Diameter:** 38"      **Length When Closed:** 15"  
**Opening:** Automatic      **Imprint Area:** 6"H x 7"W

Shipping weight 48 pieces: 35 Lbs. Box Dimensions: 17" x 14" x 10"

**Price includes:** 1-Color, 1-Location imprint  
**Extra print(s):** \$1.25 (G) per color, per location  
**Undercanopy printing:** \$2.00 (G) plus setup  
**Case printing:** \$2.00 (G) plus setup  
**Wide Tie printing:** \$2.00 (G) plus setup  
**Setup:** \$65.00 (G) per color, per design  
**Process Color printing:** See page 48  
**Delivery:** 5-7 working days from all approvals

Prices and specifications are subject to change.  
 Refer to [www.strombergbrand.com](http://www.strombergbrand.com) for the most up-to-date information.

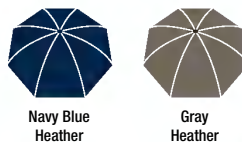

Shown with optional case imprint!

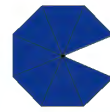

Take A BITE Out of Your Next Promo!



NEW!



4-Color Process Print Available! See Page 48

# The PackMan Folding Umbrella

## SB-1208

- Automatic opening
- Sturdy metal shaft
- Rubberized black handle with wrist strap
- Matching fabric case

12	24	48	96	240	480	1008
14.98	10.98	10.18	9.78	9.28	8.78	8.28 (C)

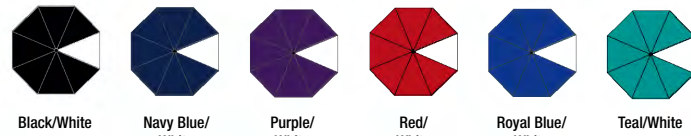

Arc: 42"      Number Of Panels: 8  
 Diameter: 38"      Length When Closed: 15"  
 Opening: Automatic      Imprint Area: 6"H x 7"W

Shipping weight 48 pieces: 35 Lbs. Box Dimensions: 17" x 14" x 10"

**Price includes:** 1-Color, 1-Location imprint  
**Extra print(s):** \$1.25 (G) per color, per location  
**Undercanopy printing:** \$2.00 (G) plus setup  
**Case printing:** \$2.00 (G) plus setup  
**Wide Tie printing:** \$2.00 (G) plus setup  
**Setup:** \$65.00 (G) per color, per design  
**Process Color printing:** See page 48  
**Delivery:** 5-7 working days from all approvals

Prices and specifications are subject to change. Refer to [www.strombergbrand.com](http://www.strombergbrand.com) for the most up-to-date information.



Shown with optional case imprint!



Great Quality,  
Amazing Price!



  
4-Color Process Print  
Available!  
See Page 48

Folds To Just 9"!

## The Compact Econo Folding Umbrella

SB-1100 (Formerly Item# 41MN)

- Manual opening
- Sturdy metal shaft
- Fiberglass rib ends with ball tips
- Matte black handle with wrist strap
- Matching fabric case

**Arc:** 41"      **Number Of Panels:** 8  
**Diameter:** 38"      **Length When Closed:** 9"  
**Opening:** Manual      **Imprint Area:** 5"H x 7"W

Shipping weight 60 pieces: 33 Lbs. Box Dimensions: 10" x 10" x 18"

Shown with optional  
case imprint!



12	24	48	96	240	480	1008
12.98	8.98	8.48	7.98	7.48	6.98	6.48 (C)



**Price includes:** 1-Color, 1-Location imprint  
**Extra print(s):** \$1.25 (G) per color, per location  
**Undercanopy printing:** \$2.00 (G) plus setup  
**Case printing:** \$2.00 (G) plus setup  
**Wide Tie printing:** \$2.00 (G) plus setup  
**Setup:** \$65.00 (G) per color, per design  
**Process Color printing:** See page 48  
**Delivery:** 5-7 working days from all approvals

Prices and specifications are subject to change.  
Refer to [www.strombergbrand.com](http://www.strombergbrand.com) for the most up-to-date information.







  
**4-Color Process Print Available!**  
 See Page 48

Windproof Frame!



# The Vented Windproof Folding Umbrella

SB-1210 (Formerly Item# 85EZW-V)

- Automatic opening
- Windproof frame construction
- Sturdy metal shaft
- Rubberized matching handle with wrist strap
- Matching fabric case

12	24	48	96	240	480	1008
19.48	14.48	13.98	13.28	12.48	11.58	10.78 (C)



**Arc:** 42"      **Number Of Panels:** 8  
**Diameter:** 38"      **Length When Closed:** 15"  
**Opening:** Automatic      **Imprint Area:** 5"H x 7"W  
**Shipping weight 48 pieces:** 38 Lbs. **Box Dimensions:** 20" x 7" x 17"

**Price includes:** 1-Color, 1-Location imprint  
**Extra print(s):** \$1.25 (G) per color, per location  
**Undercanopy printing:** \$2.00 (G) plus setup  
**Case printing:** \$2.00 (G) plus setup  
**Wide Tie printing:** \$2.00 (G) plus setup  
**Setup:** \$65.00 (G) per color, per design  
**Process Color printing:** See page 48  
**Delivery:** 5-7 working days from all approvals

Click here to view this umbrella in action on YouTube!



Prices and specifications are subject to change. Refer to [www.strombergbrand.com](http://www.strombergbrand.com) for the most up-to-date information.





4-Color Process Print Available!  
See Page 48

Windproof Frame!

# The Vented Cosmopolitan Folding Umbrella

SB-1620

- Automatic opening
- Windproof frame construction
- Fashionable square-shaped wind vent
- Deluxe black metal 3-section shaft
- Rubberized black handle with wrist strap
- Matching fabric case

Arc: 44"      Number Of Panels: 8  
 Diameter: 38"      Length When Closed: 12"  
 Opening: Automatic      Imprint Area: 5"H x 7"W  
 Shipping weight 36 pieces: 33 Lbs. Box Dimensions: 13" x 13" x 13"

Shown with optional case imprint!



12	24	48	96	240	480	1008
19.98	14.98	14.18	13.38	12.58	11.78	10.98 (C)



**Price includes:** 1-Color, 1-Location imprint  
**Extra print(s):** \$1.25 (G) per color, per location  
**Undercanopy printing:** \$2.00 (G) plus setup  
**Case printing:** \$2.00 (G) plus setup  
**Wide Tie printing:** \$2.00 (G) plus setup  
**Setup:** \$65.00 (G) per color, per design  
**Process Color printing:** See page 48  
**Delivery:** 5-7 working days from all approvals

Prices and specifications are subject to change.  
 Refer to [www.strombergbrand.com](http://www.strombergbrand.com) for the most up-to-date information.





Shown with optional tie imprint!

**4-Color Process Print Available!**  
See Page 48

Large Yet Compact!

# The Vented Grand Practicality Folding Umbrella

SB-1310 (Formerly Item# 488FGR-V)

- Automatic opening
- Extra-strong six-sided chrome shaft
- Rubberized black handle with wrist strap
- Matching fabric case

Arc: 46"      Number Of Panels: 8  
 Diameter: 41"      Length When Closed: 17"  
 Opening: Automatic      Imprint Area: 5"H x 8"W

Shipping weight 36 pieces: 34 Lbs. Box Dimensions: 18" x 10" x 12"

12	24	48	96	240	480	1008
19.48	14.48	13.98	13.28	12.48	11.58	10.78 (C)



**Price includes:** 1-Color, 1-Location imprint  
**Extra print(s):** \$1.25 (G) per color, per location  
**Undercanopy printing:** \$2.00 (G) plus setup  
**Case printing:** \$2.00 (G) plus setup  
**Wide Tie printing:** \$2.00 (G) plus setup  
**Setup:** \$65.00 (G) per color, per design  
**Process Color printing:** See page 48  
**Delivery:** 5-7 working days from all approvals

Prices and specifications are subject to change. Refer to [www.strombergbrand.com](http://www.strombergbrand.com) for the most up-to-date information.



Be Safe,  
Be Noticed!



**4-Color Process Print Available!**  
See Page 48

Windproof Frame!

## The Vented Lifesaver Folding Umbrella

SB-4120 (Formerly Item# 107LIF-V)

- Automatic opening
- Full 1" reflective strip on all 8 panels
- Sturdy metal shaft and ribs
- Rubberized black handle with wrist strap and color-matching pushbutton
- Matching fabric case with reflective strip

Arc: 42"      Number Of Panels: 8  
Diameter: 38"      Length When Closed: 15"  
Opening: Automatic      Imprint Area: 5"H x 7"W

Shipping weight 48 pieces: 38 Lbs. Box Dimensions: 16" x 12" x 15"

12	24	48	96	240	480	1008
18.98	13.68	13.28	12.88	12.48	12.08	11.68 (C)



**Price includes:** 1-Color, 1-Location imprint  
**Extra print(s):** \$1.25 (G) per color, per location  
**Undercanopy printing:** \$2.00 (G) plus setup  
**Case printing:** \$2.00 (G) plus setup  
**Wide Tie printing:** \$2.00 (G) plus setup  
**Setup:** \$65.00 (G) per color, per design  
**Process Color printing:** See page 48  
**Delivery:** 5-7 working days from all approvals

Prices and specifications are subject to change. Refer to [www.strombergbrand.com](http://www.strombergbrand.com) for the most up-to-date information.

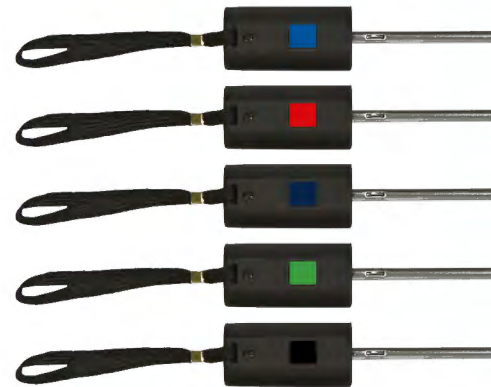

Shown with optional case imprint!





Square Wind Vent



4-Color Process Print Available!

See Page 48

Folds To Just 1 1/2"!

# The Vented Mighty Mite Folding Umbrella

SB-1650 (Formerly Item# 97A0C-V)

- Automatic opening and closing
- Deluxe metal frame construction with hexagonal chrome shaft
- Matching rubberized handle with metal accents and wrist strap
- Matching fabric case

12	24	48	96	240	480	1008
21.48	16.48	15.98	15.38	14.48	13.68	12.88 (C)



Arc: 42"      Number Of Panels: 8  
 Diameter: 38"      Length When Closed: 11"  
 Opening: Automatic      Imprint Area: 4"H x 7"W

Shipping weight 36 pieces: 29 Lbs. Box Dimensions: 13" x 13" x 13"

**Price includes:** 1-Color, 1-Location imprint  
**Extra print(s):** \$1.25 (G) per color, per location  
**Undercanopy printing:** \$2.00 (G) plus setup  
**Case printing:** \$2.00 (G) plus setup  
**Wide Tie printing:** \$2.00 (G) plus setup  
**Setup:** \$65.00 (G) per color, per design  
**Process Color printing:** See page 48  
**Delivery:** 5-7 working days from all approvals

Prices and specifications are subject to change. Refer to [www.strombergbrand.com](http://www.strombergbrand.com) for the most up-to-date information.



Shown with optional tie imprint!





  
**4-Color Process Print Available!**  
 See Page 48

# The Vented Little Giant Folding Umbrella

SB-1700 (Formerly Item# 58EZF-V)

- Automatic opening
- Extra strong six-sided chrome shaft
- Fiberglass ribs
- Wooden handle with corded wrist strap; ready for engraving logos, initials, or names
- Matching fabric case with shoulder strap

**Arc:** 58"      **Number Of Panels:** 8  
**Diameter:** 50"      **Length When Closed:** 22"  
**Opening:** Automatic      **Imprint Area:** 6"H x 9"W  
 Shipping weight 24 pieces: 31 Lbs. Box Dimensions: 22" x 8" x 12"

**Price includes:** 1-Color, 1-Location imprint  
**Extra print(s):** \$1.25 (G) per color, per location  
**Undercanopy printing:** \$2.00 (G) plus setup  
**Case printing:** \$2.00 (G) plus setup  
**Wide Tie printing:** \$2.00 (G) plus setup  
**Setup:** \$65.00 (G) per color, per design  
**Process Color printing:** See page 48  
**Delivery:** 5-7 working days from all approvals

12	24	48	96	240	480	1008
22.28	17.28	16.88	16.18	15.28	14.48	13.68 (C)



Click here to view this umbrella in action on YouTube!



Shown with optional case imprint!

**Laser the Handle!**

See page 48 for more details



58"  
ARC

Wind Vent



4-Color Process Print  
Available!  
See Page 48

**NEW!**

Luxurious New  
Heather Fabric!

# The Vented Heather Little Giant Folding Umbrella

SB-1702

- Automatic opening
- Sophisticated heathered fabric pattern
- Extra strong six-sided chrome shaft
- Fiberglass ribs
- Black foam handle with wrist strap
- Matching fabric case with shoulder strap

12	24	48	96	240	480	1008
25.98	20.98	20.18	19.38	18.58	17.78	16.98 (C)



Navy Blue  
Heather



Gray  
Heather

Arc: 58"      Number Of Panels: 8  
Diameter: 50"      Length When Closed: 22"  
Opening: Automatic      Imprint Area: 6"H x 9"W  
Shipping weight 24 pieces: 31 Lbs. Box Dimensions: 22" x 8" x 12"



Shown with optional  
case and tie imprints!

Price includes: 1-Color, 1-Location imprint  
Extra print(s): \$1.25 (G) per color, per location  
Undercanopy printing: \$2.00 (G) plus setup  
Case printing: \$2.00 (G) plus setup  
Wide Tie printing: \$2.00 (G) plus setup  
Setup: \$65.00 (G) per color, per design  
Process Color printing: See page 48  
Delivery: 5-7 working days from all approvals



Prices and specifications are subject to change.  
Refer to [www.strombergbrand.com](http://www.strombergbrand.com) for the  
most up-to-date information.

42"  
ARC



4-Color Process Print Available!  
See Page 48



Windproof Frame!

# The Vented Color Crown Folding Umbrella

SB-1410 (Formerly Item# 112COL-V)

- Automatic opening
- Windproof frame construction
- Colorful upper vent with contrasting black lower panels
- Extra strong black metal shaft
- Rubberized matching handle with wrist strap
- Matching fabric case

12	24	48	96	240	480	1008
19.98	14.98	14.48	13.78	12.98	12.08	11.28 (C)

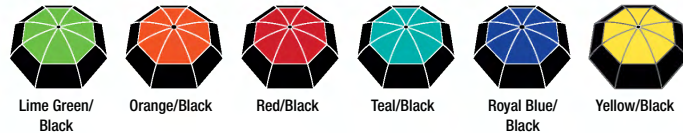

**Price includes:** 1-Color, 1-Location imprint  
**Extra print(s):** \$1.25 (G) per color, per location  
**Undercanopy printing:** \$2.00 (G) plus setup  
**Case printing:** \$2.00 (G) plus setup  
**Wide Tie printing:** \$2.00 (G) plus setup  
**Setup:** \$65.00 (G) per color, per design  
**Process Color printing:** See page 48  
**Delivery:** 5-7 working days from all approvals

Prices and specifications are subject to change. Refer to [www.strombergbrand.com](http://www.strombergbrand.com) for the most up-to-date information.

**Arc:** 42"      **Number Of Panels:** 8  
**Diameter:** 38"      **Length When Closed:** 16"  
**Opening:** Automatic      **Imprint Area:** 5"H x 7"W

Shipping weight 48 pieces: 42 Lbs. Box Dimensions: 16" x 11" x 14"



Shown with optional case imprint!

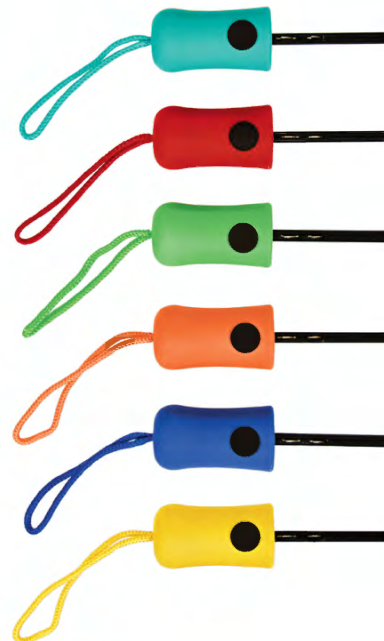



58"  
ARC



# The Vented Colossal Crown Folding Umbrella

SB-1720 (Formerly Item# 130COL-V)

- Automatic opening
- Large colorful upper vent with contrasting black lower panels
- Extra strong black six-sided metal shaft
- Matching foam handle with wrist strap
- Matching fabric case with shoulder strap

**Arc:** 58"      **Number Of Panels:** 8  
**Diameter:** 50"      **Length When Closed:** 22"  
**Opening:** Automatic      **Imprint Area:** 6"H x 9"W

Shipping weight 24 pieces: 31 Lbs. Box Dimensions: 22" x 8" x 11"

12	24	48	96	240	480	1008
22.98	17.98	17.48	16.88	16.08	15.28	14.38 (C)

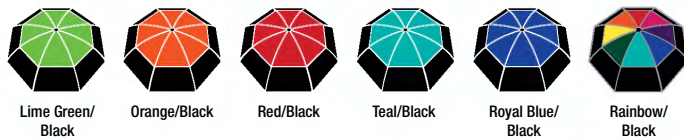

**Price includes:** 1-Color, 1-Location imprint  
**Extra print(s):** \$1.25 (G) per color, per location  
**Undercanopy printing:** \$2.00 (G) plus setup  
**Case printing:** \$2.00 (G) plus setup  
**Wide Tie printing:** \$2.00 (G) plus setup  
**Setup:** \$65.00 (G) per color, per design  
**Process Color printing:** See page 48  
**Delivery:** 5-7 working days from all approvals

Prices and specifications are subject to change.  
 Refer to [www.strombergbrand.com](http://www.strombergbrand.com) for the most up-to-date information.



Shown with optional case imprint!



Shown with optional tie imprint!

**46"**  
ARC

Square  
Wind Vent



**4-Color Process Print Available!**  
See Page 48

## The Vented Director Folding Umbrella

SB-1670 (Formerly Item# 115DIR-V)

- Automatic opening and closing
- Deluxe black metal frame construction
- Hexagonal black shaft
- Black rubberized handle with wood-tone trim and webbed nylon wrist strap
- Matching fabric case with zipper

**Arc:** 46"      **Number Of Panels:** 8  
**Diameter:** 41"      **Length When Closed:** 15"  
**Opening:** Automatic      **Imprint Area:** 6"H x 7"W

Shipping weight 36 pieces: 35 Lbs. Box Dimensions: 13" x 13" x 13"

12	24	48	96	240	480	1008
23.98	18.98	18.58	17.88	17.08	16.28	15.38 (C)



**Price includes:** 1-Color, 1-Location imprint  
**Extra print(s):** \$1.25 (G) per color, per location  
**Undercanopy printing:** \$2.00 (G) plus setup  
**Case printing:** \$2.00 (G) plus setup  
**Wide Tie printing:** \$2.00 (G) plus setup  
**Setup:** \$65.00 (G) per color, per design  
**Process Color printing:** See page 48  
**Delivery:** 5-7 working days from all approvals

Prices and specifications are subject to change.  
Refer to [www.strombergbrand.com](http://www.strombergbrand.com) for the most up-to-date information.



Windproof Frame!



**4-Color Process Print Available!**  
See Page 48



Shown with optional case imprint!

**Final closeout pricing — available only while supplies last!**

12	24	48	96	240	480	1008
<del>22.98</del>	<del>17.48</del>	<del>16.68</del>	<del>15.88</del>	<del>15.08</del>	<del>14.28</del>	<del>13.48</del> (C)
15.98	10.98	10.98	10.98	10.98	10.98	10.98 (C)

## The Super Mini Folding Umbrella

SB-1640

- Automatic opening and closing
- Folds to only 8.5" long
- Compact construction; 4-step metal shaft
- Rubberized black handle with wrist strap
- Matching fabric case with drawstring



**Arc:** 40"      **Number Of Panels:** 6  
**Diameter:** 35"      **Length When Closed:** 8.5"  
**Opening:** Automatic      **Imprint Area:** 3"H x 7"W

Shipping weight 48 pieces: 36 Lbs. Box Dimensions: 19" x 10" x 15"

**Price includes:** 1-Color, 1-Location imprint  
**Extra print(s):** \$1.25 (G) per color, per location  
**Undercanopy printing:** \$2.00 (G) plus setup  
**Case printing:** \$2.00 (G) plus setup  
**Wide Tie printing:** \$2.00 (G) plus setup  
**Setup:** \$65.00 (G) per color, per design  
**Process Color printing:** See page 48  
**Delivery:** 5-7 working days from all approvals

Our Smallest Folding Style –  
Just 8.5"  
When Closed!

Prices and specifications are subject to change. Refer to [www.strombergbrand.com](http://www.strombergbrand.com) for the most up-to-date information.

Shown with optional tie imprint!





Compact Folding Design!

# The Color Flip Inverted Folding Umbrella

SB-4675

- Automatic opening and closing
- Opens and closes in reverse fashion, keeping water away from you
- Deluxe black metal shaft and ribs
- Two-tone handle with wrist strap
- Colorful contrasting undercanopy with black outer canopy
- Matching two-tone fabric case

Arc: 46"      Number Of Panels: 8  
 Diameter: 41"      Length When Closed: 13"  
 Opening: Automatic      Imprint Area: 6"H x 7"W

Shipping weight 36 pieces: 37 Lbs. Box Dimensions: 14" x 13" x 13"



Shown with optional tie imprint!

12	24	48	96	240	480	1008
24.48	19.48	18.98	18.48	17.58	16.78	15.98 (C)



**Price includes:** 1-Color, 1-Location imprint  
**Extra print(s):** \$1.25 (G) per color, per location  
**Undercanopy printing:** \$2.00 (G) plus setup  
**Case printing:** \$2.00 (G) plus setup  
**Wide Tie printing:** \$2.00 (G) plus setup  
**Setup:** \$65.00 (G) per color, per design  
**Delivery:** 5-7 working days from all approvals

Prices and specifications are subject to change. Refer to [www.strombergbrand.com](http://www.strombergbrand.com) for the most up-to-date information.



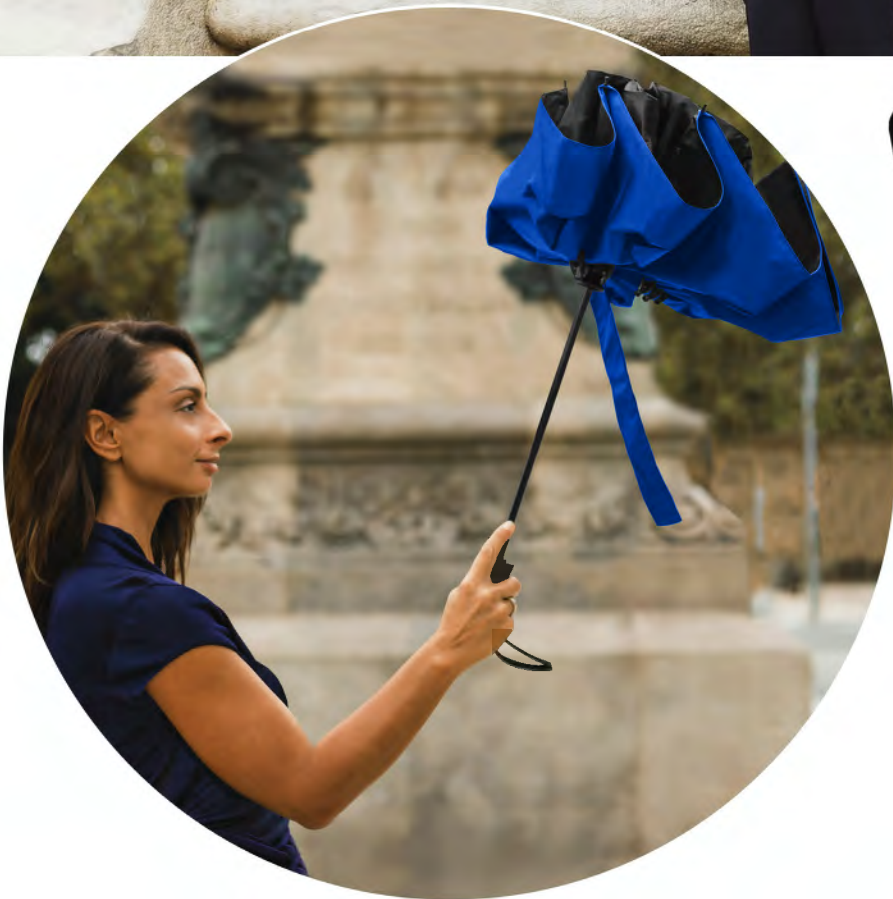

Shown with optional wide tie imprint!



**Compact Folding Design!**



**46"**  
ARC

## The SkyView Inverted Folding Umbrella

SB-4676

- Automatic opening and closing
- Opens and closes in reverse fashion, keeping water away from you
- Deluxe black metal shaft and ribs
- Two-tone handle with wrist strap
- Matching black fabric case

12	24	48	96	240	480	1008
24.98	19.98	19.48	18.98	18.08	17.28	16.48 (C)

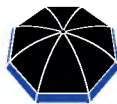

Black/Sky

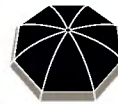

Black/Leopard

**Arc:** 46"      **Number Of Panels:** 8  
**Diameter:** 41"      **Length When Closed:** 13"  
**Opening:** Automatic      **Imprint Area:** 6"H x 7"W

Shipping weight 36 pieces: 37 Lbs. Box Dimensions: 14" x 13" x 13"

## The Leopard Inverted Folding Umbrella

SB-4677

*Same great features and pricing as the SB-4676, with stunning leopard pattern underneath!*



**46"**  
ARC



Reverse Opening  
And Closing  
Keeps Water Away  
From You!

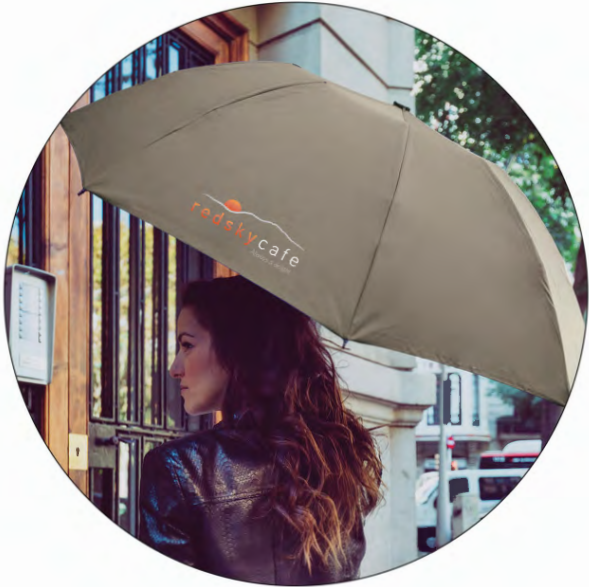

4-Color Process Print  
Available!

See Page 48

Click here to view  
this umbrella in action  
on YouTube!



Compact Folding  
Design!

# The Reversa Inverted Folding Umbrella

SB-4650

- Automatic opening and closing
- Opens and closes in reverse fashion, keeping water away from you
- Deluxe black metal shaft and ribs
- Two-tone handle with wrist strap
- Matching fabric case

12	24	48	96	240	480	1008
22.98	17.98	17.48	16.88	16.08	15.28	14.38 (C)

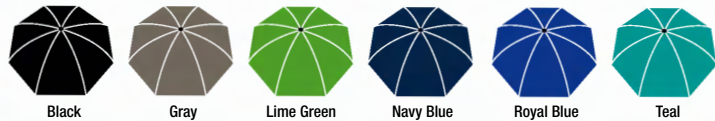

**Price includes:** 1-Color, 1-Location imprint  
**Extra print(s):** \$1.25 (G) per color, per location  
**Undercanopy printing:** \$2.00 (G) plus setup  
**Case printing:** \$2.00 (G) plus setup  
**Wide Tie printing:** \$2.00 (G) plus setup  
**Setup:** \$65.00 (G) per color, per design  
**Process Color printing:** See page 48  
**Delivery:** 5-7 working days from all approvals

Arc: 46"      Number Of Panels: 8  
 Diameter: 41"      Length When Closed: 13"  
 Opening: Automatic      Imprint Area: 6"H x 7"W

Shipping weight 36 pieces: 32 Lbs. Box Dimensions: 14" x 13" x 13"

Prices and specifications are subject to change.  
 Refer to [www.strombergbrand.com](http://www.strombergbrand.com) for the most up-to-date information.



Shown with optional case imprint!





Smartphone-Friendly Handle Design!



4-Color Process Print Available!  
See Page 48

# The ViceVersa Inverted Umbrella

SB-4620

- Manual opening
- Opens and closes in reverse fashion, keeping water away from you
- Black C-shaped handle with color-matching manual-open button
- Gray undercanopy and vibrant outer canopy
- Fiberglass ribs and grooved black shaft
- Does not include a fabric case

12	24	48	96	240	480	1008
23.98	18.98	18.18	17.38	16.58	15.78	14.98 (C)

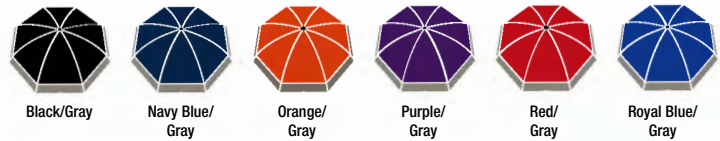

**Price includes:** 1-Color, 1-Location imprint  
**Extra print(s):** \$1.25 (G) per color, per location  
**Undercanopy printing:** \$2.00 (G) plus setup  
**Wide Tie printing:** \$2.00 (G) plus setup  
**Setup:** \$65.00 (G) per color, per design  
**Process Color printing:** See page 48  
**Delivery:** 5-7 working days from all approvals

Prices and specifications are subject to change. Refer to [www.strombergbrand.com](http://www.strombergbrand.com) for the most up-to-date information.

**Arc:** 46"      **Number Of Panels:** 8  
**Diameter:** 38"      **Length When Closed:** 30"  
**Opening:** Manual      **Imprint Area:** 6"H x 7"W

Shipping weight 24 pieces: 31 Lbs. Box Dimensions: 32" x 12" x 8"



Click here to view this umbrella in action on YouTube!







Opens and Closes  
In Reverse!

## The Leopard ViceVersa Inverted Umbrella

SB-4621

Same great features as the SB-4620, with  
stunning leopard pattern underneath!

12	24	48	96	240	480	1008
24.98	19.98	19.18	18.38	17.58	16.78	15.98 (C)

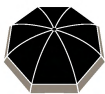

Black/  
Leopard



Opens and Closes  
In Reverse!



  
**4-Color Process Print  
Available!**  
See Page 48



Automatic  
Opening!

# The Inversa Inverted Umbrella

SB-4600

- Automatic opening
- Opens and closes in reverse fashion, keeping water away from you
- Piping and auto-open button match inside undercanopy color
- Fiberglass construction and black metal shaft
- Rubberized handle
- Matching fabric case with shoulder strap

**Arc:** 48"      **Number Of Panels:** 8  
**Diameter:** 41"      **Length When Closed:** 31"  
**Opening:** Automatic      **Imprint Area:** 7"H x 7"W

Shipping weight 24 pieces: 38 Lbs. Box Dimensions: 32" x 12" x 8"

12	24	48	96	240	480	1008
26.98	21.98	21.18	20.38	19.58	18.78	17.98 (C)



**Price includes:** 1-Color, 1-Location imprint  
**Extra print(s):** \$1.25 (G) per color, per location  
**Undercanopy printing:** \$2.00 (G) plus setup  
**Case printing:** \$2.00 (G) plus setup  
**Wide Tie printing:** \$2.00 (G) plus setup  
**Setup:** \$65.00 (G) per color, per design  
**Process Color printing:** See page 48  
**Delivery:** 5-7 working days from all approvals

Prices and specifications are subject to change.  
Refer to [www.strombergbrand.com](http://www.strombergbrand.com) for the most up-to-date information.



Click here to view  
this umbrella in action  
on YouTube!



4-Color Process Print  
Available!  
See Page 48

**NEW!**

## The Heather Inversa Inverted Umbrella

SB-4602

Same great features as the SB-4600, with a sophisticated heather patterned-fabric underneath!

12	24	48	96	240	480	1008
27.98	22.98	22.18	21.38	20.58	19.78	18.98 (C)

Luxurious New  
Heather Fabric!



Black/  
Navy Blue  
Heather



Black/  
Gray  
Heather



Shown with optional  
tie and case imprints!



48"  
ARC



Bright Blue Skies  
Everywhere  
You Go!



4-Color Process Print  
Available!  
See Page 48

## The Blue Sky & Clouds Inverted Umbrella

SB-4601

- Automatic opening
- Opens and closes in reverse fashion, keeping water away from you
- Piping and auto-open button match inside undercanopy color
- Fiberglass construction and black metal shaft
- Rubberized handle
- Matching fabric case with shoulder strap

Arc: 48"      Number Of Panels: 8  
Diameter: 41"      Length When Closed: 31"  
Opening: Automatic      Imprint Area: 7"H x 7"W

Shipping weight 24 pieces: 38 Lbs. Box Dimensions: 32" x 12" x 8"

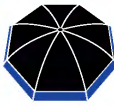

Black/Sky

**Price includes:** 1-Color, 1-Location imprint  
**Extra print(s):** \$1.25 (G) per color, per location  
**Case printing:** \$2.00 (G) plus setup  
**Wide Tie printing:** \$2.00 (G) plus setup  
**Setup:** \$65.00 (G) per color, per design  
**Process Color printing:** See page 48  
**Delivery:** 5-7 working days from all approvals

Prices and specifications are subject to change.  
Refer to [www.strombergbrand.com](http://www.strombergbrand.com) for the most up-to-date information.



Shown with  
optional tie imprint!



58"  
ARC



4-Color Process Print  
Available!  
See Page 48

Our Largest Inverted Style  
Easily Covers Two People!

## The Grand Inversa Inverted Umbrella

SB-4680

- Manual opening
- Opens and closes in reverse fashion, keeping water away from you
- Large golf-size arc provides extra protection against the elements
- Fiberglass construction and black metal shaft
- Rubberized handle
- Matching fabric case with shoulder strap

Arc: 58"      Number Of Panels: 8  
Diameter: 48"      Length When Closed: 36"  
Opening: Manual      Imprint Area: 8"H x 8"W

Shipping weight 24 pieces: 40 Lbs. Box Dimensions: 40" x 8" x 10"

12	24	48	96	240	480	1008
28.98	23.98	23.18	22.38	21.58	20.78	19.98 (C)



Black/Black



Black/Red

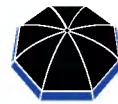

Black/Royal Blue

**Price includes:** 1-Color, 1-Location imprint  
**Extra print(s):** \$1.25 (G) per color, per location  
**Undercanopy printing:** \$2.00 (G) plus setup  
**Case printing:** \$2.00 (G) plus setup  
**Wide Tie printing:** \$2.00 (G) plus setup  
**Setup:** \$65.00 (G) per color, per design  
**Process Color printing:** See page 48  
**Delivery:** 5-7 working days from all approvals

Prices and specifications are subject to change.  
Refer to [www.strombergbrand.com](http://www.strombergbrand.com) for the most up-to-date information.



58"  
ARC



4-Color Process Print Available!  
See Page 48

# The Ultra Value Golf Umbrella

SB-2100 (Formerly Item# 103ST)

- Automatic opening
- Heavy-duty construction; fiberglass ribs
- Extra strong 14mm powder coated black metal shaft
- Comfortable foam two-tone handle
- Doesn't include a fabric case, for extra savings

Arc: 58"      Number Of Panels: 8  
Diameter: 51"      Length When Closed: 38"  
Opening: Automatic      Imprint Area: 8"H x 8"W

Shipping weight 24 pieces: 33 Lbs. Box Dimensions: 40" x 8" x 10"

12	24	48	96	240	480	1008
19.98	15.98	14.88	14.18	13.38	12.48	11.58 (C)

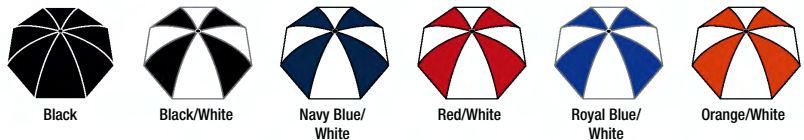

**Price includes:** 1-Color, 1-Location imprint  
**Extra print(s):** \$1.25 (G) per color, per location  
**Undercanopy printing:** \$2.00 (G) plus setup  
**Wide Tie printing:** \$2.00 (G) plus setup  
**Setup:** \$65.00 (G) per color, per design  
**Process Color printing:** See page 48  
**Delivery:** 5-7 working days from all approvals

Prices and specifications are subject to change.  
Refer to [www.strombergbrand.com](http://www.strombergbrand.com) for the most up-to-date information.



Shown with optional tie imprint!





**4-Color Process Print Available!**  
See Page 48

## The Vented Club Canopy Golf Umbrella

SB-2120 (Formerly Item# 106ST-V)

- Automatic opening
- Heavy-duty construction; fiberglass ribs
- Extra strong 14mm powder coated black metal shaft
- Comfortable black foam handle
- Matching fabric case with shoulder strap

**Arc:** 58"      **Number Of Panels:** 8  
**Diameter:** 50"      **Length When Closed:** 38"  
**Opening:** Automatic      **Imprint Area:** 8"H x 8"W

Shipping weight 24 pieces: 34 Lbs. Box Dimensions: 40" x 8" x 10"

12	24	48	96	240	480	1008
21.98	17.98	16.88	16.18	15.38	14.48	13.58 (C)



**Price includes:** 1-Color, 1-Location imprint  
**Extra print(s):** \$1.25 (G) per color, per location  
**Undercanopy printing:** \$2.00 (G) plus setup  
**Case printing:** \$2.00 (G) plus setup  
**Wide Tie printing:** \$2.00 (G) plus setup  
**Setup:** \$65.00 (G) per color, per design  
**Process Color printing:** See page 48  
**Delivery:** 5-7 working days from all approvals

Prices and specifications are subject to change. Refer to [www.strombergbrand.com](http://www.strombergbrand.com) for the most up-to-date information.

Click here to view this umbrella in action on YouTube!





4-Color Process Print Available!  
See Page 48

# The Hole-In-One Golf Umbrella

SB-2200 (Formerly Item# 62AFG)

- Manual opening
- All-fiberglass construction
- Extra-thick 14mm fiberglass black shaft
- Wooden handle ready for engraving logos, initials, or names
- Matching fabric case with shoulder strap

**Arc:** 62"      **Number Of Panels:** 8  
**Diameter:** 51"      **Length When Closed:** 39"  
**Opening:** Manual      **Imprint Area:** 8"H x 9"W

Shipping weight 24 pieces: 31 Lbs. Box Dimensions: 40" x 7" x 9"

**Price includes:** 1-Color, 1-Location imprint  
**Extra print(s):** \$1.25 (G) per color, per location  
**Undercanopy printing:** \$2.00 (G) plus setup  
**Case printing:** \$2.00 (G) plus setup  
**Wide Tie printing:** \$2.00 (G) plus setup  
**Setup:** \$65.00 (G) per color, per design  
**Process Color printing:** See page 48  
**Delivery:** 5-7 working days from all approvals

12	24	48	96	240	480	1008
22.48	18.48	17.38	16.68	15.88	14.98	13.98 (C)



Laser the Handle!



See page 48 for more details



62"  
ARC



  
4-Color Process Print  
Available!  
See Page 48

# The Vented Checkerboard Golf Umbrella

SB-2400

- Automatic opening
- All-fiberglass construction
- Extra rib support with deluxe runner adds strength and durability
- Alternating panel and vent colors
- Color-coordinated two-tone sure-grip handle
- Matching fabric case with shoulder strap

Arc: 62"      Number Of Panels: 8  
Diameter: 51"      Length When Closed: 39"  
Opening: Automatic      Imprint Area: 8"H x 8"W

Shipping weight 24 pieces: 38 Lbs. Box Dimensions: 40" x 7" x 10"

12	24	48	96	240	480	1008
24.98	20.98	19.88	19.18	18.38	17.48	16.58 (C)



**Price includes:** 1-Color, 1-Location imprint  
**Extra print(s):** \$1.25 (G) per color, per location  
**Undercanopy printing:** \$2.00 (G) plus setup  
**Case printing:** \$2.00 (G) plus setup  
**Wide Tie printing:** \$2.00 (G) plus setup  
**Setup:** \$65.00 (G) per color, per design  
**Process Color printing:** See page 48  
**Delivery:** 5-7 working days from all approvals

Prices and specifications are subject to change.  
 Refer to [www.strombergbrand.com](http://www.strombergbrand.com) for the most up-to-date information.



Shown with optional case imprint!



**62"**  
ARC

Tame the Weather!

**4-Color Process Print Available!**  
See Page 48

# The Vented Typhoon Tamer Golf Umbrella

SB-2320 (Formerly Item# TT30-V)

- Manual opening
- All-fiberglass construction including shaft, ribs, tips, and ferrule
- Color-coordinated sure-grip handle
- Matching fabric case with shoulder strap

**Arc:** 62"      **Number Of Panels:** 8  
**Diameter:** 51"      **Length When Closed:** 39"  
**Opening:** Manual      **Imprint Area:** 8"H x 8"W

Shipping weight 24 pieces: 34 Lbs. Box Dimensions: 40" x 7" x 10"

**Price includes:** 1-Color, 1-Location imprint  
**Extra print(s):** \$1.25 (G) per color, per location  
**Undercanopy printing:** \$2.00 (G) plus setup  
**Case printing:** \$2.00 (G) plus setup  
**Wide Tie printing:** \$2.00 (G) plus setup  
**Setup:** \$65.00 (G) per color, per design  
**Process Color printing:** See page 48  
**Delivery:** 5-7 working days from all approvals

12	24	48	96	240	480	1008	(C)
23.98	19.98	18.88	18.18	17.38	16.48	15.58	

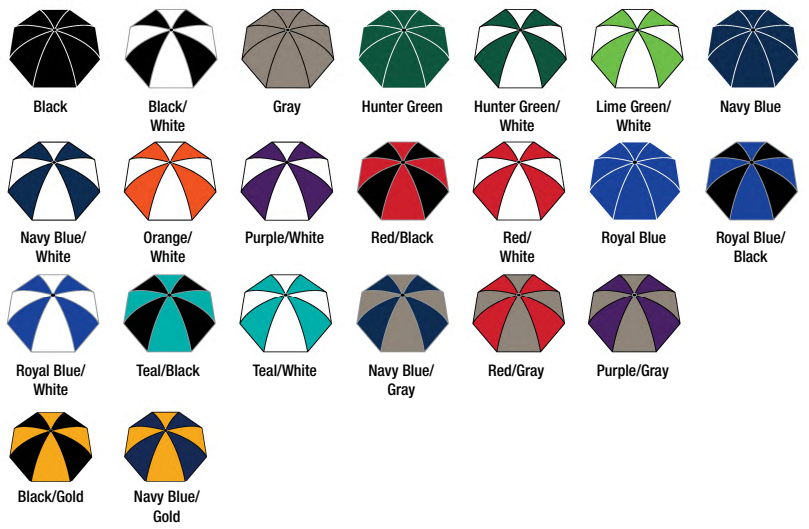

Shown with optional case imprint!



# The Typhoon Tamer and Our Other Golf Umbrellas Make a Big Impact!



**Great for  
on the  
course or  
on the go!**

SB-2320  
shown here

Click here to view  
this umbrella in action  
on YouTube!

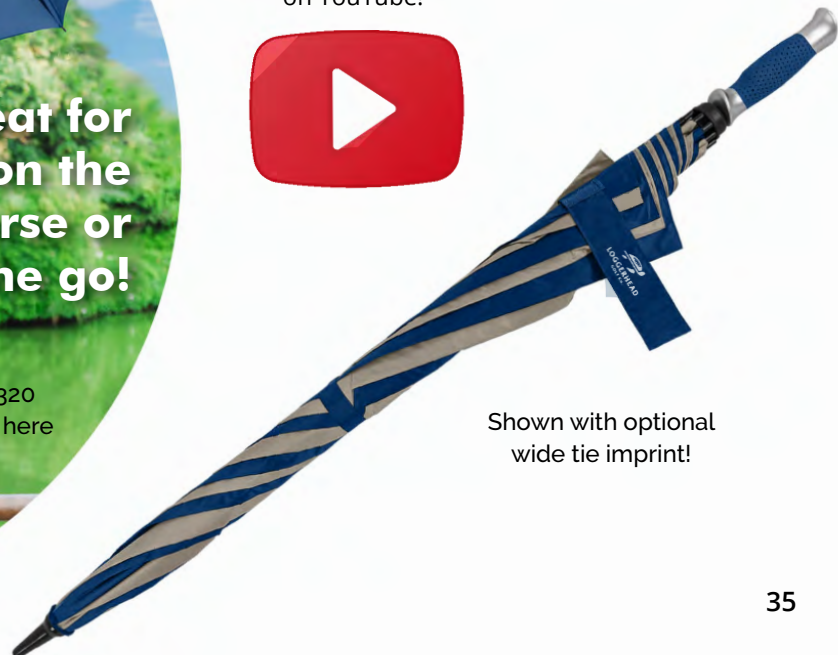

Shown with optional  
wide tie imprint!

64"  
ARC



Extra-Large Arc Size!

# The Vented Tornado Golf Umbrella

SB-2500 (Formerly Item# 83TOR-V)

- Automatic opening
- All-fiberglass construction includes extra-thick ribs, shaft, and ferrule
- Heavy-duty balanced frame construction
- Black molded rubber sure-grip handle
- Matching fabric case with shoulder strap

**Arc:** 64"      **Number Of Panels:** 8  
**Diameter:** 54"      **Length When Closed:** 41"  
**Opening:** Automatic      **Imprint Area:** 8"H x 10"W

Shipping weight 24 pieces: 44 Lbs. Box Dimensions: 41" x 8" x 10"

Shown with optional case imprint!



12	24	48	96	240	480	1008
27.98	23.98	22.88	22.18	21.38	20.48	19.78 (C)



**Price includes:** 1-Color, 1-Location imprint  
**Extra print(s):** \$1.25 (G) per color, per location  
**Undercanopy printing:** \$2.00 (G) plus setup  
**Case printing:** \$2.00 (G) plus setup  
**Wide Tie printing:** \$2.00 (G) plus setup  
**Setup:** \$65.00 (G) per color, per design  
**Process Color printing:** See page 48  
**Delivery:** 5-7 working days from all approvals

Prices and specifications are subject to change. Refer to [www.strombergbrand.com](http://www.strombergbrand.com) for the most up-to-date information.





All Components  
Color-Coordinated!

  
4-Color Process Print  
Available!  
See Page 48

## The Vented Paramount Golf Umbrella

SB-2450 (Formerly Item# 119PAR-V)

- Automatic opening
- Heavy-duty balanced frame construction
- All-fiberglass construction including shaft, ribs, tips, and ferrule; all color-coordinated
- Matching rubberized sure grip handle
- Matching fabric case with shoulder strap

Arc: 64"      Number Of Panels: 8  
Diameter: 54"      Length When Closed: 41"  
Opening: Automatic      Imprint Area: 8"H x 10"W

Shipping weight 24 pieces: 47 Lbs. Box Dimensions: 41" x 8" x 10"

12	24	48	96	240	480	1008
28.98	24.98	23.88	23.18	22.38	21.48	20.58 (C)

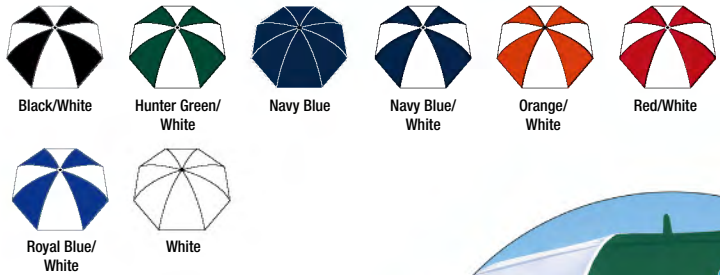

**Price includes:** 1-Color, 1-Location imprint  
**Extra print(s):** \$1.25 (G) per color, per location  
**Undercanopy printing:** \$2.00 (G) plus setup  
**Case printing:** \$2.00 (G) plus setup  
**Wide Tie printing:** \$2.00 (G) plus setup  
**Setup:** \$65.00 (G) per color, per design  
**Process Color printing:** See page 48  
**Delivery:** 5-7 working days from all approvals

Prices and specifications are subject to change.  
Refer to [www.strombergbrand.com](http://www.strombergbrand.com) for the most up-to-date information.



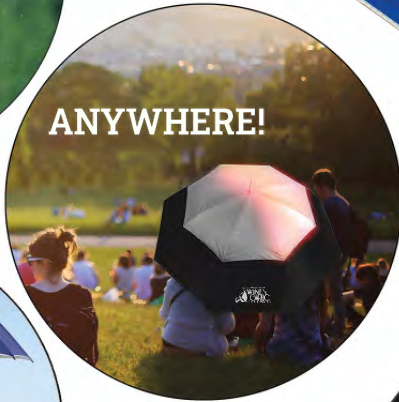

Pointed extension pole included



**4-Color Process Print Available!**  
See Page 48

## The Sport Utility Umbrella!

# The Vented UV Golf/Beach Umbrella

SB-2700 (Formerly Item# 108UVB-V)

- Manual opening
- Multi-purpose Golf/Beach umbrella
- Custom 2 ply laminated canopy is rated SPF 50
- Blocks 99.9% of the sun's harmful UV rays
- All-fiberglass construction
- Extra thick 14mm black shaft for extra strength
- Pointed beach extension pole included
- Black hard rubber sure-grip handle
- Matching metallic case with shoulder strap

**Arc:** 62"      **Number Of Panels:** 8  
**Diameter:** 51"      **Length When Closed:** 41"  
**Opening:** Manual      **Imprint Area:** 8"H x 9"W

Shipping weight 24 pieces: 43 Lbs. Box Dimensions: 41" x 9" x 10"

12	24	48	96	240	480	1008
33.98	29.98	28.78	27.58	26.98	26.38	25.98 (C)



**Price includes:** 1-Color, 1-Location imprint  
**Extra print(s):** \$1.25 (G) per color, per location  
**Undercanopy printing:** \$2.00 (G) plus setup  
**Setup:** \$65.00 (G) per color, per design  
**Process Color printing:** See page 48  
**Delivery:** 5-7 working days from all approvals

Prices and specifications are subject to change.  
 Refer to [www.strombergbrand.com](http://www.strombergbrand.com) for the most up-to-date information.

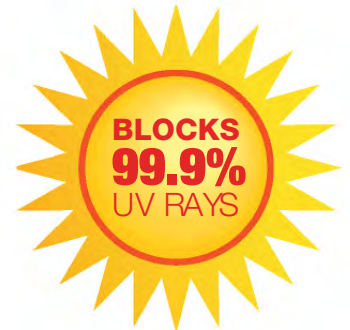

48'  
ARC



4-Color Process Print  
Available!  
See Page 48

## The City Slicker Classic Stick Umbrella

SB-3200

- Automatic opening
- Metal-tipped fiberglass ribs
- Extra-thick black metal central shaft
- Black fiberglass ferrule
- Comfortable black foam handle
- Matching fabric case with shoulder strap

Arc: 48"      Number Of Panels: 8  
Diameter: 41"      Length When Closed: 32"  
Opening: Automatic      Imprint Area: 6"H x 7"W

Shipping weight 36 pieces: 32 Lbs. Box Dimensions: 34" x 7" x 10"

12	24	48	96	240	480	1008
17.98	12.98	12.18	11.38	10.58	9.78	8.98 (C)



**Price includes:** 1-Color, 1-Location imprint  
**Extra print(s):** \$1.25 (G) per color, per location  
**Undercanopy printing:** \$2.00 (G) plus setup  
**Case printing:** \$2.00 (G) plus setup  
**Wide Tie printing:** \$2.00 (G) plus setup  
**Setup:** \$65.00 (G) per color, per design  
**Process Color printing:** See page 48  
**Delivery:** 5-7 working days from all approvals

Prices and specifications are subject to change.  
 Refer to [www.strombergbrand.com](http://www.strombergbrand.com) for the most up-to-date information.

A Modern  
Take On A  
Classic Style!

Shown with  
optional case imprint!





**4-Color Process Print Available!**  
See Page 48

# The Continental Fashion Umbrella

SB-3150

- **Automatic opening**
- Fiberglass frame and gunmetal-tipped ribs
- Colored stripes add flair to canopy and handle
- Extra thick black metal shaft
- Curved 25 mm J-shape rubberized handle
- Matching fabric case with shoulder strap

**Arc:** 48"      **Number Of Panels:** 8  
**Diameter:** 44"      **Length When Closed:** 33"  
**Opening:** Automatic      **Imprint Area:** 6"H x 6"W  
 Shipping weight 36 pieces: 36 Lbs. Box Dimensions: 34" x 7" x 10"

**Final closeout price — available only while supplies last!**

12	24	48	96	240	480	1008
<del>20.98</del>	<del>15.98</del>	<del>15.18</del>	<del>14.38</del>	<del>13.58</del>	<del>12.78</del>	<del>11.98</del> (C)
12.98	9.48	9.48	9.48	9.48	9.48	9.48 (C)

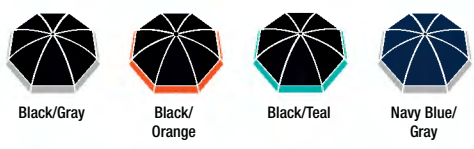

**Price includes:** 1-Color, 1-Location imprint  
**Extra print(s):** \$1.25 (G) per color, per location  
**Undercanopy printing:** \$2.00 (G) plus setup  
**Case printing:** \$2.00 (G) plus setup  
**Wide Tie printing:** \$2.00 (G) plus setup  
**Setup:** \$65.00 (G) per color, per design  
**Process Color printing:** See page 48  
**Delivery:** 5-7 working days from all approvals

Prices and specifications are subject to change.  
 Refer to [www.strombergbrand.com](http://www.strombergbrand.com) for the most up-to-date information.

Shown with optional tie imprint!





48"  
ARC



4-Color Process Print  
Available!  
See Page 48

# The Vented Urban Brolly Fashion Umbrella

SB-3120 (Formerly Item# 24WS0-V)

- Automatic opening
- Fiberglass ribs and support arms
- 14mm kiln-dried Maple wood central shaft
- Deluxe curved wood handle
- Matching fabric case with shoulder strap

Arc: 48"      Number Of Panels: 8  
Diameter: 41"      Length When Closed: 35"  
Opening: Automatic      Imprint Area: 5"H x 7"W

Shipping weight 36 pieces: 35 Lbs. Box Dimensions: 37" x 12" x 10"

12	24	48	96	240	480	1008
20.98	15.98	15.18	14.38	13.58	12.78	11.98 (C)



Black



Gray



Hunter Green



Navy Blue

**Price includes:** 1-Color, 1-Location imprint  
**Extra print(s):** \$1.25 (G) per color, per location  
**Undercanopy printing:** \$2.00 (G) plus setup  
**Case printing:** \$2.00 (G) plus setup  
**Wide Tie printing:** \$2.00 (G) plus setup  
**Setup:** \$65.00 (G) per color, per design  
**Process Color printing:** See page 48  
**Delivery:** 5-7 working days from all approvals

Prices and specifications are subject to change.  
Refer to [www.strombergbrand.com](http://www.strombergbrand.com) for the most up-to-date information.



Shown with optional case imprint!



Classics Never Go Out of Style!

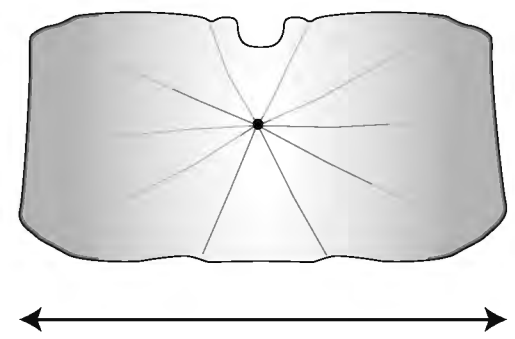

57"W x 36"H



**NEW!**

Blocks 98% of Harmful UV Rays and Keeps Cars Cool!

# The Dashboard Defender Folding Umbrella

SB-7100

- Premium double-sided canopy; black plus a metallic silver UV coating (rated SPF 50)
- Rectangular 57x35" shape fits most windshields.
- Manual opening and closing
- Extra-strong six-sided black metal shaft
- Black matte finish plastic ribbed handle with golden ring accent and 5" wrist strap

12	24	48	96	240	480	1008
26.98	21.98	21.48	20.98	20.48	20.18	19.88 (C)

**Price includes:** 1-Color, 1-Location imprint  
**Extra print(s):** \$1.25 (G) per color, per location  
**Undercanopy printing:** \$2.00 (G) plus setup  
**Case printing:** \$2.00 (G) plus setup  
**Optional gift box:** \$3.50 (C) each  
**Setup:** \$65.00 (G) per color, per design  
**Process Color printing:** See page 48  
**Delivery:** 5-7 working days from all approvals

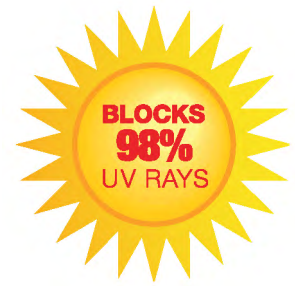

Multi-Purpose for Rain, Shine, or Emergency Usage

Prices and specifications are subject to change. Refer to [www.strombergbrand.com](http://www.strombergbrand.com) for the most up-to-date information.

**Arc:** 57"      **Number Of Panels:** 10  
**Diameter:** 57"      **Length When Closed:** 13"  
**Opening:** Manual      **Imprint Area:** 7-10"H x 5-6"W

Shipping weight 24 pieces: 28 Lbs. Box Dimensions: 14" x 14" x 14"



Deluxe leatherette storage case included. Shown with optional case imprint!

Click here to view this umbrella in action on YouTube!





**BLOCKS  
98%  
UV RAYS**

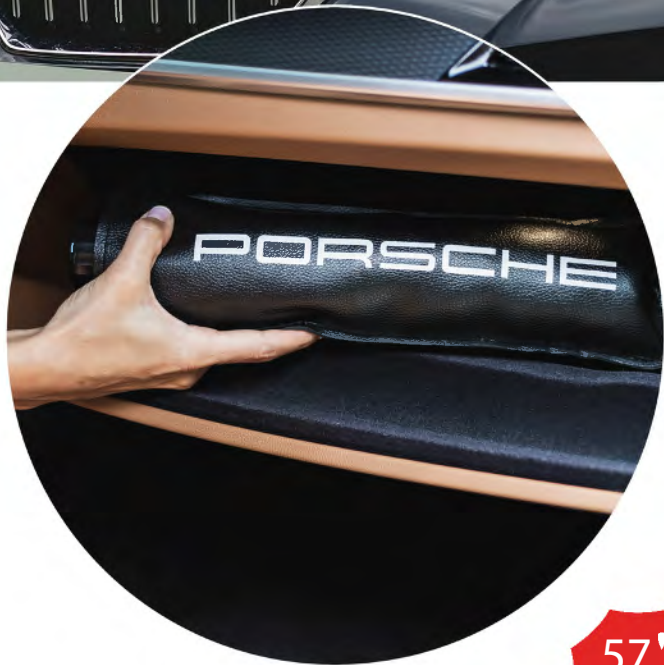

**57"**  
← WIDTH →



Optional gift boxes showcasing features:  
\$3.50(C) each





4-Color Process Print Available!  
See Page 48



84" ARC



### Commercial Quality and ONE-Piece Minimum!

Order a base for each umbrella!



Item SB-g260  
Free-Standing Durable High-Density Textured Plastic Base  
**\$49.98(C)**  
*No Table Needed!*

## The Vented Bistro Patio Umbrella

SB-5500 (Formerly Item# 117BIS-V)

- Manual opening
- Oxford woven fabric: high-density coated 8 oz polyester with 7' (84") arc
- Extra-thick 11 mm fiberglass ribs and support arms
- Three-position tilting canopy
- Safety opening device (runner) protects hands
- Aircraft aluminum 38 mm 8-sided central pole with PATENTED safety latch connector (pole is approx. 7' long when assembled)
- Easily removable canopy for cleaning or storage
- For patio use, requires table and/or base: sold separately (see above)

1	3	6	12	24	48	96
341.98	288.98	183.98	158.98	149.98	146.98	144.98 (C)

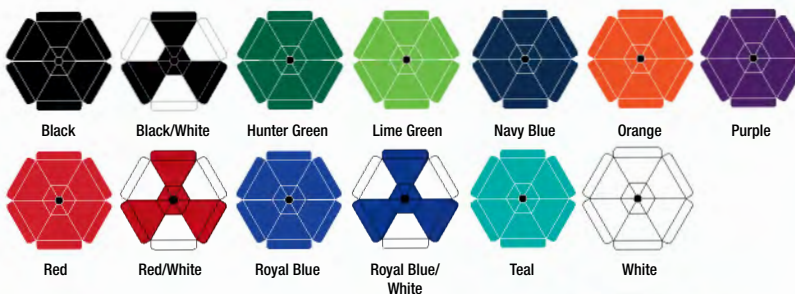

**Price includes:** 1-Color, 1-Location imprint  
**Setup, Panel:** \$130.00 (G) per color, per design  
**Setup, Valance:** \$90.00 (G) per color, per design  
**Extra print(s):** \$4.00 (G) per color, per location  
**Process Color printing:** See page 48  
**Delivery:** 10-12 working days from all approvals

Prices and specifications are subject to change. Refer to [www.strombergbrand.com](http://www.strombergbrand.com) for the most up-to-date information.



**Arc:** 84"      **Number Of Panels:** 6  
**Diameter:** 79"      **Length When Closed:** 53"  
**Opening:** Manual      **Imprint Area:** 5"H x 20"W (Valance)  
                                  **Imprint Area:** 13"H x 20"W (Panel)

Shipping weight 1 piece: 11 Lbs. Box Dimensions: 55" x 5" x 5"

# THE WORLD'S BEST

## Commercial Quality **Patio Umbrella!** Patented Construction



**Extra Thick 10.5mm  
Fiberglass Ribs!**  
10% Stronger than other  
patio umbrellas

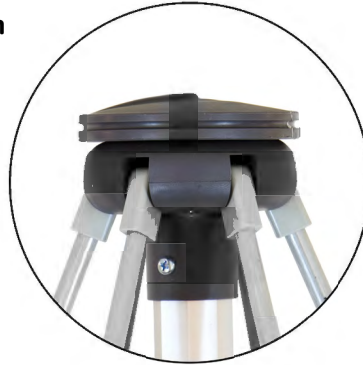

**A**  
**Removable Flat Ferrule!**



**B**  
**3-Position Tilting  
Device!**



**C**  
**Safety Rib Tips**  
Molded tips on rib ends  
prevent canopy from tearing  
at high stress points

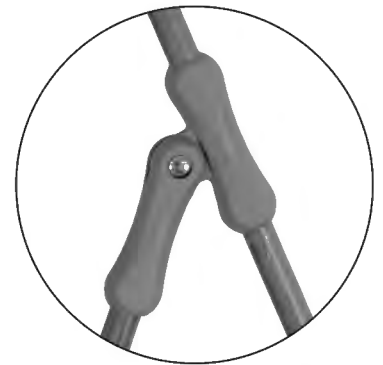

**D**  
**Extra Strong Rib  
Joint**  
Extremely break resistant

**Safety  
Opening  
Device!**



**E**  
**Extra Safe Pole  
Connector**  
Patented lever provides  
added safety

**E**  
**8-Sided Two Piece  
Pole!**

38mm (1.5 in) diameter.  
Fits most tables. Pole finish is an  
**ANODIZED AIRCRAFT ALUMINUM**  
matte finish. Non-corrosive, high  
quality.  
Extra secure pole clamp.

Custom Colors Available! 100 Piece Minimum. Call For Quote.

  
**STROMBERGBRAND®**  
**UMBRELLAS**  
SINCE 1942



**3 Year Guarantee  
Against Fading  
And Mildew!**



## The Vented Ultimate Patio Umbrella

SB-5700

- Manual opening
- 7' (84") arc vented canopy
- Oxford woven fabric: high-density coated 8 oz polyester
- Extra-thick fiberglass ribs and support arms
- Safety opening device (runner) protects hands
- 3-Position tilting canopy
- Aircraft aluminum 38mm (1.5") O.D. 8-sided central pole & PATENTED safety latch connector (pole is approx. 7' long when assembled)
- Easily removable canopy for cleaning or storage
- Bases sold separately (see previous page)

**Arc:** 84"      **Number Of Panels:** 6  
**Diameter:** 79"      **Length When Closed:** 53"  
**Opening:** Manual      **Imprint Area:** 13"H x 20"W (Panel)  
    **Imprint Area:** 5"H x 20"W (Valance)

Shipping weight 1 piece: 11 Lbs. Box Dimensions: 55" x 5" x 5"

1	3	6	12	24	48	96
399.98	349.98	270.98	255.98	240.98	225.98	210.98 (C)



Black



Red

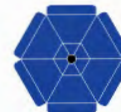

Royal Blue



**4-Color Process Print  
Available!**

See Page 48

**Price includes:** 1-Color, 1-Location imprint  
**Setup, Panel:** \$130.00 (G) per color, per design  
**Setup, Valance:** \$90.00 (G) per color, per design  
**Extra print(s):** \$4.00 (G) per color, per location  
**Process Color printing:** See page 48  
**Delivery:** 10-12 working days from all approvals

Prices and specifications are subject to change.  
 Refer to [www.strombergbrand.com](http://www.strombergbrand.com) for the most up-to-date information.



**Custom Vented Pinwheel Design** *(call for details)*

# Unique Custom Umbrellas

## EXTRA-COMPLEX PROJECTS

Almost anything is possible with colors, shapes, and exotic material to create unique umbrellas. Add a water-resistant speaker to the handle for music on the go via Bluetooth - the options can be endless.

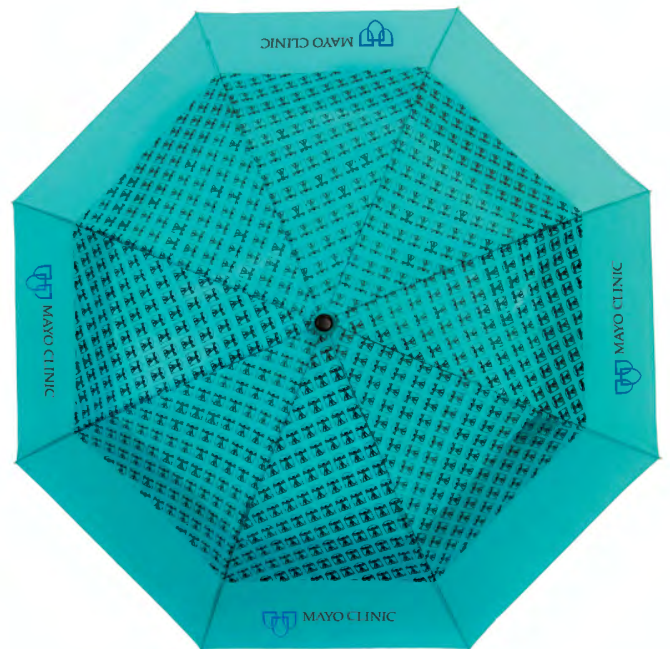

## STEP & REPEAT PATTERNS

We can create fashionable patterns from one or more pieces of art and repeat it in any number of ways.



# 4-Color Process Imprinting

- Any number of colors for the same price
- Printing on any color including black
- Minimum order only 12 pieces
- Low setup and running costs
- Quick turnaround time
- Print on up to 8 panels

## 4-Color Process Imprinting Costs: Per Imprint, Handheld

*\*Add The Process Color Run Charge Below To Any Rain Umbrella In Our Line*

12	24	48	96	240	480	1008
10.50	5.25	3.20	3.00	2.80	2.65	2.25

(G)

## Other Costs & Delivery

**Art Setup:** \$120.00 (G) per design

**Pre-Production Proofs:** \$72.00 (G) plus cost of item & charges (5-7 additional days)

**Reorder Setup:** \$120.00 (G)

**Production Time:** 10-12 business days from all approvals



## 4-Color Process Imprinting Costs: Per Imprint, Patio

*\*Add The Process Color Run Charge Below To Any Patio Umbrella In Our Line*

12	24	48	96	201+
22.50	22.50	22.50	22.50	QUOTE

(G)

## Other Costs & Delivery

**Art Setup, Valance:** \$146.00 (G)

**Art Setup, Panel:** \$296.00 (G)

**Pre-Production Proofs:** \$125.00 (G) plus cost of item & charges (5-7 additional days)

**Reorder Setup:** \$296.00 (G) for panel and/or \$146.00 (G) for valance

**Production Time:** 10-12 business days from all approvals

Visit [www.strombergbrand.com](http://www.strombergbrand.com) for more information, such as imprint size requirements.

## Laser Engraving

- Available on all straight wood handles
- Great personalization options
- Minimum order only 24 pieces
- Quick turnaround time

## Costs & Delivery

**Logo or Company Name:** \$4.00 (G)

**Individual Personalization:** \$5.00 (G)

**Laser Setup:** \$80.00 (G)

**Reorder Laser Setup:** \$40.00 (G)

**Delivery:** 5-7 additional business days





# GENERAL INFORMATION

## Terms Of Sale

### 1. PRICES

F.O.B. factory.

### 2. NEW ACCOUNTS

First-time customers require prepay.

### 3. ESTABLISHED ACCOUNTS

For accounts with pre-approved credit lines we offer a 1% discount for payment made in 10 days, net to be paid promptly in 30 days.

### 4. PRICE CHANGES

All prices are subject to change but orders will not be processed without prior authorization from the customer.

### 5. VOLUME DISCOUNTS

Prices for quantities greater than shown herein shall be quoted on request.

### 6. CO-OP & ONLINE STORE PROGRAMS

A 24 unit minimum order is required for EQP. Proof of co-op is required and the specific terms of the co-op must be approved by us. Please call for details.

### 7. SHIPPING

All shipments are shipped best way unless we are notified to follow specific instructions.

### 8. RETURNS & CLAIMS

Must be reported within 15 working days from receipt of merchandise and must have our RA# prominently displayed. We reserve the right to turn away returns/claims not reported within our time frame.

### 9. LIMITED LIFETIME WARRANTY

We will repair or replace any defective umbrellas returned to us prepaid. This warranty applies to manufacturing defects only. Abuse and misuse are not covered. Warranty returns must have our RA# prominently displayed.

### 10. ORDER COMPLETION

All orders considered complete with +/- 5% overrun or underrun.

### 11. PRODUCTION TIME

Estimated time is quoted from date of order receipt, camera-ready art, approvals, and terms.

### 12. SHIP DATE CHANGES

Any changes to ship date must be made 5 days prior to scheduled ship date.

### 13. CANCELLATIONS/RE STOCKING

15% of order cost. No cancellation on imprinted merchandise.

### 14. DYE LOTS & WOOD TONES

Certain color fabrics may vary from dye lot to dye lot. Wood finish color on handles may vary from lot to lot.

### 15. SAMPLES

Available at EQP plus shipping. For in-stock items only. Send sample requests by e-mail to: [sample@strombergbrand.com](mailto:sample@strombergbrand.com). Requests received by 2 PM will be shipped same day.

## Additional Costs

### 16. PRE-PRODUCTION PROOFS

Applies to screen printing only (no process). Rain Umbrellas: \$38.00(G), Patio Umbrellas \$75.00(G) plus cost of item, run charge(s) and setup(s). Add 2 weeks to normal delivery time.

### 17. ART PROOFS

PDF virtual proof(s) are provided for every order, along with sales order acknowledgment. There is no charge for these initial proofs; multiple requests for proofs/revisions may incur a charge (see below). Virtual proofs are visual approximations; placement of imprint and color(s) may vary from actual printed product. We will size the art by the size(s) listed.

### 18. REORDER SETUP

Art saved for 18 months only. Rain Umbrella: \$32.50(G) each color, each design. Patio Umbrellas: Panel \$95.00(G), Valance \$68.00(G). These prices do not apply to 4-Color Process Printing or Laser Setups.

### 19. DROP SHIPS

\$8.50(G) each. Individual boxing is included.

### 20. SPECIAL PACKAGING OR REQUESTS

Please call us for details if you need special packaging, hang tag removal, case insertion, or other requests not listed on this page. Additional costs may apply.

### 21. UMBRELLA CASE PRINTING

Available on most items with a matching case. Imprint cost is \$2.00(G) plus setup; one color only except on special overseas orders.

### 22. WIDE TIE PRINTING

Available on all items with wide ties. Imprint cost is \$2.00(G) plus setup; one color only except on special overseas orders.

### 23. UNDER CANOPY PRINTING

Printing on the inside of a panel is available at \$2.00(G) per color, per design plus set-up.

### 24. 4-COLOR PROCESS

See previous page for details.

### 25. TYPE SET

\$20.00(G). (Straight line copy only).

### 26. PMS MATCH

\$32.50(G) per color, per design. We will mix inks to achieve closest PMS match. With fabric printing an exact match cannot be 100% guaranteed.

### 27. ART CHARGES

\$60.00(G) per hour. Artwork conversion is \$25.00(G)

### 28. INK CHANGE

\$32.50(G). Minimum quantity is 12 pieces.

## Guide To Umbrella Measurements & Imprinting area

- Arc & Diameter of umbrella are measured in inches
- Logos are printed approximately 1.5" from bottom seam. Imprint width and height vary by umbrella.

## Artwork Requirements

All orders and artwork must be emailed to [order@strombergbrand.com](mailto:order@strombergbrand.com). Your PO number, your company name, and the print-ready vector artwork must be submitted at the same time.

**ELECTRONIC MEDIA:** Is required and should be e-mailed to: [order@strombergbrand.com](mailto:order@strombergbrand.com)

**PC FORMAT:** Adobe Illustrator vector file; convert text to outlines & save as AI, EPS, SVG, or PDF.

**MAC FORMAT:** Convert to Illustrator-compatible file.

**WE DO NOT ACCEPT:** BMP, CDR, DAT, DST, GIF, JPG, JPEG, PNG, SIT, TIFF, DOC, or hard copy art.

## Standard Colors & Sizing Guide

### PMS EQUIVALENTS OF FABRIC COLORS & OUR STANDARD PRINTING COLORS

Approximate equivalents of actual fabric colors to be used as a guide. There is no PMS match charge for these colors.

	<b>Black =</b> PMS Black		<b>White =</b> Pure White
	<b>Orange =</b> PMS 021		<b>Yellow =</b> PMS 106
	<b>Flat Gold =</b> PMS 125		<b>Gold =</b> PMS 130
	<b>Red =</b> PMS 186		<b>Burgundy =</b> PMS 229
	<b>Purple =</b> PMS 2617		<b>Carolina Blue =</b> PMS 277
	<b>Royal =</b> PMS 293		<b>Navy =</b> PMS 295
	<b>Teal Blue =</b> PMS 326		<b>Hunter =</b> PMS 343
	<b>Lime =</b> PMS 360		<b>Brown =</b> PMS 4625
	<b>Khaki =</b> PMS 4515		<b>Gray =</b> PMS 403
	<b>Flat Silver =</b> PMS Cool Gray #5		<b>Graphite Gray =</b> PMS Cool Gray #10

**METALLIC INK:** Standard metallic colors are:

	<b>Gold =</b> PMS 871		<b>Silver =</b> PMS 877
---	--------------------------	---	----------------------------

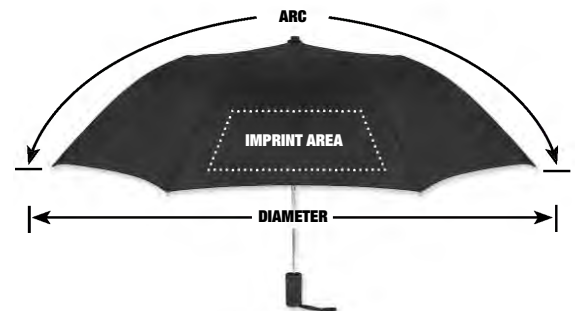



**Taking You Anywhere You Want To Go!**



57801



89955



114212



1ASTRMBG

**STROMBERGBRAND.COM**

