

ASI 73450 / PPAI 112563

NAPTM



World of Colors

2021
CATALOG

IN BUSINESS SINCE
1964

ARTWORK REQUIREMENTS

Programs Supported	Adobe Illustrator CS6 Adobe Photoshop CS6
Files That Require Cleanup Fee	EPS AI TIFF JPG BMP And All Other Bitmap Files
Platforms Supported	PC or MAC
Supported Media	FTP UPLOAD (ftp.napmfg.com) CD Disc DVD Disc

Adobe Illustrator: This is our preferred program. Other non-Adobe Illustrator files will be imported into Adobe Illustrator so please prepare your graphic file(s) accordingly.

Adobe Photoshop: Save file as EPS or as a TIFF with a minimum of 300 DPI resolution. The size should be equal to 1/2 of the actual print size.

File Specs.: Please include all EPS and/or TIFF files, and include fonts or convert fonts to curves or outlines. Also include a printed listing of the file names used in your graphic. We no longer return computer discs, composites, or laser printouts so please DO NOT send in your original copies. Sample items such as banners, flags, pins, buttons and other samples will be returned at distributors expense.

Imprint Colors: When submitting artwork for spot colors please specify a coated PMS number from the Pantone Matching System. If you do not specify a PMS color the factory will use a standard shade of standard color. Not every PMS color shade can be matched 100%. Because of variances in inks, substrates, and printing processes the finished product will not usually match a printed color composite.

E-mail Note: When sending your file via E-mail you must include your distributor name, ASI/PPAI number, contact phone, purchase order number. Maximum email file size is 4 megabytes.

FTP SITE: For large files please be sure to zip or stuff the file(s) before uploading to our ftp site (ftp.napmfg.com) to prevent corruption in the transit. Please include all files used in the artwork including links such as TIFF, EPS, or JPG, and any fonts not converted to vector or curves. All files received will be imported to Illustrator so to prevent corruption please save files in EPS format. Call our customer service for User ID and Password.

MATERIAL COLORS

STANDARD NYLON

OG Red	Emerald Green	Black
Orange	OG Blue	Spice Brown
Spanish Yellow	White	Royal Blue

PREMIUM NYLON

Magenta	FM Yellow	Gold
Canada Red	Mint Green	Lavender
Salmon	Turquoise	French Blue
Crimson	Buff	Dartmouth Green
Wineberry	UN Blue	Burnt Orange
Pansy	Brick Red	Dahlia
Nickel	Rust	Orchid
Charcoal	Crocus	Bell Blue
Maroon	Process Blue	Purple
Gold Brown	Peach	Flesh
Warm Red	Lilac	Amber
Golden Poppy	Aqua	Tan
Ruby	Peacock	Silver

GENERAL INFORMATION

SAMPLE ART: In most cases a flat fee of \$80.00 (net) will be added for artwork taken from sample flags or banners.

ARTWORK CLEANUP: If you provide us with artwork that requires redoing a cleanup charge of \$35.00 (net) per hour will be assessed to order. Examples of artwork requiring cleanup would be JPG's, TIFF's, WMF's, DOC's, PDF's, or samples received such as flags, banners, t-shirts, embroidered patches and like materials.

COLOR MATCHING: Not all imprint colors can be matched 100%. We will do our best to match any PMS color you provide. If no PMS color is provided we will use our standard shades of standard colors.

DELAYS: Order delays can be caused by many things including but not limited to, creating changes in artwork, receiving of poor artwork, or not approving our faxed layout in a timely manner.

DYE-LOTS: Material dye-lots will vary with each run therefor and exact material color match from run to run may not be possible. Because we buy materials from various mills in the U.S. we cannot guarantee that one mill's color will perfectly match another mill's color of the same trade name.

LAYOUTS: We will fax a black and white layout for approval prior to production. If order canceled prior to any actual production a \$35.00 (net) layout fee will be charged.

SUMMARY OF ORDERING POLICY

RETURNS: Please do not return merchandise without prior authorization. If you encounter a problem with your order please call us for instructions. If your product needs to be returned to us we will issue a Return Authorization Number (RMA). Packages received without a valid RMA are subject to be refused at the dock.

CHANGES or CANCELLATIONS: Changes or cancellations to orders in which we have already completed some or all of the components of the job will be billed according to our labor and material cost. Cancellations or changes must be made in writing.

VERBAL QUOTES: The factory will provide you with a written estimate for any project you have. In most cases you can find your price right in our catalog, however, variations of products listed herein are subject to quote. The factory reserves the right to reject any and all price quotes made verbally. For this reason we encourage our distributors to ask for a written estimate at all times.

PRODUCT SIZES: Unless specifically noted in the product description all sizes listed in catalog are before sewing. Please consider this when ordering products with sleeves. Finished size products (after sewing) are subject to quote.

MATERIAL DEFECTS: In the rare occasion you receive a product with a manufacturer's defect we will be happy to repair the product or pro-rate the replacement. If you feel you have a product with a manufacturer's defect please call us for instructions.

TERMS: All new customers will automatically have terms of C.O.D. until credit has been approved by our credit department. Your shipment will arrive via UPS C.O.D. Cashier's Check. Orders can also be pre-paid with any major credit card. C.O.D. Company Check requires pre-approval from our credit department. Some orders may require a deposit. Cannot drop ship CODs.

CATALOG INDEX

AUTOMOTIVE

3'x5' Message Flags	22-27
3'x8' Pole Banners (for universal brackets)	29-30
3'x5' Three Flag Cluster Flag Kits	22
3'x5' Three Stripe Message Flags	23
3'x8' Three Stripe Vertical Message Flags	25
3'x5' Three Stripe Dealership Flags	23
12"x18" Dealership Pennant Strings/Message	31
3'X5' Dealer Flag Logo Flags	22
3'x5' Petroleum & Fast Food Identity Flags	22
3'x5' Checkered Flags (black & red checks)	22
3'x8' Dealership Identity Flags	22
Dealer Logo & Message Bracket Flags	26
45"x66" Rotating Bracket Flag System	26
3 1/2'x7.5' Three Panel Dealership Drapery Stack	27
3 1/2'x12' Five Panel Dealership Drapery Stack	28
Race Track Flags	21
Checked Pennant Strings	21
Car Antenna Pennants	55
Car Antenna Pennants (USA & Texas)	44
Warning Flags & Number Kits	32
Adhesive Vinyl Numbers & Slogans	32
3 Stripe Dealer Logo Drapes	24

CUSTOM BANNERS

Appliqué (nylon wall banners)	03
Appliqué (nylon run-through banners)	03
Appliqué (nylon backdrop banners)	03
Printed Nylon Podium Banners	07
Indoor Banners and Stands	10
Printed Poly Banners (spot colors)	13
Digital Vinyl Banners (full colors)	12
Printed Poly Banners (spot colors)	13
Printed Vinyl, Sunbrella & Nylon Avenue Banners	16
Net Banners (over head street banners)	11
Vinyl Lettered & Digitally Printed Banners	15
Printed Vinyl Mesh Banner	11

CUSTOM FLAGS

Appliqué Flags	03
Feather & Shark Fin Flag	04-06
Printed (Full color) Nylon & Poly-Knit Flags	09

CUSTOM PENNANT STRINGS

Printed (poly & vinyl plastic-cloth)	17
--------------------------------------	----

CUSTOM MISCELLANEOUS

Printed Die-Cut Decals	20
Printed Static Cling Window Vinyl	20
Printed Magnetic Signs (autos)	19
Printed Vinyl Fleet Markings (trucks)	19
Printed Corrugated Plastic (coroplast)	18
Printed Styrene Signs	14

Table Covers

Appliqué Table Drapes	08
Printed Table Drapes	08

STOCK BANNERS - FLAGS - PENNANTS - POLES

3'x10' & 3'x20' Vinyl Message Banners	33-37
3'x5' & 3'x10' Poly Message Banners	42
Warning Pennant Strings	41
Pleated Fans & Pull Down Fans	44
U.S. & Texas Nylon & Poly-Knit Flags	43
USA Poly Pennant Strings & Patriotic Bunting	43
Steel & Aluminum In-Ground Flag Poles	45
Nylon Sail Flags	51
Attention Solid & Striped Nylon Flags	52-53
CNC Routers- Cut & Print	54
Bunting Materials (poly, vinyl, nylon)	55
Vinyl & Metallic Printed Message Pennants Strings	40
Pennant Strings (vinyl, metallic, poly)	56-66
State & International Flags	43,46-50
Bracket & Pole Mounting Hardware	67
Holiday Flags & Banners	38-39

APPLIQUE FLAGS & BANNERS

APPLIQUE FLAGS

(see complexity price guide & color options at bottom)

STYLE	SIZE	VERY SIMPLE	SIMPLE	AVERAGE	COMPLEX	VERY COMPLEX
AF23	2'x3'	\$143.15	\$186.23	\$297.80	\$390.47	\$585.04
AF35	3'x5'	\$186.23	\$248.77	\$356.05	\$455.32	\$676.37
AF46	4'x6'	\$225.14	\$290.46	\$415.61	\$512.73	\$772.98
AF58	5'x8'	\$268.22	\$394.71	\$546.65	\$676.37	\$905.34
AF610	6'x10'	\$394.71	\$498.93	\$688.27	\$917.86	\$1,150.22
AF812	8'x12'	\$542.02	\$728.24	\$1,008.58	\$1,379.20	\$1,732.52
AF1015	10'x15'	\$654.58	\$853.31	\$1,421.54	\$1,778.92	\$2,484.41
AF1218	12'x18'	\$946.85	\$1,274.44	\$2,047.61	\$2,816.63	\$3,327.53

APPLIQUE BANNERS

(see complexity price guide & color options at bottom)

STYLE	SIZE	VERY SIMPLE	SIMPLE	AVERAGE	COMPLEX	VERY COMPLEX
AB24S	2'x4'	\$191.39	\$212.65	\$256.38	\$416.93	\$478.82
AB26S	2'x6'	\$214.35	\$238.17	\$279.43	\$424.06	\$487.10
AB36S	3'x6'	\$229.38	\$255.01	\$287.53	\$427.74	\$491.88
AB38S	3'x8'	\$248.64	\$276.27	\$317.09	\$543.76	\$625.33
AB310S	3'x10'	\$309.67	\$344.07	\$396.34	\$679.70	\$781.65

APPLIQUE BACKDROPS

(see complexity price guide & color options at bottom)

STYLE	SIZE	VERY SIMPLE	SIMPLE	AVERAGE	COMPLEX	VERY COMPLEX
BD58	5'X8'	\$267.16	\$411.54	\$546.15	\$664.37	\$873.83
BD610	6X10'	\$435.82	\$530.28	\$700.35	\$913.67	\$1,121.85
BD812	8'X12'	\$615.28	\$810.93	\$1,033.19	\$1,373.71	\$1,696.27
BD1015	10'X15'	\$786.65	\$968.79	\$1,477.81	\$1,804.21	\$2,448.02
BD1218	12'X18'	\$1,137.47	\$1,437.01	\$2,129.33	\$2,830.97	\$3,297.44

APPLIQUE RUN-THROUGH'S

(see complexity price guide & color options at bottom)

STYLE	SIZE	VERY SIMPLE	SIMPLE	AVERAGE	COMPLEX	VERY COMPLEX
RT58	5'X8'	\$287.40	\$437.17	\$582.13	\$708.06	\$930.37
RT610	6'X10'	\$464.16	\$565.35	\$745.33	\$972.77	\$1,193.81
RT812	8'X12'	\$628.77	\$836.57	\$1,100.00	\$1,462.38	\$1,805.50
RT1015	10'X15'	\$837.92	\$1,030.87	\$1,572.90	\$1,919.86	\$2,604.80
RT1218	12'X18'	\$1,210.31	\$1,528.76	\$2,265.54	\$3,012.15	\$3,508.18

FLAGS	BANNERS
<ul style="list-style-type: none"> ✓ 200 Denier Nylon ✓ Reinforced Stitching ✓ Four rows of stitching ✓ Strong Canvas Heading ✓ 2 Brass Grommets ✓ Poly Bagged 	<ul style="list-style-type: none"> ✓ 200 Denier Nylon ✓ Reinforced Stitching ✓ 1" Sleeve At Top ✓ Includes: Aluminum Pole ✓ Includes: Acorn End Caps ✓ Includes: Bottom Fringe ✓ Includes: Tassel Cord

For Indoor Flag 3'x5' Add: \$47.30
 For Indoor Flag 4'x6' Add: \$63.85
 For Indoor Flag 5'x8' Add: \$90.15

Tassel Cord & Fringe Colors
Golden Yellow
White
Royal Blue

RUN-THROUGH BANNERS	BACKDROP BANNERS
<ul style="list-style-type: none"> ✓ 200 Denier Nylon ✓ Reinforced Stitching ✓ 2 Vertical Sleeves ✓ 2 D-Rings At Top Of Sleeves ✓ Center Velcro Closure ✓ A Must For Football Teams 	<ul style="list-style-type: none"> ✓ 200 Denier Nylon ✓ Reinforced Stitching ✓ 1 Horizontal Sleeve At Top ✓ Optional Grommets Instead Of Sleeves

Applique Flags are priced standard with header & grommets. Imprint on one side. (reads reverse on back). To keep your flag flying, please consider size and weight factors when ordering 2 sided flags. *Some Intricate artwork may be printed then stitched on for a sleek and sharp appearance. Sewn letters must be a minimum of 1" tall.

Indoor Flags includes Fringe on 3 sides, pole sleeve to fit up to a 1 1/4" pole inside of sleeve. (secures flag to pole). See fringe colors above.

Applique Banners are priced standard with sleeve at top and includes a sectional aluminum pole, acorn end caps, bottom fringe and a tassel cord to hang banner. *Some Intricate artwork may be printed then stitched on for a sleek and sharp appearance. Sewn letters must be a minimum of 1" tall.

Run-through and backdrop banners are priced standard with applique imprint on front only. Run-through banners are sewn with center velcro closure and two vertical sleeves with d-rings (use d-rings to secure banner in place). Backdrop banners are sewn with sleeve at top or grommets top and bottom. * Intricate artwork will be printed then stitched on for a sleek and sharp appearance. Sewn letters must be a minimum of 1" tall.

SEWING OPTIONS	
2 Sided (Flag/Banner); (RT's & AB's)	Price x 1.8
Back / Opaque Liner (Flag/Banner); (RT's, BD's & AB's)	\$1.00 Per Square Foot
D-Rings (Flag/Banner); (Across Top - (BD's)	\$4.00 Per D-Ring
Extra Grommets (Flag/Banner); (BD's & AB's)	\$0.50 Per Grommet
Wind Slits (RT's, BD's & AB's)	\$10.00 Per Slit

OPTIONAL FLAG SHAPES AVAILABLE:

PENNANT

GUIDON

BURGEE



VERY SIMPLE



SIMPLE



AVERAGE



COMPLEX



VERY COMPLEX



APPLIQUE FLAG



RUN THROUGH BANNER



BACK DROP BANNER



APPLIQUE BANNER



Submit Artwork To Confirm Price!

POLY-KNIT FEATHER & SHARK FIN FLAGS

STOCK DESIGN PRICING

STOCK SHARKFIN & FEATHER FLAG- FLAG ONLY A

PRODUCT CODE: FFPK	QTY:	1	3	6	11
8' STOCK SHARKFIN & FEATHER FLAG		\$68.86	\$64.57	\$62.68	\$61.26
12' STOCK SHARKFIN & FEATHER FLAG		\$77.36	\$72.56	\$70.42	\$68.83

STOCK SHARKFIN & FEATHER FLAG-POLE KIT INCLUDED

PRODUCT CODE: FFPK	QTY:	1	3	6	11
8' STOCK SHARKFIN & FEATHER FLAG		\$145.81	\$141.52	\$139.62	\$138.20
12' STOCK SHARKFIN & FEATHER FLAG		\$154.31	\$149.50	\$147.37	\$145.77

STOCK NYLON SOLID COLOR FEATHER FLAGS

STYLE	SIZE	1	3	6	11
FF308C	30"x 8'	\$45.32	\$42.37	\$40.61	\$37.96
FF312C	30"x12'	\$65.33	\$62.67	\$60.73	\$57.09

* Select Style & Color Numbers When Ordering.

AVAILABLE IN ALL COLORS



POLE KITS ON PG. 6

CUSTOM DESIGN PRICING

CUSTOM SHARKFIN & FEATHER FLAG- FLAG ONLY A

PRODUCT CODE: FFPK	QTY:	1	3	6	11
8' CUSTOM SHARKFIN & FEATHER FLAG		\$146.72	\$110.44	\$95.50	\$89.10
12' CUSTOM SHARKFIN & FEATHER FLAG		\$157.92	\$132.31	\$107.23	\$99.23

CUSTOM SHARKFIN & FEATHER FLAGS - POLE KIT INCLUDED A

PRODUCT CODE: FFPK	QTY:	1	3	6	11
8' CUSTOM SHARKFIN & FEATHER FLAG		\$223.66	\$187.39	\$172.48	\$166.05
12' CUSTOM SHARKFIN & FEATHER FLAG		\$234.86	\$209.25	\$184.17	\$176.18

No Setup Charge!

Available in Nylon!

Call for pricing



STOCK DESIGNS AVAILABLE IN SHARKFIN & FEATHER FLAGS



POLY-KNIT FEATHER & SHARK FIN FLAGS



PIZZ1



VAPE1

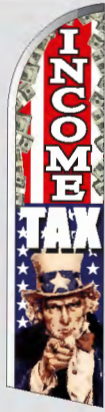

TAX2

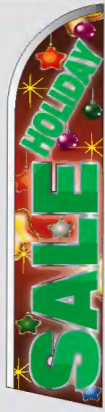

HOLI1



TIRE1



4TH1



BURG1



SODA1



TACO1



TACO2



USA2

C



CARW1



FURN1



CERT1



HAIR1



ICEC1



DAYC1



OIL1



TAX3

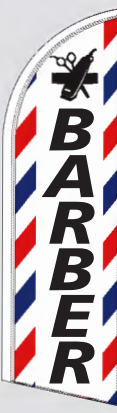

BARB1



USED1



TEX1



SALE1



SALE2



SALE3



SALE4



SALE5



SALE6



SALE7



CARW2



LOOK1



LOOK2



PAWN1



GRAN1



GRAN2



NOWO1



OPEN2



OPEN3



OPEN4



CARS1



CARS2



CARS3



CARS4



CERT1

C

HEAVY DUTY STRAIGHT ALUMINUM POLES WITH GROUND SOCKET

STYLE	SIZE	1-5	6-10	11-15	16-24	25-40	41-100
SAP310	10'	\$35.00	\$34.00	\$32.00	\$31.00	\$30.50	\$30.00
SAP314	14'	\$45.00	\$44.00	\$43.50	\$43.00	\$42.50	\$42.00

FIBERGLASS POLES

STYLE	SIZE	1-250
FP10	10'	\$44.99
FP313	13'	\$54.99

CARRYING CASE POLE / DISPLAY

STYLE	1-250
CCP	\$6.50

GROUND SOCKET

STYLE	1-250
GSA9	\$8.00

ROTATING GROUND SPIKE

STYLE	1-250
GSR20	\$24.99

GROUND SPIKE STATIONARY

STYLE	1-250
GSS30	\$20.99

FEATHER / SHARKFIN FLAG BASE

STYLE	1-250
FF-SF	\$35.85

Rotating Ground Spike

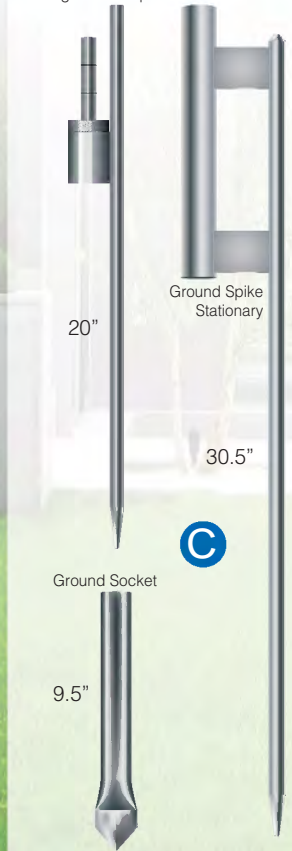

15ft. ADVERTISING POLE KIT

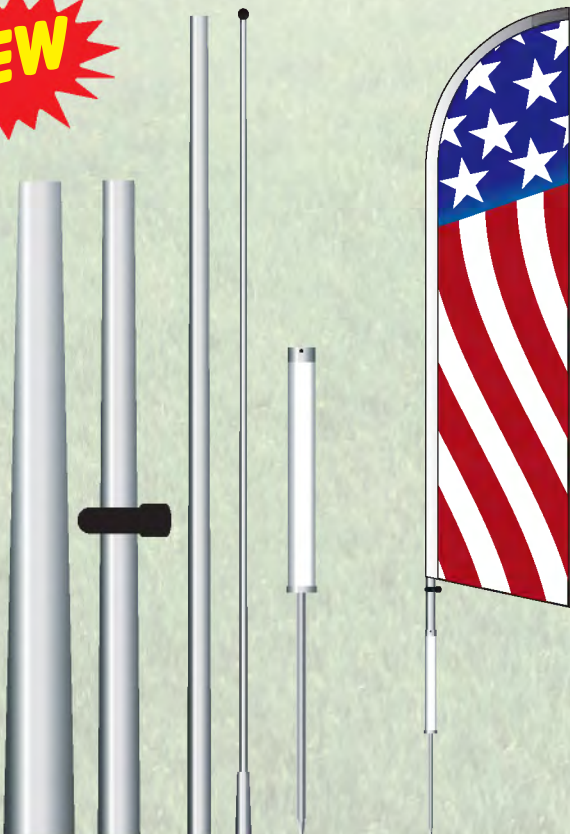

POLE TOPPER

STYLE	1-250
FT01	\$9.50



15ft. ADVERTISING POLE KIT

- 1 x 4pc Pole (2 Fiberglass/2 Aluminum)
- 1 x Adjustable Hook
- 1 x Small Clip to clip at the top of the flag
- 1 x Ground Spike

15ft Advertising Pole Kit

STYLE	SIZE	1-100
FIB310	15'	\$69.99

DISCLAIMER:

Do not display Feather flags/Sharkfin flags outdoors during extreme wind conditions. (Maximum Wind Tolerance is Approximately 15-20 m.p.h)

PRINTED POLYESTER BANNERS

FULL COLOR POLYESTER BANNERS/PARADE BANNERS

STYLE	SIZE	1-5	6-10	11-24	25-50	51-100
FCB23	2'x3'	\$83.76	\$73.28	\$62.80	\$31.40	\$26.18
FCB25	2'x5'	\$139.57	\$122.14	\$104.70	\$52.33	\$43.62
FCB26	2'x6'	\$167.50	\$146.56	\$125.62	\$62.80	\$52.33
FCB28	2'x8'	\$223.32	\$195.41	\$167.50	\$83.76	\$69.79
FCB36	3'x6'	\$251.25	\$219.84	\$188.42	\$94.22	\$78.52
FCB38	3'x8'	\$335.00	\$293.12	\$251.25	\$125.62	\$104.70
FCB310	3'x10'	\$418.74	\$366.40	\$314.06	\$157.02	\$130.86

CUSTOM PRINTED POLYESTER PODIUM BANNERS

STYLE	SIZE	1-2	3-5	6-11	12-25	26-50
PNB1824	18"x24"	\$106.03	\$74.66	\$50.77	\$34.36	\$25.39
PNB2024	20"x24"	\$149.34	\$137.39	\$120.96	\$95.57	\$73.17
PNB2226	22"x26"	\$180.70	\$150.83	\$125.44	\$100.05	\$74.66

BANNER ADD-ONS & HARDWARE

NAME	PRICE
GOLD FRINGE	\$1.29 / ft
POLE HEM	\$4.20 / ft
NYLON COVERED HEADER	\$5.99 / ft
BACK NYLON LINER	\$0.80 / sq.ft.
EXTRA GROMMETS	\$0.80 each
POLE 1" ALUMINUM	\$2.50 / ft
3/8 WOODEN DOWELS	\$0.24 / ft
ACORN	\$2.80 each
WOOD SPEAR	\$0.53 each
TASSLE 24", 36", 48"	\$8.80, \$10.00, \$11.50
HOOK & LOOP	\$2.80 / ft
SCALLOP BOTTOM	\$4.00 / ft

NO MINIMUMS!

SEWING EXTRAS		
HOOK & LOOP TOP OR BOTTOM	\$4.50	(sleeve is removed)
WEIGHTED BOTTOM	\$4.50	(works with sleeve only)

* 2 Styles to choose From (Style "A" & Style "B")

STYLE "A"



Tassel Cord & Fringe Colors
Golden Yellow
White
Royal Blue

STYLE "B"



NYLON and SATIN AVAILABLE
CALL FOR PRICING...

WE ALSO MAKE
CUSTOM SIZES!



PHOTO COURTESY OF LEON VALLEY FIRE DEPT.

C

POLYESTER & APPLIQUE TABLE DRAPES

Artwork Requirements on page 3

POLYESTER SADDLE TABLE DRAPE C

TABLE SIZE	1-2	3-5	6-10	11+
30"x30"x72"	\$293.00	\$222.00	\$184.00	\$172.00
30"x30"x96"	\$313.00	\$249.00	\$207.00	\$193.00

- ✓ Polyester
- ✓ Most PMS Color Matches
- ✓ Covers Front, Top, and Back
- ✓ Full 4CP Print

POLYESTER FITTED TABLE DRAPE C

TABLE SIZE	1-2	3-5	6-10	11+
30"x30"x72"	\$308.00	\$236.00	\$198.00	\$186.00
30"x30"x96"	\$328.00	\$263.00	\$221.00	\$207.00

- ✓ Polyester
- ✓ Most PMS Color Matches
- ✓ Covers Front, Top, and Sides
- ✓ Full 4CP Print
- ✓ Back Left Open

POLYESTER FULL-COVER TABLE DRAPE C

TABLE SIZE	1-2	3-5	6-10	11+
30"x30"x72"	\$345.00	\$251.00	\$213.00	\$201.00
30"x30"x96"	\$373.00	\$278.00	\$236.00	\$222.00

- ✓ Polyester
- ✓ Most PMS Color Matches
- ✓ Covers Four Sides, and Top
- ✓ Full 4CP Print

APPLIQUE FITTED TABLE DRAPE

SIZE	VERY SIMPLE	SIMPLE	AVERAGE	COMPLEX	VERY COMPLEX
30"x30"x48"	\$217.67	\$272.15	\$340.19	\$425.24	\$531.54
30"x30"x72"	\$326.50	\$391.80	\$470.16	\$564.20	\$677.04
30"x30"x96"	\$435.33	\$500.63	\$575.72	\$662.08	\$761.39

* No setup charges on exact repeat orders. (must order at least once every 12 months) C

- ✓ 200 Denier Nylon
- ✓ Appliqued
- ✓ Up To Four Nylon Colors
- ✓ Front Panel Appliqued
- ✓ Covers Four Sides
- ✓ Back Left Open



FITS STANDARD FOLDING TABLES

No Setup Charge!

Available in Nylon!
Call for pricing



SADDLE TABLE DRAPE

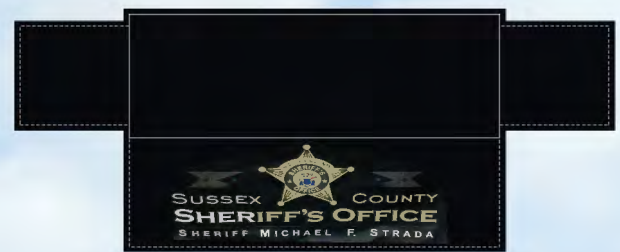
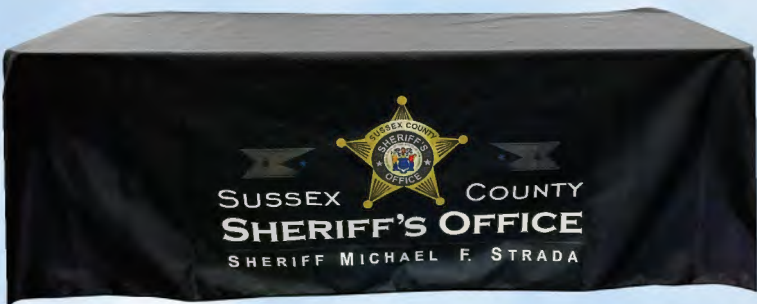

FITTED TABLE DRAPE



FULL-COVER TABLE DRAPE

PRINTED NYLON & POLY-KNIT FLAGS

CUSTOM FULL COLOR NYLON FLAGS A

STYLE	SIZE	1-2	3-5	6-10	11-15	16-24	25-40	41-100	101+
SNF23	2'x3'	\$86.99	\$73.99	\$63.99	\$49.99	\$39.00	\$35.49	\$31.50	\$29.49
SNF35	3'x5'	\$119.33	\$99.99	\$79.99	\$69.99	\$53.99	\$48.49	\$46.49	\$44.49
SNF46	4'x6'	\$159.99	\$139.00	\$113.99	\$99.99	\$73.66	\$65.49	\$60.49	\$57.49
SNF58	5'x8'	\$239.99	\$203.99	\$179.99	\$143.39	\$109.99	\$92.49	\$84.49	\$80.49
SNF610	6'x10'	\$366.99	\$309.99	\$269.99	\$219.99	\$169.99	\$138.49	\$122.49	\$116.49
SNF812	8'x12'	\$586.56	\$496.32						
SNF1015	10'x15'	\$916.50	\$775.50						
SNF1218	12'x18'	\$1319.76	\$1116.72						
SNF1525	15'x25'	\$2291.25	\$1938.75						

CUSTOM FULL COLOR NYLON FLAGS (SMALL SIZES) A

STYLE	SIZE	1-2	3-5	6-11	12-25	26-50	51-100	100-250	251-500
SNFS1218	12"x18"	\$33.99	\$23.99	\$16.99	\$14.99	\$12.99	\$10.99	\$9.99	\$8.99
SNFS1624	16"x24"	\$43.99	\$29.99	\$19.99	\$17.99	\$16.99	\$14.99	\$13.99	\$11.99
SNFS1420	14"x20"	\$59.99	\$49.99	\$39.99	\$17.99	\$16.66	\$14.66	\$13.66	\$11.66

* No setup charges on exact repeat orders. (must order at least once every 12 months)

Digitally printed Nylon flags are priced printed on one side sewn with header and brass grommets. Four-Color Process Images with up to 60% ink coverage. Horizontal design with single panel construction. Digitally printed for superior results using proven UV resistant ink systems. Flag reads reverse on backside. For full bleeds please add a 25% sur-charge. For special sewing configurations, large quantities or special requirements please contact the factory for a written quote. Listed sizes are before sewing.

CUSTOM PRINTED POLY-KNIT FLAGS A

STYLE	SIZE	1-2	3-5	6-10	11-15	16-24	25-40	41-100	101+
SNP23	2'x3'	\$73.99	\$62.99	\$54.49	\$42.49	\$33.29	\$27.49	\$24.29	\$22.39
SNP35	3'x5'	\$101.49	\$84.99	\$67.99	\$59.49	\$45.99	\$35.99	\$33.49	\$30.89
SNP46	4'x6'	\$135.99	\$118.29	\$96.99	\$84.99	\$62.69	\$50.49	\$44.49	\$41.99
SNP58	5'x8'	\$203.99	\$173.39	\$152.99	\$121.99	\$93.49	\$73.39	\$64.89	\$61.49
SNP610	6'x10'	\$311.99	\$263.49	\$229.49	\$186.99	\$144.49	\$112.49	\$95.49	\$90.99

OPTIONAL
FLAG SHAPES
AVAILABLE:



Artwork Requirements on page 2

A

OPTIONS	
Polyester Backgrounds	Add 35%
2 Sided Flag (seal only)	Price x 1.5
2 Sided Seal Flag With Liner	Price x 1.7
2 Sided Flag With Liner	Price x 2
Shadow Liner (for 2 sided)	\$1.00 Sq Ft
Pole Sleeve (fits 1/2 pole)	\$4.20 / Ft
Pole Sleeve (Fits 3/4" Pole)	\$6.90 / Ft
2 Sided Seals (1 ply)	Price x 1.5
2 Sided Flag Without Liner (2 ply)	Price x 1.8
2 Sided Flag With Liner (3 ply)	Price x 2
Pennant Shape Design	\$2.75
Burgee or Guideon Design	\$4.50
Steel D-Rings (instead of grommets)	\$4.00 Each
Mounted To Dowel	\$1.85
Grommets	\$ 0.80 Each

- ✓ 200 Denier Nylon Material
- ✓ Reinforced Fly End
- ✓ 200 Denier Nylon Material
- ✓ Durable Canvas Heading
- ✓ Most PMS Color Matches
- ✓ 4 Rows Of Stitching
- ✓ 2 Sturdy Brass Grommets
- ✓ Reads Reverse On Back
- ✓ Digitally Printed
- ✓ Poly Bagged

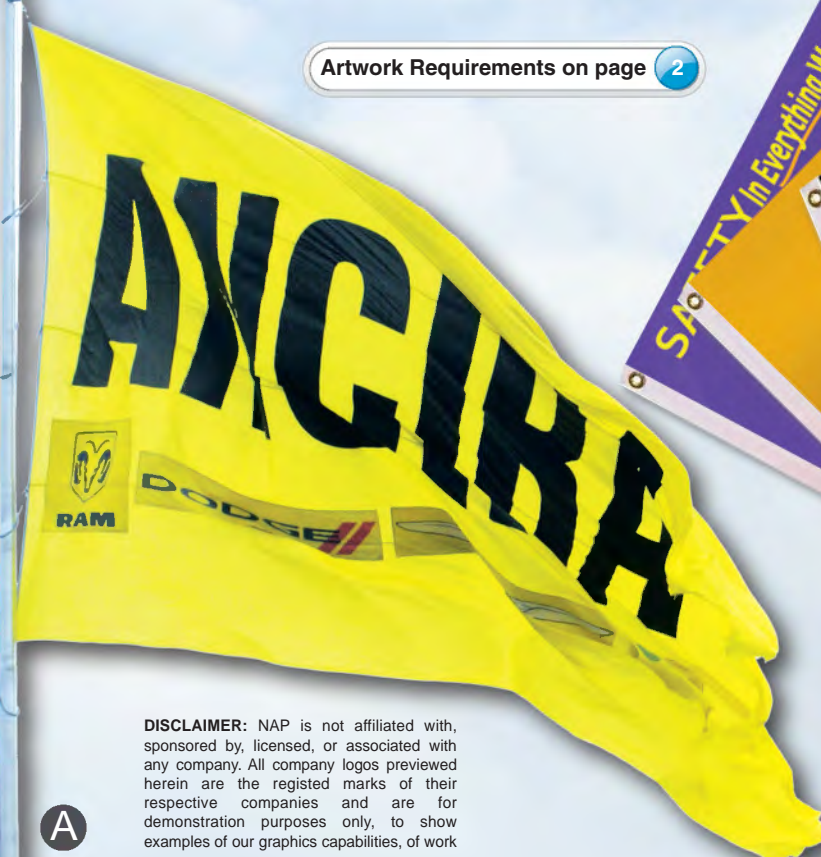

DISCLAIMER: NAP is not affiliated with, sponsored by, licensed, or associated with any company. All company logos previewed herein are the registered marks of their respective companies and are for demonstration purposes only, to show examples of our graphics capabilities, of work

INDOOR DISPLAY BANNERS & STANDS

FULL COLOR NYLON DISPLAY BANNERS C

STYLE	SIZE	STAND	1	3	6	12	24	48	NET SETUP
NBN1824	18"X24"	BN1	\$24.08	\$22.47	\$20.87	\$19.23	\$15.73	\$12.20	\$65.00
NBN1836	18"X36"	BN1	\$36.11	\$33.71	\$31.30	\$28.84	\$23.59	\$18.30	\$65.00
NBN1842	18"X42"	BN1	\$42.13	\$39.32	\$36.51	\$33.64	\$27.52	\$21.35	\$65.00
NBN2436	24"X36"	BN2	\$48.15	\$44.94	\$41.73	\$38.46	\$31.46	\$24.40	\$65.00
NBN2448	24"X48"	BN2	\$69.55	\$59.92	\$55.64	\$51.27	\$41.94	\$32.53	\$65.00
NBN2460	24"X60"	BN2	\$80.25	\$74.90	\$69.55	\$64.09	\$52.43	\$40.66	\$65.00
NBN2472	24"X72"	BN2	\$96.30	\$89.88	\$83.46	\$76.91	\$62.92	\$48.79	\$65.00
NBN2484	24"X84"	BN2	\$112.35	\$104.86	\$97.37	\$89.73	\$73.40	\$56.92	\$65.00
NBN2496	24"X96"	BN2	\$128.40	\$119.84	\$111.28	\$102.55	\$83.89	\$65.06	\$65.00
NBN3648	36"X48"	BN3	\$96.30	\$89.88	\$83.46	\$76.91	\$62.92	\$48.79	\$65.00
NBN3660	36"X60"	BN3	\$120.38	\$112.35	\$104.33	\$96.14	\$78.65	\$60.99	\$65.00
NBN3672	36"X72"	BN3	\$144.45	\$134.82	\$125.19	\$115.37	\$94.37	\$73.19	\$65.00
NBN3684	36"X84"	BN3	\$167.99	\$157.29	\$146.06	\$134.60	\$110.10	\$85.39	\$65.00
NBN3696	36"X96"	BN3	\$192.60	\$179.76	\$166.92	\$153.82	\$125.83	\$97.58	\$65.00
NBN36108	36"X108"	BN3	\$216.68	\$202.23	\$187.79	\$173.05	\$141.56	\$109.78	\$65.00

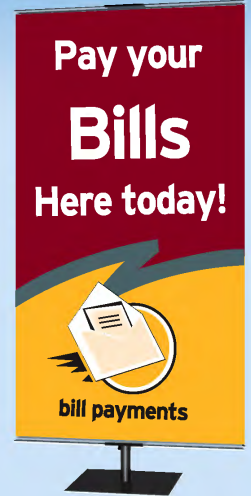
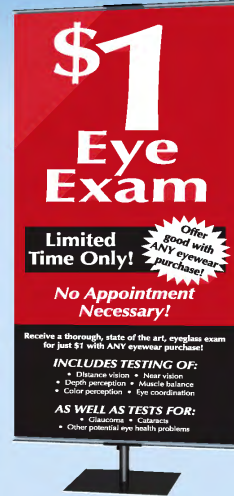

FULL COLOR VINYL DISPLAY BANNERS C

STYLE	SIZE	STAND	1	3	6	12	24	48	NET SETUP
VBN1824	18"X24"	BN1	\$20.87	\$19.40	\$17.12	\$13.70	\$10.51	\$9.07	\$65.00
VBN1836	18"X36"	BN1	\$31.30	\$29.08	\$25.66	\$20.46	\$15.74	\$13.58	\$65.00
VBN1842	18"X42"	BN1	\$36.51	\$33.93	\$29.94	\$23.93	\$18.36	\$15.94	\$65.00
VBN2436	24"X36"	BN2	\$41.73	\$38.78	\$34.22	\$27.35	\$20.99	\$18.10	\$65.00
VBN2448	24"X48"	BN2	\$55.64	\$51.70	\$45.62	\$36.47	\$27.99	\$24.14	\$65.00
VBN2460	24"X60"	BN2	\$69.55	\$64.63	\$57.03	\$45.58	\$34.99	\$30.17	\$65.00
VBN2472	24"X72"	BN2	\$83.46	\$77.55	\$68.44	\$54.70	\$41.99	\$36.21	\$65.00
VBN2484	24"X84"	BN2	\$97.37	\$90.48	\$79.84	\$63.81	\$48.98	\$42.24	\$65.00
VBN2496	24"X96"	BN2	\$111.28	\$103.40	\$91.25	\$72.93	\$55.98	\$48.28	\$65.00
VBN3648	36"X48"	BN3	\$83.46	\$77.55	\$68.44	\$54.70	\$41.99	\$36.21	\$65.00
VBN3660	36"X60"	BN3	\$104.33	\$96.94	\$85.55	\$68.37	\$52.48	\$45.26	\$65.00
VBN3672	36"X72"	BN3	\$125.19	\$116.33	\$102.66	\$82.05	\$62.98	\$54.31	\$65.00
VBN3684	36"X84"	BN3	\$146.06	\$135.72	\$119.77	\$95.72	\$73.48	\$63.37	\$65.00
VBN3696	36"X96"	BN3	\$166.92	\$155.11	\$136.87	\$109.40	\$83.97	\$72.42	\$65.00
VBN36108	36"X108"	BN3	\$187.79	\$174.50	\$153.98	\$123.07	\$94.47	\$81.47	\$65.00

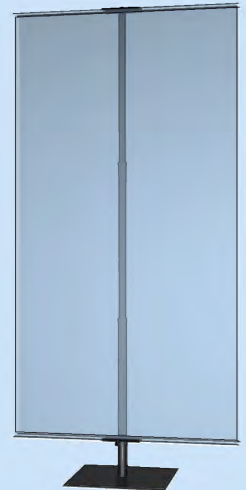

BANNER STANDS: C

STYLE	SIZE	1-3	6-12	24-48
BN1	18"	\$125.83	\$124.37	\$123.74
BN2	24"	\$170.49	\$167.19	\$153.99
BN3	36"	\$267.44	\$265.10	\$258.49

BANNERS:

Nylon or Vinyl Material
Sleeves Top Bottom
Digitally Printed
Printed 1 Sided
Most PMS Matches

BN1 STAND

Height Adjusts from 24" - 42"
Accepts Banners 18" Wide
1/2" Dowels Included
8" Square Base
Display 1 or 2 Banners

BN2 STAND

Height Adjusts from 36" - 96"
Accepts Banners 24" Wide
1/2" Dowels Included
12" Square Base
Display 1 or 2 banners

BN3 STAND

Height Adjusts From 42" - 118"
Accepts Banners 36" Wide
1/2" Dowels Included
16" Square Base
Display 1 or 2 Banners



APPLIQUE & DIGITALLY PRINTED NET BANNERS

APPLIQUE NET BANNERS ARE CONSTRUCTED FROM DURABLE NET MATERIAL WITH 200 DENIER NYLON LETTERING WHICH IS STITCHED DIRECTLY ON TO THE MESH. BANNERS ARE FINISHED WITH HEMP CORNER ROPE AND CABLE SNAPS ALONG THE TOP PERIMETER.

STYLE	SIZE	NETTING	LETTERING
NET415	4'x15'	\$157.50	\$7.50 Per Character *
NET420	4'x20'	\$210.00	\$7.50 Per Character *
NET425	4'x25'	\$262.50	\$7.50 Per Character *
NET430	4'x30'	\$300.00	\$7.50 Per Character *
NET435	4'x35'	\$367.50	\$7.50 Per Character *
NET440	4'x40'	\$420.00	\$7.50 Per Character *
NET445	4'x45'	\$472.50	\$7.50 Per Character *
NET450	4'x50'	\$525.00	\$7.50 Per Character *
NET455	4'x55'	\$577.50	\$7.50 Per Character *

STYLE	SIZE	VINYL MESH	NET SETUP
MSH415	4'x15'	\$420.00	\$75.00
MSH420	4'x20'	\$560.00	\$75.00
MSG425	4'x25'	\$700.00	\$75.00
MSH430	4'x30'	\$840.00	\$75.00
MSH435	4'x35'	\$980.00	\$75.00
MSH440	4'x40'	\$1120.00	\$75.00
MSH445	4'x45'	\$1260.00	\$75.00
MSH450	4'x50'	\$1400.00	\$75.00
MSH455	4'x55'	\$1540.00	\$75.00

LETTERING & BORDER COLORS FOR APPLIQUE

White	
Black	Orange
OG Red	Spice Brown
OG Blue	Royal Blue
Emerald Green	Spanish Yellow

APPLIQUE NET BANNER

* Characters are any standard symbol found on your pc keyboard. Double the letter count for outlined lettering.



CUSTOM LENGTH PRICES
NETCS \$10.50 Per Linear Foot

REMOVABLE HOOK & LOOP DATE & LOGO PATCHES
DATEP \$95.00 Permanent Patch
LOGOP \$108.00 Hook & Loop Logo or Custom Date Patch

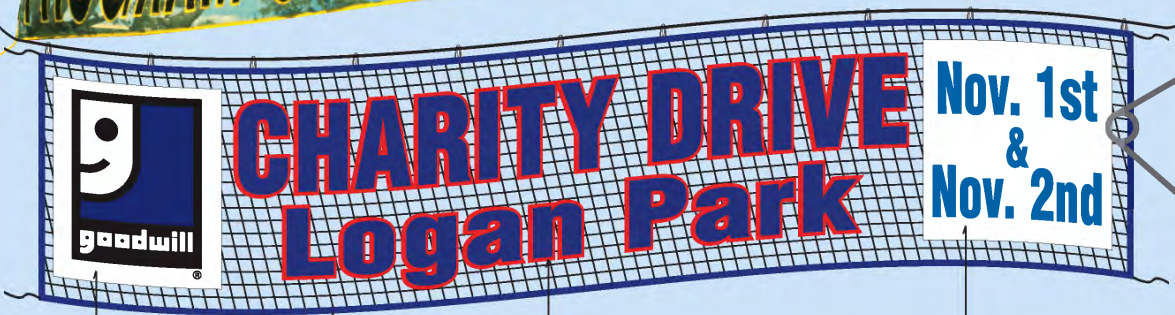

Logo Patch

Border Color

Blue Text with Red Outlined

Date Patch

DIGITAL MESH BANNER



DIGITALLY PRINTED VINYL MESH BANNERS ARE PRINTED ON DURABLE VINYL MESH MATERIAL AND SEWN WITH WEBBING CORNER D-RINGS AND CABLE SNAPS ALONG TOP PERIMETER. BANNER CAN ALSO BE SEWN WITH GROMMETS IF NOT BEING PRODUCED FOR OVERHEAD USE.

DIGITALLY PRINTED BANNERS



13OZ FULL COLOR VINYL BANNERS

STYLE	SIZE	1-2	3-5	6-10	11-25	26-50	51-100	101-200	201-300	301-400	401-500
24	2'x4'	\$40.00	\$29.20	\$18.20	\$16.99	\$16.00	\$15.33	\$14.33	\$12.69	\$11.99	\$11.03
26	2'x6'	\$60.00	\$38.80	\$27.30	\$25.47	\$24.00	\$22.99	\$21.49	\$19.03	\$17.97	\$16.53
36	3'x6'	\$90.00	\$53.20	\$40.95	\$38.21	\$36.00	\$34.48	\$32.23	\$28.54	\$26.96	\$24.80
38	3'x8'	\$120.00	\$67.60	\$54.60	\$50.92	\$48.00	\$45.96	\$42.96	\$38.04	\$35.93	\$33.03
310	3'x10'	\$150.00	\$84.48	\$68.25	\$63.63	\$60.00	\$57.45	\$53.70	\$47.55	\$44.91	\$41.28

ADDITIONAL OPTIONS

Double Sided Banner	Price x 1.8
Re-Shipper Container (Box)	\$2.25
Wind Reduction Slit	\$2.00 Per Slit
Extra Grommets	\$0.50 Per Grommets
Extra Nylon Cord	\$0.40 Per Linear Foot
Rope & Grommets	\$0.20 Per Foot
Pole Sleeve's	\$0.60 Per Foot
Wind Slit's	\$0.60 Per Foot

DIGITAL 70/30 VINYL MESH BANNER (2'x3' OR BIGGER SEW WITH HEM AND GROMMETS)

QUANTITY	1-6	6-9	10-24	25-29	50-99	100-199	200-299	300-500
Price per sq.ft	\$5.70	\$4.30	\$3.80	\$3.30	\$3.05	\$2.80	\$2.20	\$1.90

- ✓ 13oz Reinforced Vinyl
- ✓ Perimeter Hem
- ✓ Double Stitched
- ✓ Sturdy Brass Grommets
- ✓ Digitally Printed
- ✓ Larger Sizes Available
- ✓ See Artwork requirements on page 2

**UP TO 192"
WIDE BY MOST
ANY LENGTH**

Go for it!



Most orders shipped in 5-6 working days after artwork or disk is received and credit approval quotation. Consult factory for how to prepare your computer file.



Go for it!

**AS LOW AS
\$1.60/SQ.FT.
NET SETUP: \$75.00**



Year: 2021

CUSTOM PRINTED POLY & VINYL BANNERS

OUR CUSTOM POLY BANNERS ARE THE PERFECT FRANCHISE MARKETING TOOL WHERE COST PLAYS A KEY ROLE. OUR SMALL MINIMUM ORDER REQUIREMENTS MAKE IT EASY TO LAUNCH THESE BANNERS IN A VARIETY OF APPLICATIONS. THESE LOW COST BANNERS ARE AN EXCELLENT VALUE, AND WILL INTEGRATE SEAMLESSLY WITH OTHER MARKETING PROGRAMS. WE OFFER MANY FINISHING OPTIONS TO ENSURE EASE OF USE AND INSTALLATION FOR YOUR PARTICULAR REQUIREMENTS. FOR LARGE QUANTITIES PLEASE CALL FACTORY.

8 MIL POLYETHYLENE BANNERS

STYLE	SIZE	25-50	51-100	101-200	NET SETUP
PO15	1'x5'	\$8.11	\$6.84	\$5.61	\$45.00
2 nd color		\$3.74	\$2.50	\$1.24	\$20.00
PO25	2'x5'	\$16.60	\$15.35	\$14.70	\$65.00
2 nd color		\$6.24	\$3.74	\$3.74	\$30.00
PO35	3'x5'	\$24.95	\$22.46	\$21.21	\$65.00
2 nd color		\$6.24	\$4.99	\$3.74	\$30.00
PO38	3'x8'	\$29.94	\$27.45	\$24.95	\$75.00
2 nd color		\$6.24	\$4.99	\$3.74	\$30.00
PO310	3'x10'	\$38.68	\$34.94	\$32.44	\$110.00
2 nd color		\$7.49	\$6.24	\$4.99	\$35.00
PO315	3'x15'	\$57.39	\$54.89	\$52.40	\$150.00
2 nd color		\$9.33	\$8.16	\$7.00	\$35.00

- ✓ 8 Mil Polyethylene Back
- ✓ Sewn With Grommets or Nylon Cord
- ✓ White or Yellow Backgrounds
- ✓ Screen Printed & Digital
- ✓ Maximum Height Is 48 Inches
- ✓ Rolled & Bulk Packed

Poly banners are sewn with double perimeter hem. May be finished with nylon cord or grommets. If no sewing specified banners will be finished with heavy duty nylon rope cord. For grommets and nylon rope cord add \$2.00 (A) For custom sizes please call for quote.



ADDITIONAL OPTIONS	
Double Sided Banner	Price x 1.8
Re-Shipper Container (Box)	\$2.25
Wind Reduction Slit	\$1.00 Per Slit
Extra Grommets	\$0.50 Per Grommets
Extra Nylon Cord	\$0.40 Per Linear Foot
Rope & Grommets	\$0.20 Per Foot
Pole Sleeve's	\$0.60 Per Foot

- ✓ Several Background Color Choices
- ✓ Many Standard Sizes To Choose From
- ✓ Rolled & Bulk Packed



WE ALSO MAKE CUSTOM SIZES!



SIZES UP TO 16FT WIDE.

NO SETUP CHARGES ON EXACT REPEAT ORDERS. (MUST ORDER AT LEAST ONCE EVERY 12 MONTHS TO AVOID SETUP CHARGES). SIZE IS BEFORE SEWING. PRICES ABOVE ARE FOR UP TO 60% INK COVERAGE. FOR BLEEDS ADD 25% SURCHARGE.



CUSTOM PRINTED STYRENE SIGNS

STYRENE SIGNAGE CAN BE USED FOR A VARIETY OF APPLICATIONS INCLUDING GAS STATION PUMP TOPPERS, MENU BOARDS, POLITICAL SIGNS AND JUST ABOUT ANY TYPE OF SIGN THAT SLIDES INTO A PRE-EXISTING FRAME. YOU MAY ORDER AS FEW AS ONE. THIS MATERIAL IS AVAILABLE IN FOUR GRADES OF THICKNESS.

PRINTED STYRENE

STYLE	SIZE	25-50	51-100	101-250	250-500	NET SETUP
SPS1422	14"x22"	\$5.63	\$5.26	\$4.92	\$4.60	\$50.00
<i>Each Additional Color</i>		\$0.54	\$0.54	\$0.54	\$0.54	\$25.00
SPS1218	12"x18"	\$3.94	\$3.68	\$3.45	\$3.23	\$50.00
<i>Each Additional Color</i>		\$0.54	\$0.54	\$0.54	\$0.54	\$25.00
SPS2228	22"x28"	\$10.59	\$9.89	\$9.24	\$8.62	\$50.00
<i>Each Additional Color</i>		\$0.80	\$0.80	\$0.80	\$0.80	\$25.00
SPS2424	24"x24"	\$12.88	\$12.05	\$11.26	\$10.53	\$65.00
<i>Each Additional Color</i>		\$1.61	\$1.61	\$1.61	\$1.61	\$30.00
SPS2436	24"x36"	\$15.84	\$14.81	\$13.82	\$12.93	\$65.00
<i>Each Additional Color</i>		\$2.68	\$2.68	\$2.68	\$2.68	\$30.00
SPS2844	28"x44"	\$22.59	\$21.10	\$19.73	\$18.45	\$75.00
<i>Each Additional Color</i>		\$3.75	\$3.75	\$3.75	\$3.75	\$35.00
SPS4848	48"x48"	\$42.27	\$39.48	\$36.92	\$34.67	\$75.00
<i>Each Additional Color</i>		\$4.82	\$4.82	\$4.82	\$4.82	\$35.00
SPS4896	48"x96"	\$84.53	\$79.01	\$73.83	\$69.02	\$75.00
<i>Each Additional Color</i>		\$5.89	\$5.89	\$5.89	\$5.89	\$35.00

STYLE	SIZE	NEED JUST ONE!			
SPS100	Maximum Size is: 48"x96"	Up to 4 Colors	\$9.00 SqFt	Net Setup	\$75.00

- ✓ High Impact Styrene
- ✓ .020 Thickness
- ✓ Available In White
- ✓ Custom Sizes Available
- ✓ Order As Few As One



CALL FOR QUOTE

GENERAL USES:

- Menu Boards
- Pump Toppers
- P.O.P. Displays
- Framed Signage
- Permanent Signage

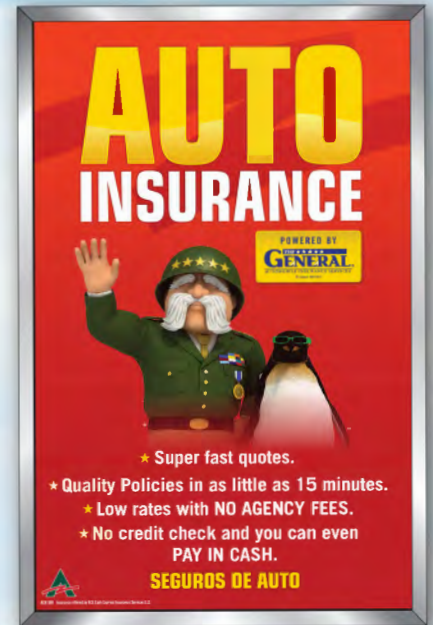

Priced as printing up to 65% ink coverage on single side of 0.020 thick white styrene material.

PLEASE CALL FACTORY FOR PRICING ON 4 COLOR PROCESS IMPRINTS OR OTHER THICKNESS GRADES.



VINYL LETTERED & DIGITALLY PRINTED BANNERS

FONT CHOICES FOR TEXT BANNER

- | | | |
|---------------------------------|---------------------------------------|-------------------------------|
| F 01 Anchen | F 10 Eurostile Black | F 18 Helvetica Rounded |
| F 02 American Typewriter | F 11 Eurostile Black Condensed | F 19 Marking Pen Heavy |
| F 03 Bookman Bold | F 12 Franklin Gothic Heavy | F 20 Optima Ultra |
| F 04 <i>Brody</i> | F 13 Friz Quadrata Bold | F 21 Rockwell Bold |
| F 05 <i>Brush Script</i> | F 14 Futura Extra Bold | F 22 Souvenir Medium |
| F 06 <i>Brushwood Italic</i> | F 15 Futura Condensed | F 23 Souvenir Bold |
| F 07 Comic Sans Bold | F 16 Helvetica Bold | F 24 STENCIL |
| F 08 Dom Casual | F 17 Helvetica Black | F 25 Stymie Black |
| F 09 Dom Casual Bold | | |



BACKGROUND COLORS



LETTERING COLORS



VINYL LETTERED BANNERS

are priced standard on reinforced vinyl with up to 4 lines of copy. Each line of text copy must be same color. You may select your font(s) from the font choices. For quantities over 5 please see printed banner pricing below.

Larger sizes available please call for quote.

TEXT ONLY BANNER

STYLE	SIZE	1-5
VLB35	3' x 5'	\$95.40
VLB36	3' x 6'	\$114.46
VLB38	3' x 8'	\$152.64
VLB30	3' x 10'	\$190.80

DIGITALLY PRINTED BANNERS

are priced standard on reinforced vinyl with no limit on text color, amount of copy lines, or quantities. You may select your font(s) from the font choices or submit your own typed document in PDF format with saved font.

Larger sizes and quantities available please call for quote.

TEXT ONLY BANNER

STYLE	SIZE	1-5	6-10	11-15	16-24
DPTB35	3'X5'	\$60.18	\$46.31	\$43.08	\$40.25
DPTB36	3'X6'	\$72.18	\$55.44	\$51.66	\$48.24
DPTB38	3'X8'	\$96.24	\$73.92	\$68.88	\$64.32
DPTB30	3'X10'	\$120.30	\$92.40	\$86.10	\$84.40

Banners on this page are sewn with grommets or rope ties. Listed prices are for grommets.



USED CARS & TRUCKS

AVENUE & POLE BANNERS

12 OZ. REINFORCED VERTICAL VINYL BANNERS (2 SIDED IMPRINT)

STYLE	SIZE	6-10	11-24	25-50	NET SETUP
VUB3060-12	30"x60"	\$81.26	\$53.75	\$51.25	\$65.00
2 nd color		\$21.03	\$19.86	\$18.69	\$25.50
VUB3072-12	30"x72"	\$90.00	\$79.99	\$62.51	\$65.00
2 nd color		\$21.03	\$19.86	\$18.69	\$25.50
VUB3096-12	30"x96"	\$111.26	\$101.49	\$83.75	\$65.00
2 nd color		\$21.03	\$19.86	\$18.69	\$25.50
VUB3672-12	36"x72"	\$96.29	\$85.57	\$66.88	\$65.00
2 nd color		\$21.03	\$19.86	\$18.69	\$25.50
VUB3696-12	36"x96"	\$115.37	\$108.33	\$89.60	\$65.00
2 nd color		\$21.03	\$21.03	\$18.69	\$25.50

- ✓ 12 oz.. Reinforced Block-Out Vinyl
- ✓ Double Perimeter Hem For Strength
- ✓ Durable Bracket Sleeves Top / Bottom
- ✓ 2 Popular Banner Widths 30" & 36"
- ✓ 3 Popular Banner Lengths 60" 72" 96"
- ✓ 36" Widths Fits Our Bracket (page 67)

Printed vertical banners are priced standard with same imprint on two sides of white 12 ounce block-out vinyl. Sewn with sleeves to fit pole brackets up to 1" diameter. Sleeves are open at both ends and have brass grommets to secure banner to pole.

SUNBRELLA™ VERTICAL BANNERS (2 SIDED IMPRINT)

STYLE	SIZE	6-10	11-24	25-50	NET SETUP
SUB3060	30"x60"	\$169.99	\$163.69	\$149.99	\$65.00
2 nd color		\$33.00	\$33.00	\$33.00	\$25.50
SUB3072	30"x72"	\$209.86	\$203.99	\$189.99	\$65.00
2 nd color		\$36.00	\$36.00	\$36.00	\$25.50
SUB3096	30"x96"	\$279.80	\$273.99	\$259.99	\$65.00
2 nd color		\$39.00	\$39.00	\$39.00	\$25.50
SUB3672	36"x72"	\$253.86	\$249.99	\$239.99	\$65.00
2 nd color		\$39.00	\$39.00	\$39.00	\$25.50
SUB3696	36"x96"	\$336.76	\$330.99	\$313.99	\$65.00
2 nd color		\$43.00	\$43.00	\$43.00	\$25.50

- ✓ Acrylic Sunbrella™ Material
- ✓ Double Perimeter Hem For Strength
- ✓ Durable Bracket Sleeves Top / Bottom
- ✓ 2 Popular Banner Widths 30" & 36"
- ✓ 3 Popular Banner Lengths 60" 72" 96"
- ✓ 36" Widths Fits Our Bracket (page 67)

Printed vertical banners are priced standard with same imprint on two sides of dark colored Sunbrella™. Sewn with sleeves to fit pole brackets up to 1" diameter. Sleeves are open at both ends and have brass grommets to secure banner to pole.

Most dark colored Sunbrella™ can be printed on two sides using one piece of material. The above price is for printing on dark colored material using one piece.

18 OZ. REINFORCED VERTICAL VINYL BANNERS (2 SIDED IMPRINT)

STYLE	SIZE	6-10	11-24	25-50	NET SETUP
VUB3060-18	30"x60"	\$97.50	\$64.50	\$61.49	\$65.00
2 nd color		\$21.03	\$19.86	\$18.69	\$25.50
VUB3072-18	30"x72"	\$107.98	\$96.00	\$75.01	\$65.00
2 nd color		\$21.03	\$19.86	\$18.69	\$25.50
VUB3096-18	30"x96"	\$133.49	\$121.50	\$100.49	\$65.00
2 nd color		\$21.03	\$19.86	\$18.69	\$25.50
VUB3672-18	36"x72"	\$115.25	\$102.71	\$80.25	\$65.00
2 nd color		\$21.03	\$19.86	\$18.69	\$25.50
VUB3696-18	36"x96"	\$138.44	\$129.99	\$107.52	\$65.00
2 nd color		\$21.03	\$19.86	\$18.69	\$25.50

- ✓ 18oz Reinforced Block-Out Vinyl
- ✓ Double Perimeter Hem For Strength
- ✓ Durable Bracket Sleeves Top / Bottom
- ✓ 2 Heavy Duty Nylon Straps
- ✓ 2 Popular Banner Widths 30" & 96"
- ✓ 3 Popular Banner Lengths 60" 72" 96"
- ✓ 36" Widths Fits Our Bracket (page 67)

Printed vertical banners are priced standard with same imprint on two sides of white 18 ounce extra heavy duty block-out vinyl. Sewn with sleeves to fit pole brackets up to 1" diameter. Sleeves are open at both ends and have brass grommets to secure banner to pole.

NYLON VERTICAL BANNERS (2 SIDED IMPRINT)

STYLE	SIZE	6-10	11-24	25-50	NET SETUP
NUB3060	30"x60"	\$114.49	\$79.44	\$72.43	\$65.00
2 nd color		\$21.03	\$19.86	\$18.69	\$25.50
NUB3072	30"x72"	\$122.50	\$85.00	\$77.50	\$65.00
2 nd color		\$21.03	\$19.86	\$18.69	\$25.50
NUB3096	30"x96"	\$130.01	\$96.90	\$88.34	\$65.00
2 nd color		\$21.03	\$19.86	\$18.69	\$25.50
NUB3672	36"x72"	\$148.21	\$90.94	\$82.93	\$65.00
2 nd color		\$21.03	\$19.86	\$18.69	\$25.50
NUB3696	36"x96"	\$148.21	\$103.66	\$94.51	\$65.00
2 nd color		\$21.03	\$19.86	\$18.69	\$25.50

- ✓ 200 Denier Nylon
- ✓ Double Perimeter Hem For Strength
- ✓ Durable Bracket Sleeves Top / Bottom
- ✓ 2 Popular Banner Widths 30" & 36"
- ✓ 3 Popular Banner Lengths 60" 72" 96"
- ✓ 36" Widths Fits Our Bracket (page 67)

Printed vertical banners are priced standard with same imprint on two pieces of 200 Denier nylon. Sewn with sleeves to fit pole brackets up to 1" diameter. Sleeves are open at both ends and have brass grommets to secure banner to pole.



CUSTOM PRINTED PENNANT STRINGS

PRINTED VINYL PENNANT STRINGS

STYLE	COLORS	SIZE	5-15	16-50	51-100	101-250	NET SETUP
CPV30-1	1	30 FT.	\$28.25	\$26.60	\$24.50	\$21.99	\$45.00
CPV30-2	2	30 FT.	\$33.25	\$32.00	\$30.50	\$25.99	\$60.00
CPV30-3	3	30 FT.	\$43.00	\$41.38	\$39.80	\$34.99	\$90.00
CPV60-1	1	60 FT.	\$47.25	\$46.00	\$44.25	\$41.75	\$45.00
CPV60-2	2	60 FT.	\$52.50	\$50.50	\$47.50	\$44.35	\$60.00
CPV60-3	3	60 FT.	\$57.00	\$55.10	\$52.10	\$45.99	\$90.00
CPV100-1	1	100 FT.	\$61.00	\$58.00	\$56.99	\$55.99	\$45.00
CPV100-2	2	100 FT.	\$65.10	\$62.75	\$58.75	\$56.88	\$60.00
CPV100-3	3	100 FT.	\$69.99	\$66.99	\$65.00	\$64.00	\$90.00

* No setup charges on exact repeat orders. (Must order at least once every 12 months)

- ✓ 8 oz. Plastic-Coated Vinyl
- ✓ Large 12"x18" Triangle Panels
- ✓ Fluorescent or Standard Backgrounds
- ✓ Sag Resistant Brut-Lon™ Rope (black)
- ✓ White poly header tape
- ✓ Pennants Alternate Front & Back (or same side)

PRINTED POLY PENNANT STRINGS

STYLE	COLORS	SIZE	25-50	51-100	101-200	201-350	351-500	NET SETUP
CPP30-1	1	30 FT.	\$24.12	\$21.45	\$20.20	\$19.18	\$18.45	\$45.00
CPP30-2	2	30 FT.	\$26.99	\$23.78	\$22.59	\$21.99	\$19.88	\$60.00
CPP30-3	3	30 FT.	\$28.78	\$27.14	\$26.50	\$24.98	\$22.99	\$90.00
CPP60-1	1	60 FT.	\$35.00	\$33.45	\$30.78	\$29.50	\$28.18	\$45.00
CPP60-2	2	60 FT.	\$38.28	\$34.99	\$33.12	\$31.99	\$30.78	\$60.00
CPP60-3	3	60 FT.	\$43.00	\$40.45	\$39.19	\$37.99	\$36.39	\$90.00
CPP100-1	1	100 FT.	\$42.12	\$41.25	\$40.59	\$39.99	\$38.99	\$45.00
CPP100-2	2	100 FT.	\$44.12	\$43.79	\$42.50	\$41.80	\$40.99	\$60.00
CPP100-3	3	100 FT.	\$48.25	\$46.99	\$45.79	\$44.75	\$43.99	\$90.00

* No setup charges on exact repeat orders. (Must order at least once every 12 months)

- ✓ 4 Mil Polyethylene Plastic
- ✓ Large 12"x18" Triangle Panels
- ✓ 7 Popular Background Colors
- ✓ Pennants Alternate Front & Back
- ✓ White poly header tape
- ✓ Sag Resistant Brut-Lon™ Rope (black)

Quoted prices on pennants are for 12"x18" triangle only. All other sizes contact Sales Representative.



Multi-logos Available

30' = 12 Panels
60' = 24 Panels
100' = 48 Panels

BACKGROUNDS

STANDARD	FLUORESCENT
10 Red	1 Rocket Red
20 Orange	2 Blaze Orange
30 Yellow	3 Saturn Yellow
40 Green	4 Signal Green
5 Blue	8 Flame Pink
6 White	
7 Black	



DISCLAIMER: NAP is not affiliated with, sponsored by, licensed, or associated with any company. All company logos previewed herein are the registered marks of their respective companies and are for demonstration purposes only, to show examples of our graphics capabilities, of work done or what can be done. NAP only stocks raw materials. We do not premanufacture anything. We make only what you ask us to.

For 2 sided pennants, full bleeds, or rectangle panels please call for quote. If you do not specify sewing direction all pennants will be sewn facing the same direction.

CUSTOM PRINTED CORRUGATED PLASTIC

THESE CORRUGATED PLASTIC SIGNS ARE TOUGH ALL WEATHER SIGNS THAT CAN BE USED IN A WIDE VARIETY OF APPLICATIONS INCLUDING POLITICAL SIGNS, REAL ESTATE YARD SIGNS, PROPERTY MANAGEMENT SIGNS AND EVEN POLE SIGNS. PRINTED ON ONE OR TWO SIDES WITH LOW MINIMUM QUANTITIES AND SEVERAL HARDWARE MOUNTING OPTIONS TO CHOOSE FROM.

PRINTED CORRUGATED PLASTIC

STYLE	SIZE	6-10	11-15	16-24	25-50	51-100	101+
CPC624	6"x24"	\$11.25	\$5.32	\$4.91	\$4.50	\$4.10	\$3.67
2 nd color		\$2.33	\$2.33	\$2.33	\$2.33	\$2.33	\$2.33
CPC1218	12"x18"	\$19.81	\$14.07	\$13.66	\$13.26	\$12.85	\$12.49
2 nd color		\$3.21	\$3.21	\$3.21	\$3.21	\$3.21	\$3.21
CPC1824	18"x24"	\$21.27	\$17.59	\$17.28	\$16.78	\$16.27	\$15.57
2 nd color		\$3.21	\$3.21	\$3.21	\$3.21	\$3.21	\$3.21
CPC2424	24"x24"	\$21.57	\$19.26	\$18.68	\$18.13	\$17.53	\$17.06
2 nd color		\$3.21	\$3.21	\$3.21	\$3.21	\$3.21	\$3.21
CPC4848	48"x48"	\$52.79	\$50.45	\$49.86	\$49.28	\$48.70	\$47.96
2 nd color		\$4.10	\$4.10	\$4.10	\$4.10	\$4.10	\$4.10
CPC4896	48"x96"	\$111.82	\$111.61	\$108.26	\$95.27	\$86.70	\$80.64
2 nd color		\$5.84	\$5.84	\$5.84	\$5.84	\$5.84	\$5.84

- ✓ White Corrugated Plastic
- ✓ Finished With Grommets
- ✓ Printed 1 or 2 Sides
- ✓ Multi-Purpose Sign
- ✓ Printed or Vinyl Lettered

*See Artwork requirements on page 2

Price for custom printed plastic corrugated signs is for screen printing on one side and finished with or without grommets using UV resistant inks. Corrugated plastic comes in white, but may be available in several color choices for larger quantities. Please specify if flutes are vertical or horizontal. For most of our mounting hardware the flutes should run vertical.

Vinyl lettered message signs are text messages with block lettering on one side only. Finished with or without corner grommets.

SIGN HARDWARE

STYLE	SIZE	PRICE
WS01 - WOOD STAKE	3/8" x 1 1/2" x 48"	\$ 1.95
CPH05 - ROUND ROD H-FRAME	3/16" x 10 1/4" x 30"	\$ 1.95

* Mounting screws not included

VINYL LETTERED SIGNS

STYLE	SIZE	1-5	6-10	11+
CVC624	6"x24"	\$ 15.00	\$ 14.50	\$ 14.00
CVC1218	12"x18"	\$ 28.00	\$ 25.50	\$ 25.00
CVC1824	18"x24"	\$ 29.00	\$ 28.50	\$ 28.00
CVC2424	24"x24"	\$ 33.00	\$ 32.50	\$ 32.00

* For larger quantities call for written quote



Yard Ground H-Frame
(CPH05)

12"x18" Sign Face
30" Height
3/16" Rod
10 1/4" Width

Available
w/grommets too!



MAGNETIC & FLEET MARKERS

PRINTED MAGNETIC SIGNS

STYLE	SIZE	5-10	11-25	26-50	51+	NET SETUP
MAG618	6"x18"	\$25.12	\$18.58	\$13.56	\$11.33	\$50.00
2 nd color		\$3.51	\$3.51	\$3.51	\$3.51	\$25.00
MAG924	9"x24"	\$28.69	\$22.08	\$16.82	\$14.49	\$50.00
2 nd color		\$4.10	\$4.10	\$4.10	\$4.10	\$25.00
MAG1218	12"x18"	\$32.25	\$25.58	\$20.09	\$17.63	\$50.00
2 nd color		\$4.68	\$4.68	\$4.68	\$4.68	\$25.00
MAG1224	12"x24"	\$37.67	\$30.78	\$24.89	\$22.19	\$50.00
2 nd color		\$4.96	\$4.96	\$4.96	\$4.96	\$25.00
MAG1624	16"x24"	\$43.82	\$36.98	\$30.48	\$27.57	\$50.00
2 nd color		\$5.26	\$5.26	\$5.26	\$5.26	\$25.00
MAG2424	24"x24"	\$57.36	\$49.18	\$42.76	\$39.14	\$50.00
2 nd color		\$5.84	\$5.84	\$5.84	\$5.84	\$25.00
MAG2436	24"x36"	\$73.19	\$64.71	\$57.95	\$54.21	\$50.00
2 nd color		\$7.01	\$7.01	\$7.01	\$7.01	\$25.00

VINYL LETTERED MAGNETIC SIGNS

TEXT ONLY MESSAGE (NO LOGOS)

STYLE	SIZE	1 SET	2 SETS	3 SETS
VLMA1218	12"x18"	\$51.36	\$50.29	\$48.15
VLMA1224	12"x24"	\$55.64	\$54.57	\$52.43
VLMA1624	16"x24"	\$60.99	\$59.92	\$57.78
VLMA2424	24"x24"	\$67.41	\$66.34	\$64.20
VLMA2436	24"x36"	\$71.69	\$70.62	\$68.48

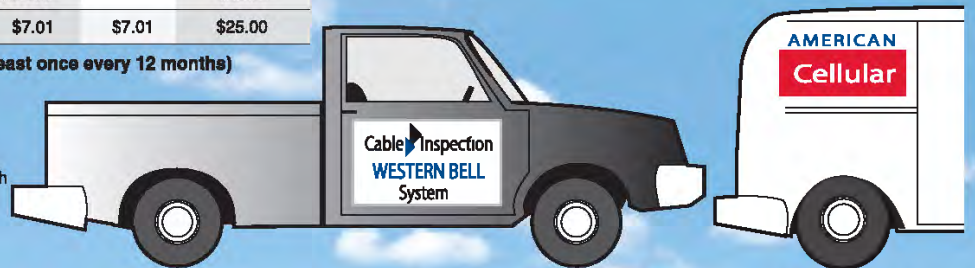
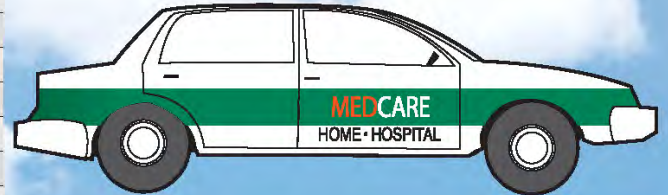

*No setup charges on exact repeat orders. (must order at least once every 12 months)

- ✓ .027 Thick White Magnetic Material
- ✓ 2 Per Set (5 Sets Minimum)
- ✓ Non-scratch Surface Keeps Vehicle Paint Safe
- ✓ Screen Printed & Vinyl Lettered
- ✓ Rounded Corners For Sleek Appearance & Also Reduces Wind Catch
- ✓ Perfect Sign For Pizza Couriers, Real Estate Agents & Anyone Who
- ✓ Uses Their Personal Automobile For Work

PRINTED VINYL FLEET MARKINGS

STYLE	SIZE	5-10	11-25	26-50	51+	NET SETUP
VM1218	12"x18"	\$11.40	\$6.33	\$7.11	\$5.00	\$50.00
2 nd color		\$5.38	\$5.38	\$5.38	\$5.38	\$25.00
VM23	2'x3'	\$18.08	\$16.05	\$13.60	\$11.18	\$50.00
2 nd color		\$5.70	\$5.70	\$5.70	\$5.70	\$25.00
VM26	2'x6'	\$24.22	\$20.89	\$17.85	\$16.72	\$50.00
2 nd color		\$6.05	\$6.05	\$6.05	\$6.05	\$25.00
VM35	3'x5'	\$30.29	\$24.48	\$22.10	\$20.90	\$50.00
2 nd color		\$6.05	\$6.05	\$6.05	\$6.05	\$25.00
VM38	3'x8'	\$48.46	\$38.69	\$35.35	\$33.42	\$50.00
2 nd color		\$6.37	\$6.37	\$6.37	\$6.37	\$25.00
VM310	3'x10'	\$52.22	\$43.34	\$39.22	\$35.52	\$50.00
2 nd color		\$6.37	\$6.37	\$6.37	\$6.37	\$25.00
VM315	3'x15'	\$70.09	\$64.41	\$59.54	\$57.11	\$50.00
2 nd color		\$6.72	\$6.72	\$6.72	\$6.72	\$25.00

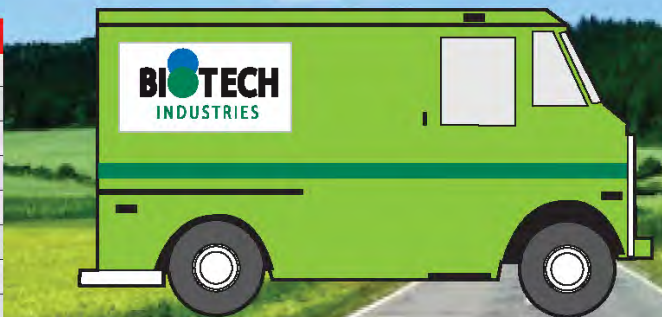

TEXT COLORS

- Black
- Red
- Yellow
- Blue
- Green

ASK US ABOUT
FULL COLOR
PRINTING!

*No setup charges on exact repeat orders. (must order at least once every 12 months)

- ✓ Commercial Quality Pressure Sensitive White Vinyl
- ✓ Low Minimum Quantities
- ✓ Large & Small Sizes Available
- ✓ Semi-Permanent Sign
- ✓ Easy To Apply
- ✓ This Product Is A Great Brand Exposure Tool
- ✓ Screened & Digitally Printed

CARS • VANS • PICK-UPS • TRUCK • TRAILERS



CUSTOM DIE CUT DECALS & WINDOW SIGNS

STOCK SIZES & SHAPES (DECALS)

STYLE	COLOR	125	250	500	1000	2500	5000	NET SETUP
DC 1-8	White	\$1.28	\$0.62	\$0.53	\$0.49	\$0.37	\$0.31	\$35.00
DC 1-8	Silver	\$1.28	\$0.62	\$0.53	\$0.49	\$0.37	\$0.31	\$35.00
DC 1-8	Gold	\$1.31	\$0.67	\$0.58	\$0.53	\$0.41	\$0.31	\$35.00
DC 1-8	Clear	\$1.03	\$0.66	\$0.50	\$0.42	\$0.35	\$0.31	\$35.00

* For multi-colored artwork or special die-cuts please call for written quote

CUSTOM SIZES & SHAPES (DECALS)

CUSTOM SIZES	125	250	500	1000	2500	5000	NET SETUP
1-10 Square Inches	\$2.24	\$1.42	\$0.98	\$0.65	\$0.42	\$0.37	\$35.00
11-20 Square Inches	\$2.82	\$1.70	\$1.14	\$0.77	\$0.52	\$0.41	\$35.00
21-30 Square Inches	\$3.11	\$1.88	\$1.33	\$0.84	\$0.55	\$0.47	\$35.00
31-60 Square Inches	\$3.36	\$2.14	\$1.52	\$0.96	\$0.71	\$0.59	\$35.00
61-100 Square Inches	\$3.94	\$2.53	\$1.88	\$1.30	\$0.98	\$0.84	\$35.00
101-125 Square Inches	\$4.39	\$2.75	\$1.99	\$1.58	\$1.30	\$1.13	\$35.00
126-150 Square Inches	\$4.80	\$2.93	\$2.23	\$1.85	\$1.51	\$1.33	\$45.00
151-175 Square Inches	\$5.08	\$3.31	\$2.58	\$2.24	\$1.98	\$1.80	\$45.00
176-200 Square Inches	\$5.52	\$3.68	\$3.07	\$2.65	\$2.35	\$2.22	\$45.00

* For multi-colored artwork or special die-cuts please call for written quote

Stock sizes & shapes include one standard size / shape from DC-1 to DC-8 styles on left side of page. Price includes printing 1 ink color on either a White, Silver, Gold, or Clear background color. Easy peel off backing. Commercial grade decal adhesive for strong bonds on nearly all smooth surfaces. Decal is not scored. Custom prices include your choice of White, Silver, Gold or Clear background colors. Rectangle or Square die-cuts. For other custom shapes please call for written quote.

* No setup charges on exact repeat orders. (must order at least once every 12 months)

CUSTOM PRINTED STATIC CLING WINDOW SIGNS

STYLE	SIZE	25-50	51-99	100	200	300	NET SETUP
SV1212	12"x12"	\$7.42	\$7.12	\$6.84	\$6.56	\$6.28	\$48.15
2 nd color		\$2.33	\$2.33	\$2.33	\$2.33	\$2.33	\$16.05
SV1218	12"x18"	\$7.93	\$7.61	\$7.31	\$7.01	\$6.69	\$48.15
2 nd color		\$2.33	\$2.33	\$2.33	\$2.33	\$2.33	\$16.05
SV1224	12"x24"	\$8.65	\$8.29	\$7.95	\$7.64	\$7.34	\$48.15
2 nd color		\$2.33	\$2.33	\$2.33	\$2.33	\$2.33	\$16.05
SV1818	18"x18"	\$9.43	\$8.78	\$8.42	\$7.82	\$7.48	\$48.15
2 nd color		\$2.33	\$2.33	\$2.33	\$2.33	\$2.33	\$16.05
SV1824	18"x24"	\$10.28	\$9.84	\$9.46	\$9.05	\$8.71	\$69.55
2 nd color		\$3.51	\$3.51	\$3.51	\$3.51	\$3.51	\$21.40
SV2424	24"x24"	\$11.20	\$10.75	\$10.31	\$9.90	\$9.51	\$69.55
2 nd color		\$3.51	\$3.51	\$3.51	\$3.51	\$3.51	\$21.40
SV2436	24"x36"	\$12.21	\$11.34	\$10.55	\$9.81	\$9.12	\$69.55
2 nd color		\$3.51	\$3.51	\$3.51	\$3.51	\$3.51	\$21.40
SV2448	24"x48"	\$13.31	\$12.39	\$11.51	\$10.70	\$9.96	\$69.55
2 nd color		\$3.51	\$3.51	\$3.51	\$3.51	\$3.51	\$21.40
SV3636	36"x36"	\$14.87	\$13.63	\$12.68	\$11.74	\$10.98	\$69.55
2 nd color		\$3.51	\$3.51	\$3.51	\$3.51	\$3.51	\$26.75
SV3648	36"x48"	\$16.01	\$14.89	\$13.84	\$12.86	\$11.98	\$69.55
2 nd color		\$3.51	\$3.51	\$3.51	\$3.51	\$3.51	\$26.75
SV3660	36"x60"	\$17.09	\$15.89	\$14.78	\$13.74	\$12.79	\$69.55
2 nd color		\$3.51	\$3.51	\$3.51	\$3.51	\$3.51	\$26.75

Price includes printing on 4 mil clear permanent adhesive vinyl material. Specify indoor or outdoor application when ordering. Adhesive vinyl can be used on automobile windows, restaurant windows and like glass.

For custom sizes or intricate 4 color process artwork please call factory for written quotation.



DC-1 2"x2" Square



DC-2 1 3/4"x3 3/4" Small Oval



DC-3 3"x3" Triangle



DC-4 1 3/4"x3 3/4" Rectangle



DC-5 2 1/2" Dia. Round



DC-6 2"x2" Square



DC-8 1 3/4"x3 3/4" Rectangle



DC-7 1 1/2"x5" Large Oval

AUTOMOTIVE SPECIALTY FLAGS & PENNANTS

3' x 3' CHECKERED FLAGS

STYLE	1-4	5-10	11-15	16+
CR	\$27.50	\$26.95	\$26.13	\$25.58

Pole is 5/8" x 48" Wood Dowel - Sleeve Fits 5/8" pole.

Pole Sleeve	\$6.90
Pole	\$3.50

- ✓ 200 Denier Nylon
- ✓ Reinforced Fly End
- ✓ Four Rows Of Stitching
- ✓ Strong Canvas Heading
- ✓ Two Brass Grommets
- ✓ Screen Printed
- ✓ Poly Bagged



CR 1 Blk, White



CR 2 Blue, White

3' x 3' RACE TRACK FLAGS

STYLE	1-4	5-10	11-15	16+
RT	\$30.80	\$30.25	\$29.70	\$29.43
RF SET	\$184.80	\$165.00	\$145.20	\$141.36

RF SET Comes with all seven race track flags and includes seven 5/8" x 48" wood poles. RT is for individual flags only.

- ✓ 200 Denier Nylon
- ✓ Reinforced Fly End
- ✓ Four Rows Of Stitching
- ✓ Pole Sleeve (5/8" pole)
- ✓ 5/8" x 48" Wood Pole
- ✓ Screen Printed



CR 3 Red, White



CR 4 Green, White



CR 5 Orange, White

Flexographic printed pennants are for short term use only, and should be used in dry areas. Ideal for weekend applications or a few days at the races.

3' X 3' CHECKERED PENNANT STRINGS

STYLE	1-4	5-10	11-15	16+
CP1 & CPS1-30FT	\$6.60	\$6.33	\$6.05	\$5.78
CP1 & CPS1-60FT	\$12.10	\$11.55	\$11.00	\$10.73
CP1 & CPS1-105FT	\$19.80	\$19.25	\$18.70	\$18.43
CP2 & CPS2-30FT	\$6.60	\$6.33	\$6.05	\$5.78
CP2 & CPS2-60FT	\$12.10	\$11.55	\$11.00	\$10.73
CP2 & CPS2-105FT	\$19.80	\$19.25	\$18.70	\$18.43

- ✓ 4 Mil Clear Polyethylene Panels
- ✓ Flexographic Imprinting On One Side
- ✓ Print Shows Through To Backside
- ✓ Sewn With White 4 Mil Poly Tape
- ✓ Available In Red or Black Checks
- ✓ Available In Triangle & Rectangle Panels
- ✓ Approximately 5 Foot Of Rope Tie Per



RT 1 Finish



RT 2 Final Lap

STYLE	SIZE	SHAPE	30 FT	60 FT	105 FT
CP1 / CP2	12"x18"	Triangle	12 Panels	24 Panels	48 Panels
CPS1 / CPS2	9"x12"	Rectangle	15 Panels	30 Panels	60 Panels



RT 3 Caution

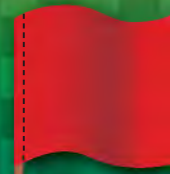

RT 4 Stop



RT 5 Move To Outside



RT 6 Leave Track



RT 7 Start



RT 8 Red Cross



CP1
12"x18"
TRIANGLE FLAG

CPS1
CPS2
9"x12"
RECTANGLE FLAG

CPS1

CP1

CPS2

CP2



A

DEALER LOGO & FRANCHISE FLAGS

200 DENIER NYLON DEALER LOGO FLAGS

STYLE	1-10	11-15	16-30	31-50
DF - 1 Sided - 3'X5'	\$41.00	\$40.25	\$37.50	\$37.00
DF - 2 Sided - 3'X5'	\$73.80	\$72.45	\$67.50	\$66.60
DF - 1 Sided - 2.5'X3.5'	\$30.90	\$29.50	\$28.50	\$27.25
DF - 2 Sided - 2.5'X3.5'	\$15.50	\$59.00	\$57.00	\$54.50

200 DENIER NYLON FRANCHISE LOGO FLAGS

STYLE	1-10	11-15	16-25	31-50
FFF/OCF - 1 Sided - 3'X5'	\$41.00	\$40.25	\$37.50	\$37.00
FFF/OCF - 2 Sided - 3'X5'	\$73.80	\$72.45	\$67.50	\$66.60
FFF/OCF - 1 Sided - 2.5'X3.5'	\$30.90	\$29.50	\$28.50	\$27.25
FFF/OCF - 2 Sided - 2.5'X3.5'	\$15.50	\$59.00	\$57.00	\$54.50
CHK - 3'X5'	\$41.00	\$40.25	\$37.50	\$37.00
CHK - 2.5'X3.5'	\$30.90	\$29.50	\$28.50	\$27.25

* OTHER LOGOS AVAILABLE



DF 1



DF 6



DF Custom



DF 24



DF 50



DF 52



DF 53

DISCLAIMER: NAP is not affiliated with, sponsored by, licensed, or associated with any company. All company logos previewed herein are the registered marks of their respective companies and are for demonstration purposes only, to show examples of our graphics capabilities, of work done or what can be done. NAP only stocks raw materials. We do not premanufacture anything. We make only what you ask us to. * 20% surcharge on this flag



FFF1



FFF2



FFF3



FFF4



FFF5



FFF6



FFF7



FFF8



FFF9



FFF10

* Pole Sleeve	\$7.15
---------------	--------

* Sleeve is closed at top and fits a 3/4" pole.

- ✓ 200 Denier Nylon
- ✓ Reinforced Fly Ends
- ✓ Heading with Brass Grommets
- ✓ 1 Sided Flags Reads Reverse On Back
- ✓ 2 Sided Flags Reads Correct On Both Sides
- ✓ Screen Printed (Gradient Logos Are Digitally Printed)

CLUSTER FLAG KITS FOR STYLE DF -FFF-OCF -CHK

STYLE	1-10	11-15	16-25
CFK	\$235.00	\$199.99	\$189.99

KIT INCLUDES:

- 3 Flags (3'x5')
- 2 Adjustable Steel Bands
- 3 Poles 3/4"x5'
- 3 Brackets



Pole hardware on page 67



OCF 1



OCF 2



OCF 3



OCF 4



OCF 5



OCF 6



OCF 7



OCF 8



OCF 9



OCF 10



OCF 11



OCF 12



OCF 13



OCF 14



OCF 15



OCF 16



OCF 17



OCF 19



OCF 20



CHK-B



CHK-R



OCF 3R



3 STRIPE DEALER & MESSAGE FLAGS

3'x5' - 200 DENIER NYLON DEALER LOGO FLAGS

STYLE	1-10	11-15	16-30	31-50
SDF - 1 Sided	\$33.00	\$32.50	\$32.00	\$31.75
SDF - 2 Sided	\$59.40	\$57.60	\$57.00	\$56.40

3'x5' - 200 DENIER NYLON MESSAGE FLAGS

STYLE	1-10	11-15	16-30	31-50
PNF - 1 Sided	\$33.00	\$32.50	\$32.00	\$31.75
PNF - 2 Sided	\$59.40	\$57.60	\$57.00	\$56.40

3'x5' - 200 DENIER NYLON CUSTOM MESSAGE FLAGS

STYLE	6-10	11-15	16-25	25+
PNFC - 1 Sided	\$40.99	\$40.07	\$39.17	\$38.25
PNFC - 2 Sided	\$61.49	\$60.10	\$58.76	\$57.38

* OTHER LOGOS AVAILABLE



SDF 1



SDF 6



SDF 24



SDF 50



SDF 52



SDF 53

DISCLAIMER: NAP is not affiliated with, sponsored by, licensed, or associated with any company. All company logos previewed herein are the registered marks of their respective companies and are for demonstration purposes only, to show examples of our graphics capabilities, of work done or what can be done. NAP only stocks raw materials. We do not premanufacture anything. We make only what you ask us to.

Free Set-Up

* Pole Sleeve	\$7.15
---------------	--------



* Check Panels	\$13.20
----------------	---------



* Specify Styles BC or RC For Top & Bottom Check Panels

* Sleeve is closed at top and fits a 3/4" pole.

OPTIONAL TOP & BOTTOM PANEL COLORS* FREE

1 OG Red	2 Orange
3 Spanish Yellow	4 Emerald Green
5 OG Blue	7 Black
8 Spice Brown	9 Royal Blue

- ✓ 200 Denier Nylon
- ✓ Reinforced Fly Ends
- ✓ 4 Rows Of Stitching
- ✓ Strong Canvas Heading
- ✓ Two Brass Grommets Mounted To Heading
- ✓ 1 Sided Flag Reads Reverse On Back Side
- ✓ Many Stock Logos To Choose From
- ✓ Screen Printed (Gradient dealer logos digitally printed)
- ✓ Flag can be used with Cluster Hardware (requires sleeve)
- ✓ 1 Sided Flag Printed on Center White Panel
- ✓ 2 Sided Flag Printed on Center White Panel



PNF10



PNF11



PNF12



PNF89



PNF90



PNF15



PNF16



PNF18



PNF92



PNF20



PNF57



PNF58



PNF91



PNF61



PNF62



PNF93



PNF64



PNF65



PNF93



PNF68



PNF69



PNF70



PNF71



PNF73



PNF74



PNF75



PNF76



PNF77



PNF78



PNF79



PNF80



PNF81



PNF82



PNF83



PNF84



PNF85

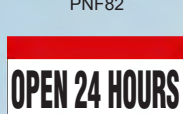

PNF86



PNF87



PNF88



PNF89



PNF100 (Spanish Spoken Here)



PNF101 (Sale)



PNF102 (Used Cars)



PNF103 (Welcome)



PNF104 (New Cars)



PNF105 (Open)



PNF106 (Buy Here)



PNF107 (Pay Here)



PNF108 (Specials)



PNF109 (Low Prices)



PNF110 (Save)



PNF111 (Open Sunday)

3 STRIPE DEALER LOGO DRAPES



DVF 62

DVF 24

3'x8' - 200 DENIER NYLON - 1 OR 2 SIDED DRAPES

STYLE	1-10	11-15	16-30	31-50
DVF -1 Sided	\$59.50	\$57.50	\$57.00	\$56.00
DVF -2 Sided	\$95.20	\$92.00	\$91.20	\$89.60
UB - Sleeves*	\$8.00	\$8.00	\$8.00	\$8.00

*Sleeves fit 1" Bracket

- ✓ 200 Denier Nylon
- ✓ Reinforced Fly Ends
- ✓ Sewn with header & Grommets
- ✓ 1 Sided reads correctly on front - mirrored on black (nylon only)
- ✓ 2 Sided reads correctly both sides
- ✓ Gradient logo designs on nylon are digitally printed
- ✓ Standard spot color logos are screen printed

3'x8' - 16OZ. REINFORCED VINYL - 2 SIDED DRAPES

STYLE	1-10	11-15	16-30	31-50
DVF- 162S	\$102.50	\$100.00	\$97.50	\$96.00
DDS - 162S	\$102.50	\$100.00	\$97.50	\$96.00

3'x8' - 18OZ. REINFORCED VINYL - 2 SIDED DRAPES

STYLE	1-10	11-15	16-24	25+
DVF-182S	\$106.00	\$103.50	\$99.75	\$97.75
DDS -182S	\$106.00	\$103.50	\$99.75	\$97.75

- ✓ 16oz. or 18oz. reinforced white vinyl
- ✓ Reads Correctly On Both Sides
- ✓ Sleeves top & bottom to fit 1" pole brackets
- ✓ Brass grommets on vertical pole side top/bottom of sleeves
- ✓ Digitally printed with UV inks

Specify Drape Style Number + Logo Number When Ordering

DISCLAIMER: NAP is not affiliated with, sponsored by, licensed, or associated with any company. All company logos previewed herein are the registered marks of their respective companies and are for demonstration purposes only, to show examples of our graphics capabilities, of work done or what can be done. NAP only stocks raw materials. We do not premanufacture anything. We make only what you ask us to.

Nylon Sewn Standard w/ Header & Grommets
Vinyl Sewn Standard w/ Sleeves Top & Bottom



DVF 53

SVF 53

Pole Brackets on page

67

* OTHER LOGOS AVAILABLE

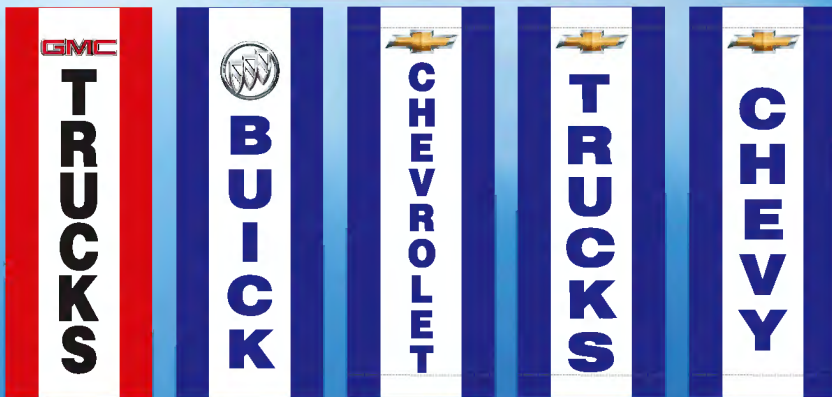

DVF 6

DVF 15

DVF 62

DVF 24

DVF 62

3 STRIPE MESSAGE DRAPES



SV 3

Nylon Sewn Standard w/ Header & Grommets
Vinyl Sewn Standard w/ Sleeves Top & Bottom

OPTIONAL OUTSIDE PANEL COLORS* FREE



3'x8' - 200 DENIER NYLON - 1 OR 2 SIDED DRAPES

STYLE	1-10	11-15	16-30	31-50
SV - 1 Sided	\$51.50	\$50.00	\$49.50	\$48.75
SV - 2 Sided	\$82.40	\$81.50	\$80.00	\$78.90
UB - Sleeves*	\$8.00	\$8.00	\$8.00	\$8.00

- ✓ 200 Denier Nylon
- ✓ Reinforced Fly Ends
- ✓ Sewn with header & Grommets
- ✓ 1 Sided reads correctly on front - mirrored on black (nylon only)
- ✓ 2 Sided reads correctly both sides
- ✓ Ceter Pannel D/F 2 Sided

*Sleeves fit 1" Bracket

3'x8' - 16OZ. REINFORCED VINYL - 2 SIDED DRAPES

STYLE	1-10	11-15	16-30	31-50
SV - 162S	\$102.50	\$100.00	\$97.50	\$96.00

3'x8' - 18OZ. REINFORCED VINYL - 2 SIDED DRAPES

STYLE	1-10	11-15	16-30	31-50
SV - 182S	\$106.00	\$103.50	\$99.75	\$97.95

- ✓ 16oz. or 18oz. reinforced white vinyl
- ✓ Reads Correctly On Both Sides
- ✓ Sleeves top & bottom to fit 1" pole brackets
- ✓ Brass grommet on vertical pole side top/bottom of sleeves
- ✓ Digitally printed with UV inks

Message drapes on this page are available in either vinyl or nylon. On nylon the message is printed 1 or 2 sides on center white panel and sewn with outside nylon panels (specify your color choice when ordering) Nylon drapes come standard with header and grommets but can also be ordered with pole bracket sleeves. Vinyl drapes are printed standard on both sides and include bracket sleeves.



SV 1



SV 2



SV 20



SV 4



SV 5



SV 6



SV 7



SV 8



SV 9



SV 10



SV 11



SV 12



SV 13



SV 14



SV 15



SV 16



SV 17



SV 18



SV 19



SV-50
(Spanish Spoken Here)



SVSP-1 (Sale)



SV 51
(Used Cars)



SV 52
(Welcome)



SV 53
(New Cars)



SV 54
(Open)

Pole Brackets on page

67

SPECIFY DRAPE STYLE NUMBER + MESSAGE NUMBER WHEN ORDERING

DEALER LOGO & MESSAGE BRACKET FLAGS

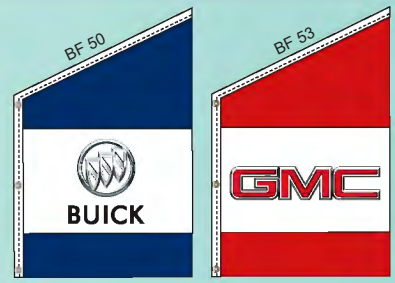
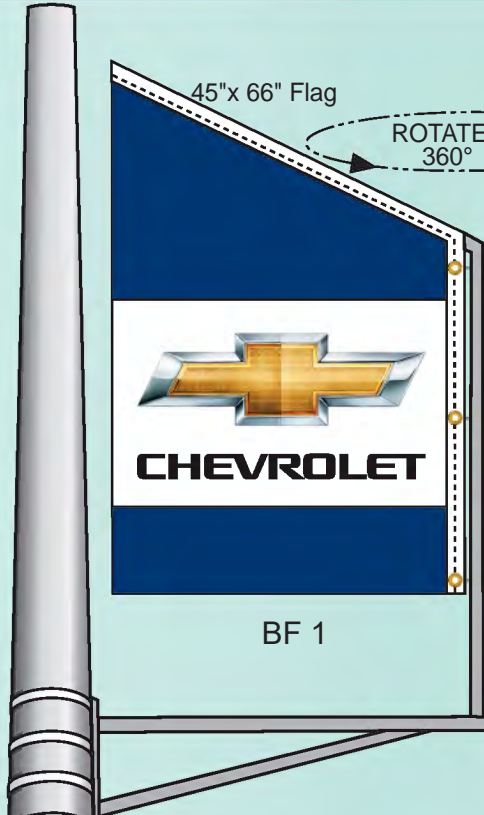

*OTHER LOGOS AVAILABLE

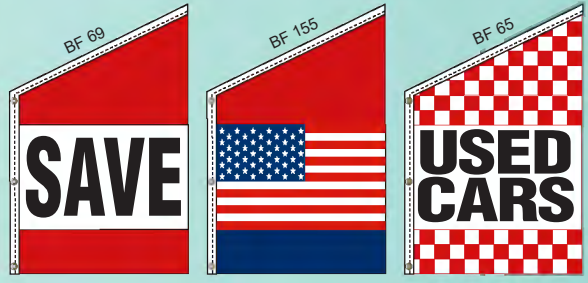
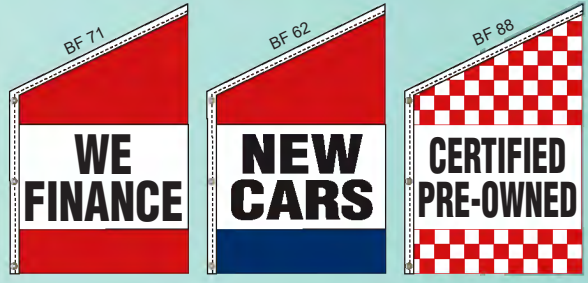
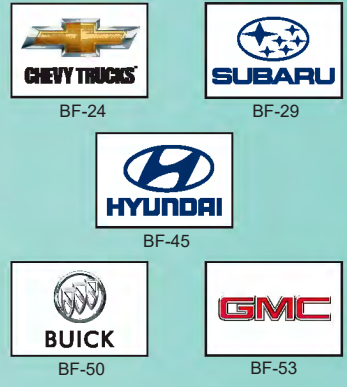

DISCLAIMER: NAP is not affiliated with, sponsored by, licensed, or associated with any company. All company logos previewed herein are the registered marks of their respective companies and are for demonstration purposes only, to show examples of our graphics capabilities, of work done or what can be done. NAP only stocks raw materials. We do not premanufacture anything. We make only what you ask us to.

Bracket flags on this page are printed on center white panels. Two sided flags read correctly on both sides while, one sided flags have logo or message mirrored on back side. Custom printed bracket flags are available with imprint on center white panel or entire length of flag. Call for pricing on full paneled imprints or multi colored designs. All bracket flags are sewn for our rotating bracket system. Intricate or multi colored artwork designs will be digitally printed.

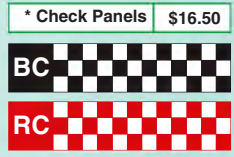

45"X66" - 200 DENIER NYLON - 1 OR 2 SIDED STOCK

STYLE	1-10	11-15	16-30	31-50
BF 1 Sided	\$48.50	\$47.00	\$46.50	\$45.00
BF 2 Sided	\$84.50	\$83.00	\$82.00	\$80.00

45"X66" - 200 DENIER NYLON - 1 SIDED CUSTOM

STYLE	6-10	11-15	16-30	31-50
BFC1S	\$76.00	\$64.00	\$59.00	\$56.00

45"X66" - 200 DENIER NYLON - 2 SIDED CUSTOM

STYLE	6-10	11-15	16-24	31-50
BFC2S	\$114.00	\$96.00	\$88.50	\$84.25

- ✓ 1 Sided Reads Correctly on Front Mirrored on Back
- ✓ 2 Sided Reads Correctly on Both Sides
- ✓ Made for use with our Bracket Flag Bracket

Imprinted on center panel
Call for pricing on multi-colored or full paneled artwork designs
2 Sided bracket flags are printed on center white panel

STYLE	1-10	11-15	16-24	25+
BF Bracket	\$90.00	\$87.00	\$86.00	\$83.00

Specify Dealer Logo or Item Number When Ordering.
Specify top and bottom panel colors when ordering.



3 PANEL DEALER LOGO & MESSAGE STACKS

*OTHER LOGOS AVAILABLE



DS-1



DS-15



DS-24



DS-53



**Vinyl Lasts
50%
Longer**



DS1-61



DS1-65



DS1-57



DS1-100



DS1-99



DS1-63



DS1-75



DS1-80



DS1-71



DS1-81



DS1-74



DS1-82



DS1-83



DS1-56



DS1-84



DS1-75



DS1-86



DS1-62



DS1-58



DS1-87



DS1-88



DS1-89



DS1-69



DS1-90



DS1-91

3.5'X7.5' - 200 DENIER NYLON - 1 OR 2 SIDED STACK

STYLE	1-10	11-15	16-30	31-50
DS1 - 1 Sided	\$62.00	\$58.50	\$56.99	\$55.25
DS1 - 2 Sided	\$99.00	\$94.50	\$91.99	\$90.00
UB - Sleeves*	\$9.00	\$9.00	\$9.00	\$9.00

*Sleeves fit 1" Diameter By 42" Bracket

- ✓ 200 Denier Nylon
- ✓ Reinforced Fly Ends
- ✓ Sewn with header & Grommets
- ✓ 1 Sided reads-correctly on front - mirrored on black (nylon only)
- ✓ 2 Sided reads-correctly both sides
- ✓ 2 Sided Center Only

3.5'X7.5' - 16OZ. REINFORCED VINYL - 2 SIDED STACK

STYLE	1-10	11-15	16-30	31-50
DS1-162S	\$106.99	\$103.50	\$99.99	\$96.79

3.5'X7.5' - 18OZ. REINFORCED VINYL - 2 SIDED STACK

STYLE	1-10	11-15	16-30	31-50
DS1-182S	\$109.58	\$106.78	\$103.78	\$99.99

- ✓ 16oz. or 18oz. Reinforced white vinyl
- ✓ Reads-Correctly On Both Sides
- ✓ Sleeves top & bottom to fit 1" pole brackets
- ✓ Brass grommets on vertical pole side top/bottom of sleeves
- ✓ Digitally printed with UV inks

Specify Drape Style Number + Message or Logo Number When Ordering



DS1-92



DS1-93

Nylon Sewn Standard w/ Header & Grommets
Vinyl Sewn Standard w/ Sleeves Top & Bottom

* Check Panels \$12.50



OPTIONAL TOP & BOTTOM PANEL COLORS* FREE

- | | | | |
|-----------------|-------------------------|------------------|----------------------|
| 1 OG Red | 3 Spanish Yellow | 5 OG Blue | 9 Royal Blue |
| 2 Orange | 4 Emerald Green | 7 Black | 8 Spice Brown |



5 PANEL DEALER LOGO & MESSAGE STACKS

3.5'x12' - 200 DENIER NYLON - 1 OR 2 SIDED STACK

STYLE	1-10	11-15	16-24	25+
DS2 - 1 Sided	\$107.95	\$106.65	\$105.40	\$104.75
DS2 - 2 Sided	\$205.10	\$202.65	\$200.10	\$199.00
UB - Sleeves*	\$9.00	\$9.00	\$9.00	\$9.00

*Sleeves fit 1" Diameter By 42" Bracket

- ✓ 200 Denier Nylon
- ✓ Reinforced Fly Ends
- ✓ Sewn with header & Grommets
- ✓ 1 Sided reads- correctly on front - mirrored on black (nylon only)
- ✓ 2 Sided reads- correctly both sides

Specify Drape Style
Number + Message or Logo
Number When Ordering

* Check Panels \$13.75



*OTHER LOGOS AVAILABLE



DS-1



DS-15



DS-24



DS-53

DISCLAIMER: NAP is not affiliated with, sponsored by, licensed, or associated with any company. All company logos previewed herein are the registered marks of their respective companies and are for demonstration purposes only, to show examples of our graphics capabilities, of work done or what can be done. NAP only stocks raw materials. We do not premanufacture anything. We make only what you ask us to.



Any
Authorized
Logo Here

Above combinations are examples only

Mix and Match logos or logos with text messages for each of the two white panels. Specify desired panel colors for 1st, 3rd & 5th panels only.



DS2-93



DS2-92

NYLON SEWN STANDARD W/ HEADER & GROMMETS

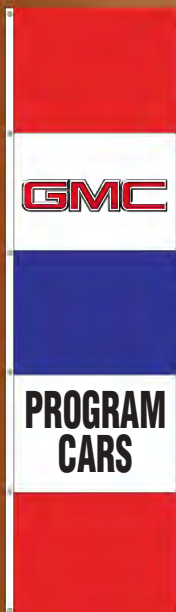

DS2-61



DS2-65



DS2-57



DS2-63



DS2-75



DS2-80



DS2-71



DS2-81



Above combinations are examples only



DS2-74



DS2-82



DS2-83



DS2-56



DS2-84



DS2-75



DS2-86



DS2-62



DS2-58



DS2-87



DS2-88



DS2-89



DS2-69



DS2-90



DS2-91

OPTIONAL TOP & BOTTOM PANEL COLORS* FREE

1 OG Red

3 Spanish Yellow

5 OG Blue

9 Royal Blue

2 Orange

4 Emerald Green

7 Black

8 Spice Brown

ABOVE COMBINATIONS ARE EXAMPLES ONLY

UNIVERSAL BRACKET BANNERS

3'x8' - VINYL POLE BANNER SETS - STYLE 1 TO 22

VINYL WEIGHT	1-5	6-10	11-15	16-30	31-50
16oz. - Good	\$199.99	\$190.99	\$187.99	\$181.50	\$176.99
18oz. - Better	\$208.99	\$206.99	\$193.00	\$185.99	\$180.50
Nylon	\$242.99	\$239.50	\$236.75	\$231.99	\$228.99

Price is for a two banner set

3'x8' - VINYL POLE BANNER SETS - STYLE A TO L

VINYL WEIGHT	1-5	6-10	11-15	16-30	31-50
16oz. - Good	\$199.99	\$190.99	\$187.99	\$181.50	\$176.99
18oz. - Better	\$208.99	\$206.99	\$193.00	\$185.99	\$180.50

Price is for a two banner set

SPECIFY MESSAGE STYLE NUMBER + COLOR CODE WHEN ORDERING STYLE 1 TO 22

CODE	LEFT SIDE COLOR	RIGHT SIDE COLOR	
BR	Blue Background	Red Background	Wht. Text
RB	Red Background	Blue Background	Wht. Text
RR	Red Background	Red Background	Wht. Text
BB	Blue Background	Blue Background	Wht. Text
YK	Yellow Background	Black Background	Blk & Yell. Text
KY	Black Background	Yellow Background	Yell. & Blk Text
YY	Yellow Background	Yellow Background	Black Text
KK	Black Background	Black Background	Yellow Text

3'x8' - VINYL POLE BANNER (SINGLE) CUSTOM DESIGNS

VINYL WEIGHT	1-5	6-10	11-15	16-30	31-50
16oz. - Single	\$136.75	\$130.50	\$125.90	\$120.80	\$116.75
18oz. - Single	\$141.99	\$138.50	\$135.25	\$131.78	\$128.88

* Same artwork design both sided of single banner

3'x8' - VINYL POLE BANNER (DOUBLE) CUSTOM DESIGNS

VINYL WEIGHT	1-5	6-10	11-15	16-30	31-50
16oz. - Double	\$261.50	\$252.99	\$248.88	\$238.99	\$235.55
18oz. - Double	\$271.20	\$259.99	\$253.78	\$249.99	\$245.79

* One or Two artwork designs - common to both sides or alternating front/back - front/ back



Pole Brackets on page

67



AUTOMOTIVE UB DEALER LOGO BANNERS

*OTHER LOGOS AVAILABLE



UBDSDF-01

UBDSDF-09

UBDSDF-10

UBDSDF-08

UBDSDF-07



UBDSDF - Custom



(Example)

Pole Brackets on page 67

- ✓ All pole banners read correctly on both sides
- ✓ Heavy reinforced vinyl's - choose from two weight classes
- ✓ Digitally printed with UV resistant inks
- ✓ Reinforced sleeves for extra durability
- ✓ Brass grommets on sleeves & vertical pole side
- ✓ Fits any standard 2 sided bracket with up to 1" diameter arms



DISCLAIMER: NAP is not affiliated with, sponsored by, licensed, or associated with any company. All company logos previewed herein are the registered marks of their respective companies and are for demonstration purposes only, to show examples of our graphics capabilities, of work done or what can be done. NAP only stocks raw materials. We do not premanufacture anything. We make only what you ask us to.

DEALER & MESSAGE PENNANT STRINGS

*OTHER LOGOS AVAILABLE

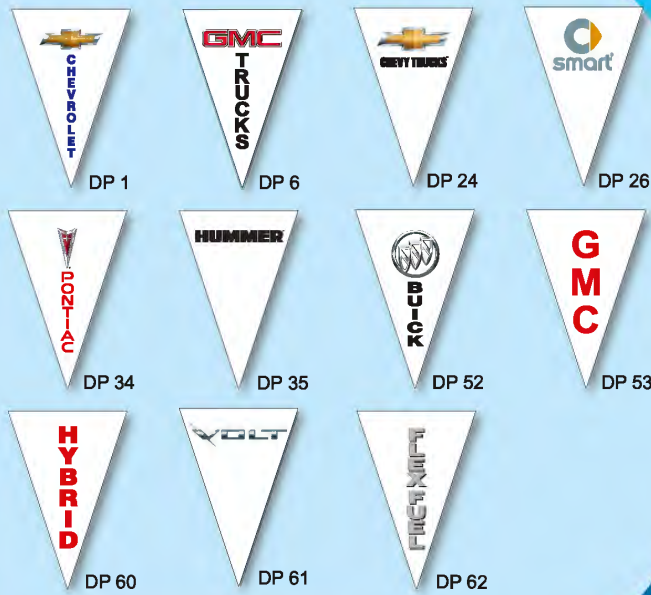

BLACK PRINT WITH WHITE OR FLUORESCENT ORANGE BACKGROUND

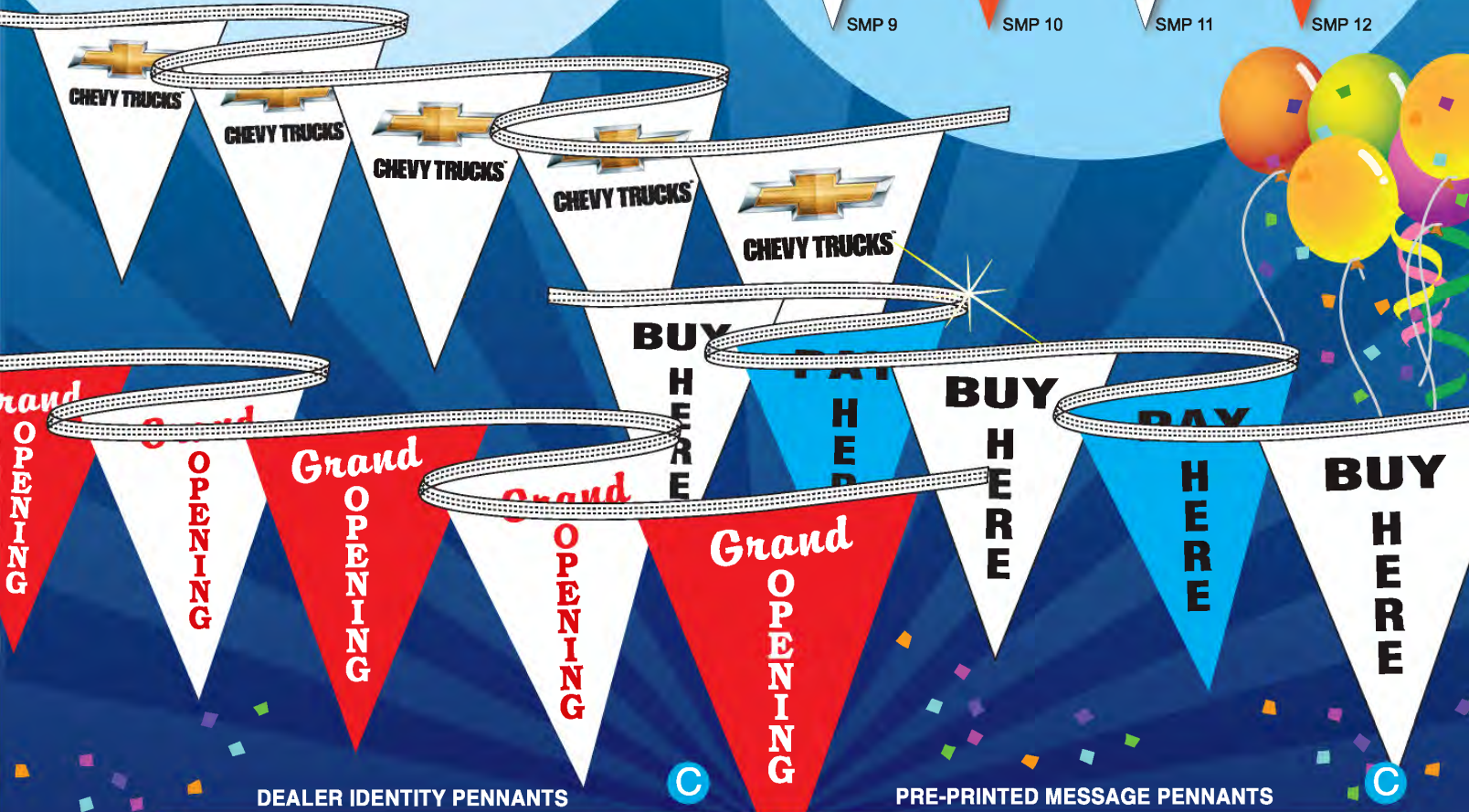
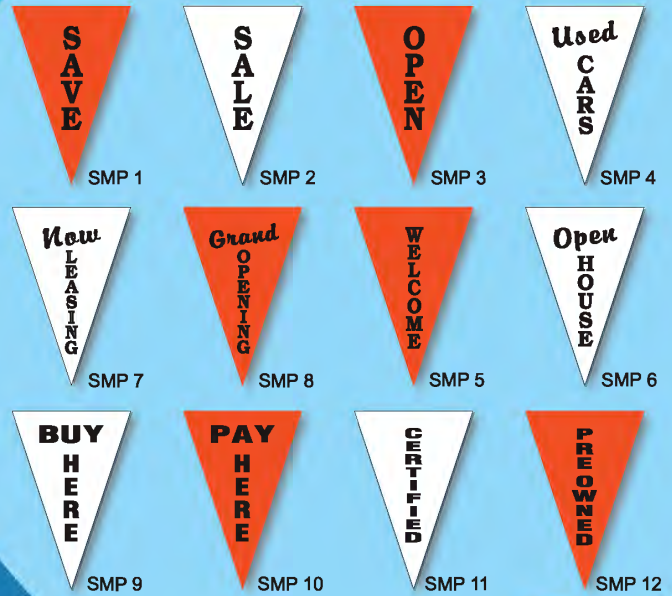

DEALER IDENTITY PENNANTS

STYLE	LENGTH	COLOR	1-10	11-24	25+
DP	30 FT	White Only	\$31.95	\$27.70	\$26.80
DP	60 FT	White Only	\$42.84	\$42.24	\$41.64

*Not restockable

ORDER EXAMPLE:	DP 1
Logo Pattern:	Chevrolet
ORDER EXAMPLE:	DP 1-24
Logo Pattern:	Chevy+Chevy Trucks

- ✓ 8oz Plastic-Cloth Vinyl Material
- ✓ BIG 12"x18" Triangle Panels
- ✓ Printed 1 Side
- ✓ Faces Alternate Front & Back
- ✓ May Combine Multi-Logos
- ✓ Sag Resistant Brut-Lon Rope™
- ✓ White Poly Tape
- ✓ Screen Printed

PRE-PRINTED MESSAGE PENNANTS

STYLE	LENGTH	COLOR	1-10	11-24	25+
SMP-W	30 FT	White Back	\$31.36	\$30.71	\$30.07
SMP-O	30 FT	Orange Back	\$31.36	\$30.71	\$30.07
SMP-W	60 FT	White Back	\$45.49	\$44.84	\$44.20
SMP-O	60 FT	Orange Back	\$45.49	\$44.84	\$44.20

Printed in black ink on either orange or white background must specify when ordering.

ORDER EXAMPLE:	SMP-W 2
Message:	Sale
Background Color:	White

ORDER EXAMPLE:	SMP-O 8-2
Message:	Grand Opening + Sale
Background Color:	Orange

WARNING FLAGS & PRICE SLOGANS

FLUORESCENT WARNING FLAGS

STYLE	COLOR	1-10	11-15	16-24	25+
WFO	ORANGE	\$8.90	\$8.79	\$8.67	\$8.54
WFR	RED	\$8.90	\$8.79	\$8.67	\$8.54

- ✓ 8oz Fluorescent Vinyl Sleeve For 3/4" Pole
- ✓ 3/4"x48" Pole Included
- ✓ 18"x18" Warning Flags

These highly visible warning flags come in bright fluorescent Orange or fluorescent Red. Mounted to 5/8" x 36" wooden dowel. Great for stopping or slowing traffic. Install next to danger spots.

FLUORESCENT WARNING MARKERS

STYLE	COLOR	1-10	11-15	16-24	25+
LM10	ORANGE	\$9.00	\$8.50	\$8.25	\$7.80
LM1R	RED	\$9.00	\$8.50	\$8.25	\$7.80
LM10	ORANGE	\$10.00	\$9.75	\$9.50	\$9.10
LM1R	RED	\$10.00	\$9.75	\$9.50	\$9.10

- ✓ 8oz Fluorescent Vinyl
- ✓ 1 Brass Grommet
- ✓ Printed & Non-Printed
- ✓ Printed 1 Side Only
- ✓ Ideal For Large Loads
- ✓ Optional Customizing
- ✓ Reads DANGER
- ✓ 2 Sided Flag Available
- ✓ 18"x18" Warning Markers

These highly visible warning flags come in bright fluorescent Orange or fluorescent Red. Finished with corner grommet. Available in both printed (Danger) and blank. For order of 100 or more you may select your own message.

AUTOMOTIVE PRICE STICKERS & MESSAGE SLOGANS

STYLE	1-10 DZ	11-25 DZ	26-50 DZ	51-100 DZ	101+ DZ
SPS 1-28	\$11.00	\$10.50	\$10.00	\$9.50	\$9.00
SPS A-K	\$11.00	\$10.50	\$10.00	\$9.50	\$9.00

- ✓ Easy To Remove Adhesive Vinyl
- ✓ Bright Fluorescent Yellow
- ✓ 28 Stock Message Slogans
- ✓ Complete Set Of Numerals + Dollar Sign
- ✓ A Must Have For Any Auto Dealership



LM1 (Plain) RED/ORANGE

LM2 (Printed) RED/ORANGE

Specify style then either number or letter code.

(Example SPS14 = Look)
(Example SPSJ = 9)

Sold By Dozen Per Slogan Only. No Mixed Assortments

SPS 1-28 size 3" x 13"

6-CYLINDER SPS 1	M.P.G. SPS 2	LIKE NEW SPS 3	SALE SPS 4
SPECIAL SPS 5	FULL POWER SPS 6	LOW MILEAGE SPS 7	4-SPEED SPS 8
SAVE SPS 9	GAS-SAVER SPS 10	EXTRA CLEAN SPS 11	AUTOMATIC SPS 12
REDUCE SPS 13	LOOK SPS 14	AIR COND. SPS 15	DISCOUNT SPS 16
AS ADVERTISED SPS 17	ONE OWNER SPS 18	DOWN SPS 19	DEMONSTRATOR SPS 20
DIESEL SPS 21	CASH SPS 22	WE FINANCE SPS 23	PROGRAM CARS SPS 24
AIR BAG SPS 25	WARRANTY SPS 26	CLEARANCE SPS 27	BEST BUY SPS 28

SPS A-K size 4½" x 7½"

\$ SPS A	1 SPS B	2 SPS C	3 SPS D	4 SPS E	5 SPS F	6 SPS G	7 SPS H	8 SPS I	9 SPS J	0 SPS K
--------------------	-------------------	-------------------	-------------------	-------------------	-------------------	-------------------	-------------------	-------------------	-------------------	-------------------

STOCK BANNERS

STOCK BANNERS

STYLE	LENGTH	1-10	11-15	16-24	25+
VB310	3'x10'	\$66.00	\$64.00	\$63.50	\$63.00
VB320	3' x 20'	\$132.70	\$129.30	\$124.76	\$119.09

*HOT ITEM

A



VB310-73



VB310-95



VB310-75



VB310-76



VB310-77



VB310-78



VB310-79



VB310-96



VB310-97



VB310-98



VB310-99



VB310-100



VB310-101



VB310-86



VB310-87



VB310-88



VB310-89



VB310-90



VB310-91



VB310-92



VB310-93



VB310-94

A

3'x10' & 3'x20' MULTI-COLORED VINYL MESSAGE BANNERS

STYLE	SIZE	1-10	11-15	16-24	25+
VB310	3' x 10'	\$ 66.00	\$ 64.00	\$ 63.50	\$ 63.00
VB320	3' x 20'	\$132.70	\$129.30	\$124.76	\$119.09

For Banners With Both Grommets & Ties Add.	\$5.35
For Banners With Wind Slits Add.	\$5.35

- ✓ Reinforced White Vinyl
- ✓ Multi-Colored Digital Imprinting
- ✓ Perimeter Hemmed
- ✓ Two Rows Of Stitching
- ✓ Sewn With Brut-Lon™ Construction
- ✓ Heavy Duty Nylon Cord Sewn In

A

**Larger sizes available.
Please call for quote!**



STOCK MESSAGES



VB310-01



VB310-02



VB310-03



VB310-04



VB310-05



VB310-08



VB310-07



VB310-08



VB310-09



VB310-10



VB310-11



VB310-12



VB310-13



VB310-14



VB310-15



VB310-16



VB310-17



VB310-18

3'x10' & 3'x20' MULTI-COLORED VINYL MESSAGE BANNERS

STYLE	SIZE	1-10	11-15	16-24	25+
VB310	3' x 10'	\$ 66.00	\$ 64.00	\$ 63.50	\$ 63.00
VB320	3' x 20'	\$132.70	\$129.30	\$124.76	\$119.09

For Banners With Both Grommets & Ties Add. \$5.35
 For Banners With Wind Slits Add. \$5.35

- ✓ Reinforced White Vinyl
- ✓ Multi-Colored Digital Imprinting
- ✓ Perimeter Hemmed
- ✓ Two Rows Of Stitching
- ✓ Sewn With Brut-Lon™ Construction
- ✓ Heavy Duty Nylon Cord Sewn In

A



VB310-19

**Larger sizes available.
 Please call for quote!**

STOCK MESSAGES

FOR SALE

VB310-102

OPEN

VB310-20

24 HOURS

VB310-21

Hybrid

VB310-82

**CLOSED FOR
 REMODELING**

VB310-23

**PLEASE EXCUSE OUR MESS
 WHILE WE RENOVATE**

VB310-24

**UNDER
 New
 MANAGEMENT**

VB310-25

**UNDER
 New
 OWNERSHIP**

VB310-26

**HELP
 WANTED**

VB310-27

NOW HIRING

VB310-28

STOP AND SAVE

VB310-29

STOP! LOOK! SAVE!

VB310-30

SE HABLA ESPAÑOL

VB310-31

**WELCOME
 HUNTERS**

VB310-32

GUARANTEED LOW PRICES

VB310-33

SALE

VB310-34

BIG BLOW OUT SALE

VB310-35

**HUGE SUPER
 SALE**

VB310-36

A

3'x10' & 3'x20' MULTI-COLORED VINYL MESSAGE BANNERS

STYLE	SIZE	1-10	11-15	16-24	25+
VB310	3' x 10'	\$ 66.00	\$ 64.00	\$ 63.50	\$ 63.00
VB320	3' x 20'	\$132.70	\$129.30	\$124.76	\$119.09

For Banners With Both Grommets & Ties Add. \$5.35
 For Banners With Wind Slits Add. \$5.35

- ✓ Reinforced White Vinyl
- ✓ Multi-Colored Digital Imprinting
- ✓ Perimeter Hemmed
- ✓ Two Rows Of Stitching
- ✓ Sewn With Brut-Lon™ Construction
- ✓ Heavy Duty Nylon Cord Sewn In

A

**Larger sizes available.
 Please call for quote!**



STOCK MESSAGES



VB310-37



VB310-38



VB310-39



VB310-81



VB310-41



VB310-42



VB310-43



VB310-44



VB310-53



VB310-46



VB310-74



VB310-48



VB310-49



VB310-50



VB310-73



VB310-83



VB310-84



VB310-85

3'x10' & 3'x20' MULTI-COLORED VINYL MESSAGE BANNERS

STYLE	SIZE	1-10	11-15	16-24	25-+
VB310	3' x 10'	\$ 66.00	\$ 64.00	\$ 63.50	\$ 63.00
VB320	3' x 20'	\$132.70	\$129.30	\$124.76	\$119.09

For Banners With Both Grommets & Ties Add. \$5.35
 For Banners With Wind Slits Add. \$5.35

- ✓ Reinforced White Vinyl
- ✓ Multi-Colored Digital Imprinting
- ✓ Perimeter Hemmed
- ✓ Two Rows Of Stitching
- ✓ Sewn With Brut-Lon™ Construction
- ✓ Heavy Duty Nylon Cord Sewn In

A

**Larger sizes available.
 Please call for quote!**



STOCK MESSAGES



VB310-55



VB310-56



VB310-57



VB310-58



VB310-59



VB310-60



VB310-61



VB310-62



VB310-63



VB310-64



VB310-65



VB310-66



VB310-67



VB310-68



VB310-69



VB310-70



VB310-71



VB310-72

A

HOLIDAY FLAGS & BANNERS

3'x5' HORIZONTAL NYLON FLAGS

STYLE	MESSAGE	SIZE	1-10	11-24	25+
XH 1	Noel	3'x5'	\$38.55	\$37.97	\$37.39
XH 2	Merry Christmas	3'x5'	\$38.55	\$37.97	\$37.39
XH 3	Happy Holidays	3'x5'	\$38.55	\$37.97	\$37.39
XH 5	Seasons Greetings	3'x5'	\$38.55	\$37.97	\$37.39
XH 6	Joy to the World	3'x5'	\$38.55	\$37.97	\$37.39
XH 7	Candy Cane	3'x5'	\$38.55	\$37.97	\$37.39
XH 8	Feliz Navidad	3'x5'	\$38.55	\$37.97	\$37.39



XH 1



XH 2



XH 3

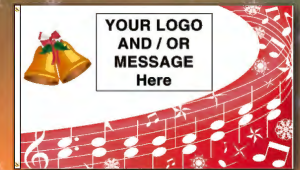

XH Custom

30"x72" VERTICALS

- ✓ 200 Denier All Weather Nylon
- ✓ Sewn With Bracket Sleeves or Grommets
- ✓ Genuine NapLon™ Construction
- ✓ Heavy Canvas Heading
- ✓ Four Rows Of Stitching
- ✓ Poly Bagged

3'x5' HORIZONTALS

- ✓ 200 Denier All Weather Nylon
- ✓ Header & Brass Grommets
- ✓ Genuine NapLon™ Construction
- ✓ Heavy Canvas Heading
- ✓ Four Rows Of Stitching
- ✓ Poly Bagged

30"x72" VERTICAL NYLON POLE FLAGS

STYLE	MESSAGE	SIZE	1-10	11-24	25+
XV 1	Happy Holidays	30"x72"	\$51.40	\$50.83	\$50.24
XV 2	Poinsettia	30"x72"	\$51.40	\$50.83	\$50.24
XV 6	Ribbon Tree	30"x72"	\$51.40	\$50.83	\$50.24
XV 8	Christmas Tree	30"x72"	\$51.40	\$50.83	\$50.24
XV 10	Bell w/gold background	30"x72"	\$51.40	\$50.83	\$50.24
XV 12	Snowman	30"x72"	\$51.40	\$50.83	\$50.24
XV 14	Christmas Tree w/ Ornaments	30"x72"	\$51.40	\$50.83	\$50.24
XV 16	Bell w/red background	30"x72"	\$51.40	\$50.83	\$50.24



XH 5



XH 6



XH 7



XH 8



XV 1



XV 2



XV 8



XV 6



XV 10

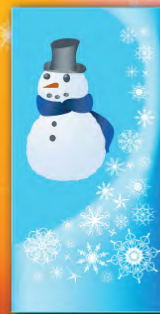

XV 12



XV 14



XV 16



XV 17



XV 18



Custom Sample Layout



HB 1



HB 3



HB 4



HB 2

3'x5' 8 MIL POLY HOLIDAY BANNERS

STYLE	MESSAGE	SIZE	PRICE
HB 1	Merry Christmas	36"x60"	\$21.03
HB 2	Christmas Trees	36"x60"	\$21.03
HB 3	Seasons Greetings	36"x60"	\$21.03
HB 4	Happy Holidays	36"x60"	\$21.03



Pole Banners Pg. 67

HOLIDAY FLAGS & BANNERS

3'x8' VERTICAL POLYESTER FLAGS

STYLE	1-10	11-15	16-24	25+
HF - 1 Sided	\$53.00	\$51.00	\$50.00	\$49.00
HF - 2 Sided	\$95.40	\$91.80	\$90.00	\$88.20
UB - Sleeves*	\$8.00	\$8.00	\$8.00	\$8.00

*Sleeves fit 1" Bracket

3'x8' VERTICALS

- ✓ 3oz All Weather Polyknit
- ✓ Header & Brass Grommets
- ✓ Genuine NapLon™ Construction
- ✓ Heavy Canvas Heading
- ✓ Four Rows Of Stitching
- ✓ Poly Bagged



HF 1



HF 2



HF 3



HF 4



HF 5



HF 6



HF 7



HF 8



HF 9



HF 10



HF 11



HF 12



HF 13



HF 14



HF 15



HF 16

VINYL & METALLIC PRINTED MESSAGE PENNANT STRINGS

PLASTI-CLOTH PRE-PRINTED MESSAGE PENNANTS

STYLE	LENGTH	COLOR	1-10	11-24	25-+
SMP-W	60 FT	White Back	\$40.49	\$39.84	\$39.20
SMP-O	60 FT	Orange Back	\$40.49	\$39.84	\$39.20

Printed in black ink on either orange or white background.

*Not restockable

- ✓ 8oz Plasti-Cloth Vinyl Material
- ✓ BIG 12"x18" Triangle Panels
- ✓ Printed 1 Side
- ✓ Faces Alternate Front & Back

- ✓ May Combine Multi-Messages
- ✓ Sag Resistant Brut-Lon Rope™
- ✓ White Poly Tape
- ✓ Digitally Printed



BLACK PRINT WITH WHITE OR FLUORESCENT ORANGE BACKGROUND



ORDER EXAMPLE:	SMP-W 2
Message:	Sale
Background Color:	White

ORDER EXAMPLE:	SMP-O 8-2
Message:	Grand Opening + Sale
Background Color:	Orange

Custom Printed on page 17



METALLIC FRINGE PENNANTS WITH PRE-PRINTED MESSAGE PANEL

STYLE	LENGTH	COLOR	1-10	11-24	25-+
MPS1	30 FT	Red Print	\$19.86	\$18.69	\$17.53
MPS2	30 FT	Blue Print	\$19.86	\$18.69	\$17.53
MPS3	30 FT	Red Print	\$19.86	\$18.69	\$17.53
MPS4	30 FT	Blue Print	\$19.86	\$18.69	\$17.53
MPS5	30 FT	Red Print	\$19.86	\$18.69	\$17.53

- ✓ Metallic Fringe Panels
- ✓ 12"x18" Printed Poly Panel
- ✓ Printed 1 Side
- ✓ Messages Face Same Direction
- ✓ Sag Resistant Brut-Lon Rope™
- ✓ White Poly Tape
- ✓ Screen Printed

* 25% Restocking Fee



ORDER EXAMPLE:	MPS 1
Message:	Sale
Print Color:	Red



MPS 2



MPS 3



MPS 4



MPS 5

METALLIC FRINGE HOLIDAY PENNANTS WITH PRE-PRINTED MESSAGE PANELS

STYLE	LENGTH	COLOR	1-10	11-24	25-+
CS1	30 FT	Red Print	\$17.53	\$16.95	\$16.36
CS2	30 FT	Green Print	\$17.53	\$16.95	\$16.36
CS3	30 FT	Red Print	\$17.53	\$16.95	\$16.36
CS4	30 FT	Green Print	\$17.53	\$16.95	\$16.36

- ✓ Metallic Fringe Panels
- ✓ 12"x18" Printed Poly Panel
- ✓ Printed 1 Side
- ✓ Messages Face Same Direction
- ✓ Sag Resistant Brut-Lon Rope™
- ✓ White Poly Tape
- ✓ Screen Printed

* 25% Restocking Fee



ORDER EXAMPLE:	CS4
Message:	Happy Holidays
Print Color:	Green



CS 1



CS 2



CS 3



CS 4



WARNING PENNANT STRINGS

12"X18" PRINTED WARNING PENNANTS 60 FOOTERS

STYLE	WARNING	1-10	11-24	25-50	51+
PWPR1	Caution	\$14.00	\$13.75	\$13.50	\$13.25
PWPR2	Keep Out	\$14.00	\$13.75	\$13.50	\$13.25
PWPR3	Danger	\$14.00	\$13.75	\$13.50	\$13.25
PWPR4	Step Back	\$14.00	\$13.75	\$13.50	\$13.25
PWPR5	Keep Away	\$14.00	\$13.75	\$13.50	\$13.25
PWPR6	Open Pit	\$14.00	\$13.75	\$13.50	\$13.25
PWPR7	Construction	\$14.00	\$13.75	\$13.50	\$13.25
PWPR8	Men Working	\$14.00	\$13.75	\$13.50	\$13.25

* 24 Panels Per String

* Yellow Background With Black Imprint

12"X18" PRINTED WARNING PENNANTS 105 FOOTERS

STYLE	WARNING	1-10	11-24	25-50	51+
PWPR1	Caution	\$25.00	\$24.75	\$24.50	\$24.25
PWPR2	Keep Out	\$25.00	\$24.75	\$24.50	\$24.25
PWPR3	Danger	\$25.00	\$24.75	\$24.50	\$24.25
PWPR4	Step Back	\$25.00	\$24.75	\$24.50	\$24.25
PWPR5	Keep Away	\$25.00	\$24.75	\$24.50	\$24.25
PWPR6	Open Pit	\$25.00	\$24.75	\$24.50	\$24.25
PWPR7	Construction	\$25.00	\$24.75	\$24.50	\$24.25
PWPR8	Men Working	\$25.00	\$24.75	\$24.50	\$24.25

* 48 Panels Per String

12"X18" PRINTED WARNING PENNANTS 60 FOOTERS

STYLE	WARNING	1-10	11-24	25-50	51+
PWP1	Caution	\$9.94	\$9.34	\$8.76	\$8.17
PWP2	Keep Out	\$9.94	\$9.34	\$8.76	\$8.17
PWP3	Danger	\$9.94	\$9.34	\$8.76	\$8.17
PWP4	Step Back	\$9.94	\$9.34	\$8.76	\$8.17
PWP5	Keep Away	\$9.94	\$9.34	\$8.76	\$8.17
PWP6	Open Pit	\$9.94	\$9.34	\$8.76	\$8.17
PWP7	Construction	\$9.94	\$9.34	\$8.76	\$8.17
PWP8	Men Working	\$9.94	\$9.34	\$8.76	\$8.17

* 24 Panels Per String

* Yellow Background With Black Imprint

12"X18" PRINTED WARNING PENNANTS 105 FOOTERS

STYLE	WARNING	1-10	11-24	25-50	51+
PWP1	Caution	\$17.88	\$17.41	\$15.77	\$14.72
PWP2	Keep Out	\$17.88	\$17.41	\$15.77	\$14.72
PWP3	Danger	\$17.88	\$17.41	\$15.77	\$14.72
PWP4	Step Back	\$17.88	\$17.41	\$15.77	\$14.72
PWP5	Keep Away	\$17.88	\$17.41	\$15.77	\$14.72
PWP6	Open Pit	\$17.88	\$17.41	\$15.77	\$14.72
PWP7	Construction	\$17.88	\$17.41	\$15.77	\$14.72
PWP8	Men Working	\$17.88	\$17.41	\$15.77	\$14.72

* 48 Panels Per String

* Yellow Background With Black Imprint

- ✓ 4 Mil Polyethylene
- ✓ 60 Foot Long
- ✓ 24 Panels Per String
- ✓ 12"X18" Rectangle Panels
- ✓ 5 Foot Rope Ties (approx.)
- ✓ White Poly Tape
- ✓ Strong Nylon Cord
- ✓ Double Stitched
- ✓ Folded & Bulk Packed



Genuine Brut-Lon™ Construction



- ✓ 4 Mil Polyethylene
- ✓ 105 Foot Long
- ✓ 48 Panels Per String
- ✓ 12"X18" Rectangle Panels
- ✓ 5 Foot Rope Ties (approx.)
- ✓ White Poly Tape
- ✓ Strong Nylon Cord
- ✓ Double Stitched
- ✓ Folded & Bulk Packed



Genuine Brut-Lon™ Construction



- ✓ 4 Mil Polyethylene
- ✓ 60 Foot Long
- ✓ 24 Panels Per String
- ✓ 12"X18" Triangle Panels
- ✓ 5 Foot Rope Ties (approx.)
- ✓ White Poly Tape
- ✓ Strong Nylon Cord
- ✓ Double Stitched
- ✓ Folded & Bulk Packed



Genuine Brut-Lon™ Construction



- ✓ 4 Mil Polyethylene
- ✓ 105 Foot Long
- ✓ 48 Panels Per String
- ✓ 12"X18" Triangle Panels
- ✓ 5 Foot Rope Ties (approx.)
- ✓ White Poly Tape
- ✓ Strong Nylon Cord
- ✓ Double Stitched
- ✓ Folded & Bulk Packed

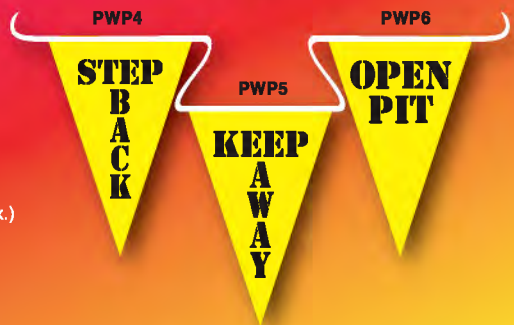

Genuine Brut-Lon™ Construction

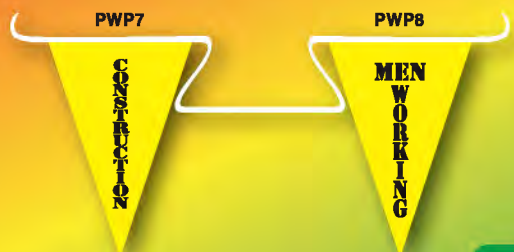

3'x5' AND 3'x10' ECONO BANNERS

STOCK MESSAGE BANNERS (3'x5'EB & 3'x10' SEB)

STYLE	1-10	11-15	16-24	25+
EB 1-15	\$19.50	\$19.00	\$18.50	\$18.00
SEB 1-15	\$34.00	\$33.50	\$33.00	\$32.50

CUSTOM 1 COLOR MESSAGE BANNERS

Minimum order is 25 each. Pick Lettering Style from Listing to the right. All custom message banners are printed in red ink on white 8 mil polyethylene background and sewn with nylon cord throughout top and bottom hem. Text messages only, for banners with custom logos or custom colors see pages 12-13. You may substitute corner grommets, nylon cord for corner grommets

STYLE	25-50	51-100	101-200	201+
CEB 35	\$18.00	\$17.50	\$17.25	\$17.00
CSEB 35	\$30.38	\$29.80	\$29.21	\$28.62

- ✓ 8 Mil Polyethylene
- ✓ Perimeter Hemmed
- ✓ Two Rows Of Stitching
- ✓ Heavy Duty Nylon Cord Sewn In
- ✓ 5FT Of Nylon Cord Per Corner (approx.)
- ✓ Screen Printed
- ✓ Many Stock Messages
- ✓ Optional Custom Messages
- ✓ Brut-Lon™ Construction

CUSTOM MESSAGE FONT CHOICES



EB 13



SEB 20

3'x5' STOCK MESSAGES



3'x10' STOCK MESSAGES



U.S.-TEXAS-MILITARY FLAGS

* Pleated Fans * USA Flags & Kits * Bunting * Pennant Strings * Pull Down Fans * USA Auto Flags

OUTDOOR FLAG

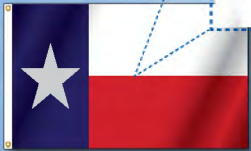

PRINTED NYLON FLAGS

\$136.50

STYLE	SIZE	1-10	11-24	25-100
S&S/TX 23	2' x 3'	\$21.63	\$20.60	\$19.56
S&S/TX 35	3' x 5'	\$35.00	\$33.98	\$32.96
S&S/TX 46	4' x 6'	\$42.23	\$41.19	\$40.17
S&S/TX 58	5' x 8'	\$67.98	\$66.94	\$65.92
S&S/TX 610	6' x 10'	\$98.88	\$95.44	\$92.69

- ✓ 200 Denier Nylon
- ✓ Reinforced Fly Ends
- ✓ 4 Rows Of Stitching
- ✓ Strong Canvas Heading
- ✓ 2 Brass Grommets
- ✓ Screen Printed
- ✓ Poly Bagged
- ✓ Optional Indoor Flag



Indoor USA Flags

2'x3'	Add \$17.39
3'x5'	Add \$26.22
4'x6'	Add \$28.89
5'x8'	Add \$35.58

INDOOR FLAGS INCLUDE

- ✓ Pole Sleeve To Fit Up-To 1-1/4" Pole
- ✓ Gold Fringe On 3 Sides Of Flag
- ✓ Leather Tab (secures flag to pole)

PRINTED POLY-KNIT FLAGS

STYLE	SIZE	1-10	11-24	25-100
S&S/TX -P23	2' x 3'	\$17.89	\$17.00	\$16.00
S&S/TX -P35	3' x 5'	\$28.99	\$28.00	\$27.00
S&S /TX -P46	4' x 6'	\$34.89	\$33.99	\$33.00
S&S /TX -P58	5' x 8'	\$56.00	\$55.29	\$54.39
S&S /TX -P610	6' x 10'	\$81.49	\$78.79	\$76.49

TEXAS APPLIQUE FLAGS

STYLE	SIZE	1-10	11-24	25-100
TX 35-APP	3' x 5'	\$37.25	\$35.49	\$33.92
TX 46-APP	4' x 6'	\$45.04	\$43.13	\$41.27
TX 58-APP	5' x 8'	\$71.31	\$68.67	\$66.04

INDOOR FLAG



Army - Navy - Marine Corps - Air Force - Coast Guard - Police - Fire Dept.

ARMED SERVICES



SUPPORT POLICE



SUPPORT FIRE DEPT.



ARMY



NAVY



MARINE CORPS



AIR FORCE



MILITARY NYLON FLAGS

STYLE	SIZE	1-10	11-24	25-100
MIL23	2' x 3'	\$22.50	\$22.00	\$20.50
MIL35	3' x 5'	\$35.75	\$33.50	\$32.99
MIL46	4' x 6'	\$48.99	\$47.87	\$45.99
MIL58	5' x 8'	\$78.00	\$72.87	\$69.99
MIL610	6' x 10'	\$109.99	\$106.26	\$104.40

MILITARY POLY-KNIT FLAGS

STYLE	SIZE	1-10	11-24	25-100
MIL -P23	2' x 3'	\$20.75	\$19.99	\$18.00
MIL-P35	3' x 5'	\$34.00	\$32.00	\$29.99
MIL -P46	4' x 6'	\$54.00	\$52.69	\$49.99
MIL -P58	5' x 8'	\$58.00	\$56.78	\$54.39
MIL -P610	6' x 10'	\$95.50	\$92.66	\$88.99

COAST GUARD



PATRIOTIC STARS & STRIPES

* Pleated Fans * USA Flags & Kits * Bunting * Pennant Strings * Pull Down Fans * USA Auto Flags

PLEATED FANS

Premium Colors and Standard Colors:

1-4	5-10	11-24	25-100
\$58.75	\$56.24	\$54.72	\$52.99

- ✓ 200 Denier Nylon
- ✓ Canvas Heading
- ✓ 3 Brass Grommets
- ✓ 3 Panel Construction
- ✓ Hand Pleated
- ✓ Standard & Premium Colors
- ✓ 3' x 6'

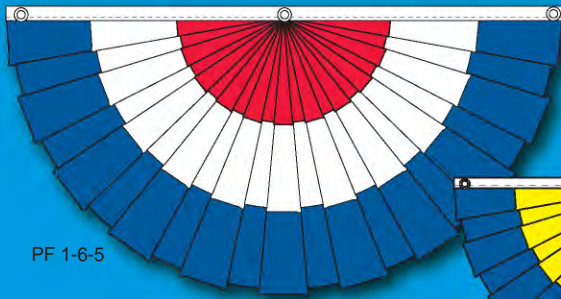

PF 1-6-5



PF 1-6-1

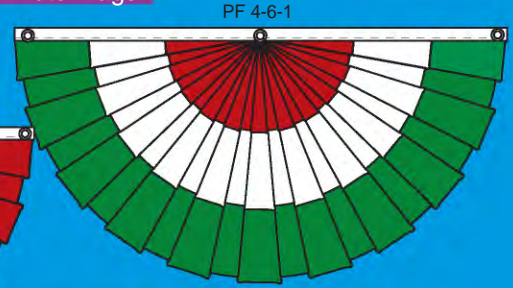

PF 4-6-1



PF 5-3-1

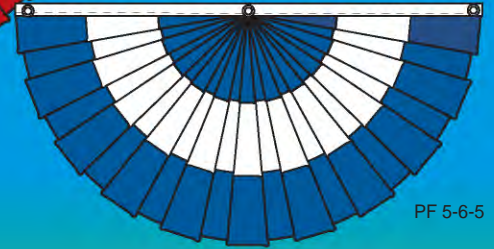

PF 5-6-5

* When ordering panel colors specify TOP / MIDDLE / BOTTOM panel color numbers from above color chart. You may specify standard and premium colors.

STYLE	COLOR PATTERN
PF165	Red / White / Blue
PF531	Red / Yellow / Blue
PF565	Blue / White / Blue
PF161	Red / White / Red
PF461	Red / White / Green
PF464	Red / White / Blue
PF939	Royal / White / Royal
PF262	Orange / White / Orange

Standard Available Colors:	
1 OG Red	6 White
2 Orange	7 Black
3 Spanish Yellow	8 Spice Brown
4 Emerald Green	9 Royal Blue
5 OG Blue	

Premium Available Colors	
10 Magenta	17 Lavender
11 Canadian Red	18 French Blue
12 Salmon	19 Crimson
13 FM Yellow	20 Wineberry
14 Mint Green	21 Pansy
15 Turquoise	22 Buff
16 Gold	23 UN Blue

* Not restockable

OLD GLORY USA PRINTED PENNANT STRINGS

1-20	21-50	51+
\$16.50	\$16.00	\$15.50

STYLE OG-60

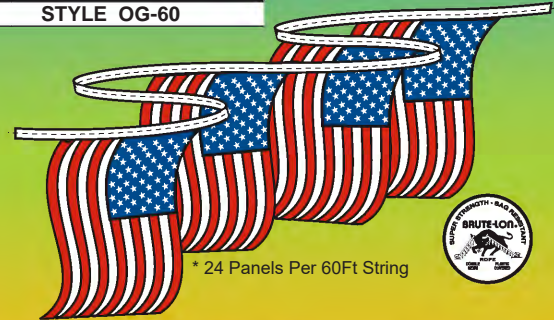

* 24 Panels Per 60ft String



RED WHITE & BLUE FLAT FANS

STYLE	SIZE	1-10	11-15	16-24	25+
FF35	3'x5'	\$31.54	\$30.97	\$30.38	\$29.80
FF46	4'x6'	\$37.97	\$37.39	\$36.81	\$36.22
SSFF35	3'x5'	\$31.54	\$30.97	\$30.38	\$29.80
SSFF46	4'x6'	\$37.97	\$37.39	\$36.81	\$36.22
PD366	3'x6'	\$33.88	\$33.30	\$32.71	\$32.13
PD366	26"x10'	\$42.05	\$41.47	\$40.88	\$40.31

Pole Sleeves	
3'x5'	\$7.38
4'x6'	\$9.84
3'x6'	\$6.96
26"x10'	\$2.46

* Pole sleeve fits 1 inch diameter pole. (Top)

Fans are priced standard with header & grommets across top. Vertical one panel construction. SSFF & PD are printed with star field. Design is visible from both sides.



FF 3'x5'

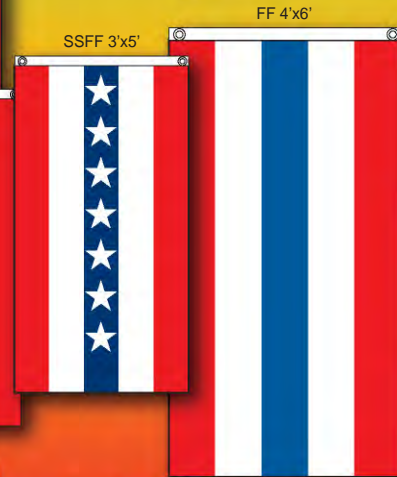

SSFF 3'x5'

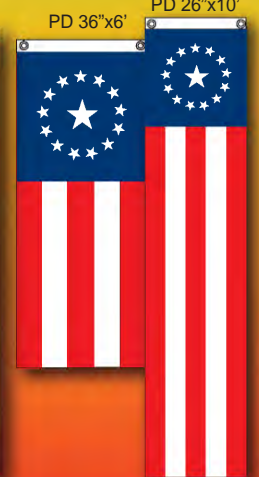

PD 36"x6'

PD 26"x10'

Pole Brackets on page 67

USA & TEXAS AUTOMOTIVE ANTENNA PENNANTS

STYLE	TYPE	1 Dozen	2 Dozen	3 Dozen
TXAC	CLOTH	\$33.88	\$67.75	\$88.79
USAC	CLOTH	\$33.88	\$67.75	\$88.79
USAP	POLY	\$28.03	\$44.39	\$63.09

* Not restockable

- ✓ 4 Mil Clear Polyethylene OR Cloth Material
- ✓ 12"X18" Rectangle Panel
- ✓ Panel Mounted To 32" Poly Sleeve
- ✓ 1 Panel Per Sleeve

Style USAP is Flexographic imprinted 4 mil polyethylene panels and are ideal for short term use only. Not meant for wet conditions. Perfect attention getter for weekend applications.



TXAC



USAC



USAP

ALUMINUM & STEEL FLAGPOLES

12FT 18FT, & 22FT WHITE GIANT STEEL FLAG POLES & 20 FT TELESCOPING ALUMINUM FLAG POLES

PRINTED USA RESIDENTIAL FLAG KITS

1-10	11-24	25-50	51-+
\$31.00	\$27.00	\$26.00	\$25.00

STYLE USHK

Kits Without Flag

STYLE HK

1-10	11-24	25-50	51-+
\$18.00	\$17.75	\$17.00	\$15.80

Includes All Necessary Mounting Hardware! * Not Restockable



- ✓ 3'x5' Printed Polyester *
- ✓ Perimeter Hem
- ✓ Double Stitched
- ✓ Canvas Heading
- ✓ 2 Brass Grommets
- ✓ Plastic Eagle Ornament

REPLACEMENT HARDWARE KITS

RHWG12	\$30.03
RHWG18	\$34.13
RHWG22	\$36.57

*Hardware Kit Includes: Gold Ball, Rope Halyard, Cleat & Screws

TELESCOPING ALUMINUM FLAG POLES

STYLE	1-4	5-10	11-+
TF20	\$290.00	\$280.00	\$278.00

* Not restockable

- ✓ Beautiful Spun Aluminum
- ✓ Built In No-Furl System
- ✓ Built In Theft Protection
- ✓ Easy Bush Button Operation
- ✓ Ornamental Brass Gold Ball
- ✓ Ground Socket

TF20
20' Pole

FOR USA FLAGS
SEE PAGE 46

FOR STATE FLAGS
SEE PAGE 60

22' HIGH

4'x6' Flag
22' Pole
WG22

3'x5' Flag
18' Pole
WG18

3'x5' Flag
12' Pole
WG12

WHITE GIANT STEEL FLAG POLES



STYLE	1-4	5-10	11-25
WG12	\$103.99	\$99.66	\$96.33
WG18	\$123.99	\$116.33	\$111.99
WG22	\$190.00	\$175.00	\$168.00

* Not restockable

- ✓ High Grade Tubular Steel
- ✓ White Enamel Finish
- ✓ 3 Popular Sizes
- ✓ Sectional Steel Assembly
- ✓ Ornamental Gold Ball (vinyl)
- ✓ Ground Socket
- ✓ Cleat
- ✓ Rope Halyard
- ✓ All Hardware Included

EASY 
INSTALL!

STATE AND TERRITORY FLAGS

- ✓ 200 Denier Nylon
- ✓ Reinforced Fly Ends
- ✓ 4 Rows Of Stitching
- ✓ Strong Canvas Heading
- ✓ Two Brass Grommets Mounted To Heading
- ✓ Reads Reverse On Back Side
- ✓ Indoor or Outdoor Flags
- ✓ High Quality Acid-Dye Imprinting

STATE & UN WORLD FLAGS

SIZE	Style	1-5	6-10	11-15	16-24	25 +
2'x3'	A	\$28.43	\$27.36	\$26.29	\$25.29	\$24.32
2'x3'	B	\$30.49	\$29.27	\$28.18	\$27.08	\$26.07
2'x3'	C	\$49.26	\$47.27	\$45.47	\$43.69	\$42.00
3'x5'	A	\$36.98	\$35.54	\$34.14	\$32.82	\$32.67
3'x5'	B	\$39.49	\$37.95	\$36.48	\$35.07	\$33.68
3'x5'	C	\$63.03	\$61.41	\$59.04	\$56.73	\$54.49
4'x6'	A	\$83.47	\$80.17	\$77.01	\$74.00	\$71.05
4'x6'	B	\$89.23	\$85.70	\$82.32	\$79.05	\$75.92
4'x6'	C	\$145.38	\$139.59	\$134.07	\$128.70	\$123.60
5'x8'	A	\$98.99	\$95.06	\$91.31	\$87.69	\$84.23
5'x8'	B	\$105.86	\$101.66	\$97.65	\$93.77	\$90.06
5'x8'	C	\$165.71	\$161.37	\$159.14	\$152.72	\$146.72

****MILITARY FLAGS ON PAGE 43****



AVAILABLE FOR INDOOR DISPLAYS!!

INDOOR FLAGS

3'X5'	N/A	\$56.25	\$51.28	\$47.73	\$44.48	\$41.45
4'X6'	N/A	\$75.60	\$70.37	\$65.51	\$60.98	\$56.79
5'X8'	N/A	\$104.27	\$97.04	\$90.30	\$84.05	\$78.24

Indoor flags include gold yellow fringe on 3 sides, pole sleeve on hoist side to fit up to a 1 1/4" diameter pole. Leather tap. Nylon Backing if flag not double sided. For double sided indoor flag please double price. Includes opaque liner.



UN MEMBER FLAGS FEATURED ON NEXT 4 PAGES. USE PRICING ABOVE FOR ALL STATE & UN FLAGS. USE FLAG STYLE CODE TO FIND PRICE.



A-ALABAMA



A-HAWAII



B-MASSACHUSETTS



A-NEW MEXICO



A-SOUTH DAKOTA



A-ALASKA



C-IDAHO



C-MICHIGAN



C-NEW YORK



B-TENNESSEE



B-ARIZONA



C-ILLINOIS



C-MINNESOTA



A-NORTH CAROLINA



SEE PAGE 43



A-ARKANSAS



A-INDIANA



A-MISSISSIPPI



C-NORTH DAKOTA



C-UTAH



B-CALIFORNIA



B-IOWA



C-MISSOURI



A-OHIO



C-VERMONT



A-COLORADO



C-KANSAS



C-MONTANA



C-OKLAHOMA



C-VIRGINIA



C-CONNECTICUT



C-KENTUCKY



B-NEBRASKA



C-OREGON



C-WASHINGTON



C-DELAWARE



B-LOUISIANA



A-NEVADA



B-PENNSYLVANIA



C-WEST VIRGINIA



C-FLORIDA



C-MAINE



B-NEW HAMPSHIRE



A-RHODE ISLAND



C-WISCONSIN



A-GEORGIA



A-MARYLAND



C-NEW JERSEY



A-SOUTH CAROLINA



A-WYOMING



A-DISTRICT OF COLUMBIA



C-GUAM



A-PUERTO RICO



B-VIRGIN ISLANDS

FLAGS OF THE UNITED NATIONS



B-AFGHANISTAN



A- ALBANIA



B-ALGERIA



C-ANDORRA



B-ANGOLA



A-ANTIGUA AND BARBUDA



A-ARGENTINA



B-ARMENIA



B-AUSTRALIA



A-AUSTRIA



B-AZERBAIJAN



C-BAHAMAS



B-BAHRAIN



B-BANGLADESH



B-BARBADOS



B-BELARUS



A-BELGIUM



C-BELIZE



A-BENIN



B-BHUTAN



C-BOLIVIA



A-BOTSWANA



B-BRAZIL



B-BRUNEI



A-BULGARIA



B-BURKINA FASO



B-BURMA (MYANMAR)



B-BURUNDI



B-CAMBODIA



A-CAMEROON



A-CANADA



B-CAPE VERDE



B-CENTRAL AFRICAN REPUBLIC



A-CHAD



A-CHILE



B-CHINA, PEOPLES REPUBLIC OF



A-COLOMBIA



B-COMOROS



B-CONGO, REPUBLIC OF



B-CONGO, DEMOCRATIC REPUBLIC OF



B-COSTA RICA

FLAGS OF THE UNITED NATIONS



C-CROATIA



B-CUBA



B-CYPRUS



B-CZECH REPUBLIC



A-DENMARK



B-DJIBOUTI



C-DOMINICA



C- DOMINICAN REPUBLIC



C-ECUADOR



B-EGYPT



B-EL SALVADOR



B-EQUATORIAL GUINEA



B-ERITREA



A-ESTONIA



B-ETHIOPIA



C-FIJI



A-FINLAND



A-FRANCE



A-GABON



A-GAMBIA



B-GEORGIA



A-GERMANY



B-GHANA



B-GREECE



B-GRENADA



C-GUATEMALA



A-GUINEA



A-GUINEA-BISSAU



B-GUYANA



B-HAITI



B-HONDURAS



A-HUNGARY



B-ICELAND



A-INDIA



A-INDONESIA



B-IRAN



B-IRAQ



A-IRELAND



A-ISRAEL



A-ITALY



A-COTE D'IVOIRE (IVORY COAST)



B-JAMAICA



B-JAPAN



B-JORDAN



B-KAZAKZSTAN



B-LAOS



A-LATVIA



B-LEBANON

FLAGS OF THE UNITED NATIONS



B-LESOTHO



B- LIBERIA



A-LYBIA



B-LIECHTENSTEIN



A-LITHUANIA



A-LUXEMBOURG



B-MACEDONIA



A-MADAGASCAR



B-MALAWI



B-MALAYSIA



B-MALDIVES



A-MALI



B-MALTA



B-MARSHALL ISLAND



B-MAURITANIA



A-MAURITIUS



B-MEXICO



B-MICRONESIA



B-MOLDAVIA

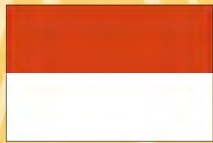

A-MONACO



B-MONGOLIA



B-MOROCCO



B-MOZAMBIQUE



C-NAMIBIA



B-NAURU



B-NEPAL



A-NETHERLANDS



B-NEW ZEALAND



C-NICARAGUA



A-NIGER



B-NIGERIA



B-NORTH KOREA



B-NORWAY



B-OMAN



B-PAKISTAN



B-PALAU



B-PANAMA



B-PAPAU NEW GUINEA



C-PARAGUAY



C-PERU



B-PHILLIPPINES



A-POLAND



B-PORTUGAL



B-QATAR



A-ROMANIA



A-RUSSIAN REPUBLIC



B-RWANDA



B-SOMOA

FLAGS OF THE UNITED NATIONS



B-SAN MARINO



B-SAO TOME AND PRINCPE



B-SAUDI ARABIA



A-SENEGAL



B-SEYCHELLES



A-SIERRA LEONE



B-SINGAPORE



B-SLOVAKIA

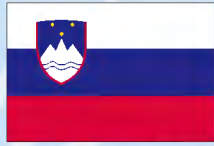

B-SLOVENIA



B-SOLOMON ISLANDS



A-SOMALIA



B-SOUTH AFRICA



B-SOUTH KOREA



B-SPAIN



B-SRI LANKA



B-ST. KITTS-NEVIS



B-ST. LUCIA



B-ST. VINCENT AND GRENADINES



B-SUDAN



B-SURINAM



C-SWAZILAND



A-SWEDEN



A-SWITZERLAND

- ✓ 200 Denier Nylon
- ✓ Reinforced Fly Ends
- ✓ 4 Rows of Stitching
- ✓ Strong Canvas Heading
- ✓ Two Brass Grommets Mounted to Heading
- ✓ Reads Reverse on Back Side
- ✓ Indoor or Outdoor Flags
- ✓ High Quality Acid-Dye Printing



A-SYRIA



B-TAJIKISTAN



B-TANZANIA



A-THAILAND



B-TOGO



B-TONGA



B-TRINIDAD AND TOBAGO



B-TUNISIA



B-TURKEY



C-TURKMENISTAN



B-TUVALU



B-UGANDA



A-UKRAINE



A-UNITED ARAB EMIRATES



A-UNITED KINGDOM



B-URUGUAY



B-UZBEKISTAN



B-VANUATU



B-VENEZUELA



B-VIETNAM



A-YEMEN



A-YUGOSLAVIA



B-ZAMBIA



B-ZIMBABWE

"SAIL" FLAGS

SAIL FLAGS

NYLON SAIL FLAGS

* Standard Colors

STYLE	SIZE	1-10	11-15	16-24	25+
SF38	3'x8'	\$29.38	\$28.81	\$27.11	\$25.97
SF410	4'x10'	\$36.18	\$35.05	\$34.48	\$32.78
SF510	5'x10'	\$46.39	\$44.12	\$41.85	\$40.72

* Not restockable

AVAILABLE COLORS:

1 OG Red	4 Emerald Green	7 Black
2 Orange	5 OG Blue	8 Spice Brown
3 Spanish Yellow	6 White	9 Royal Blue

* Specify style size and color number(s) when ordering

NYLON SAIL FLAGS

* Premium Colors

STYLE	SIZE	1-10	11-15	16-24	25-50
SF38	3'x8'	\$38.33	\$35.33	\$32.33	\$31.33
SF410	4'x10'	\$45.99	\$42.99	\$41.99	\$38.99
SF510	5'x10'	\$58.99	\$55.99	\$51.99	\$48.99

* Not restockable

AVAILABLE COLORS

10 Magenta	14 Mint Green	18 French Blue	22 Buff
11 Canadian Red	15 Turquoise	19 Crimson	23 UN Blue
12 Salmon	16 Gold	20 Wineberry	24 Brick Red
13 FM Yellow	17 Lavender	21 Pansy	25 Dartmouth Green

* Specify style size and color number(s) when ordering

Sail flags are priced standard with 1 panel construction sewn with header & brass grommets. For multi-panel configurations see price chart at top right.

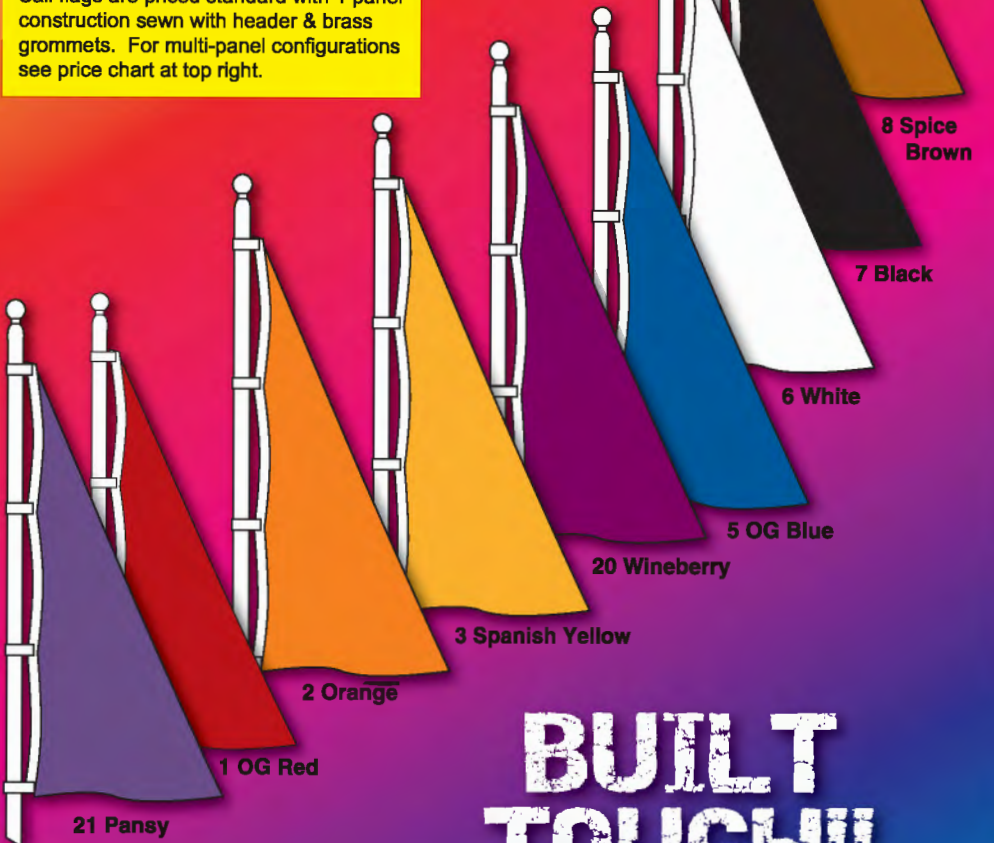

A

BUILT TOUGH!!

PANEL CONFIGURATIONS

2 Horizontal Stripes	Add 25%	(Net)
3 Horizontal Stripes	Add 25%	(Net)
2 Vertical Stripes	Add 25%	(Net)
3 Vertical Stripes	Add 25%	(Net)
2 Diagonal Stripes	Add 30%	(Net)
3 Diagonal Stripes	Add 30%	(Net)

Made With Genuine Nap-Lon Construction



SOLID & STRIPED ATTENTION FLAGS

2'x3'

3'x5'

4'x6'

5'x8'

6'x10'

STANDARD COLORED ATTENTION FLAGS

STYLE	SIZE	1-4	5-8	9-15	16-24	25-+
NF23	2'x3'	\$18.04	\$17.56	\$17.19	\$16.82	\$16.44
NF35	3'x5'	\$26.03	\$25.71	\$25.40	\$24.79	\$24.18
GNF46	4'x6'	\$41.97	\$41.65	\$41.04	\$40.44	\$38.89
GNF58	5'x8'	\$49.33	\$49.01	\$48.39	\$47.80	\$46.25
GNF610	6'x10'	\$110.66	\$110.34	\$109.74	\$109.13	\$107.58

* Not restockable

PREMIUM COLORED ATTENTION FLAGS

STYLE	SIZE	1-4	5-8	9-15	16-24	25-+
NF23	2'x3'	\$22.28	\$21.67	\$21.18	\$20.69	\$20.19
NF35	3'x5'	\$32.64	\$32.15	\$31.85	\$31.05	\$30.25
GNF46	4'x6'	\$51.92	\$51.54	\$50.77	\$50.00	\$48.11
GNF58	5'x8'	\$61.12	\$60.73	\$59.99	\$59.22	\$57.30
GNF610	6'x10'	\$137.79	\$137.41	\$136.64	\$135.87	\$133.97

* Not restockable

Nylon attention flags are priced standard with header and brass grommets. Single panel construction with double stitched perimeter for durability. For multi-panel designs or pole sleeves additions see prices below. Choose panel colors from either standard or premium color listing. If combining standard and premium colors together please use premium color price list.

MULTI-PANEL CONFIGURATIONS

SIZE	DIAGONAL 2 PANEL	VERTICAL 2 PANEL	HORIZONTAL 2 PANEL
2'x3'	Add 25%	NO CHARGE	NO CHARGE
3'x5'	Add 25%	NO CHARGE	NO CHARGE
4'x6'	Add 25%	NO CHARGE	NO CHARGE
5'x8'	Add 25%	NO CHARGE	NO CHARGE
6'x10'	Add 25%	NO CHARGE	NO CHARGE
SIZE	DIAGONAL 3 PANEL	VERTICAL 3 PANEL	HORIZONTAL 3 PANEL
2'x3'	Add 30%	NO CHARGE	NO CHARGE
3'x5'	Add 30%	NO CHARGE	NO CHARGE
4'x6'	Add 30%	NO CHARGE	NO CHARGE
5'x8'	Add 30%	NO CHARGE	NO CHARGE
6'x10'	Add 30%	NO CHARGE	NO CHARGE

POLE SLEEVES

2'x3'	\$4.92
3'x5'	\$7.38
4'x6'	\$9.84
5'x8'	\$12.31
6'x10'	\$14.77

FOR 1" DIAMETER POLE

STANDARD COLORS AVAILABLE



01 OG Red



04 Emerald Green



07 Black

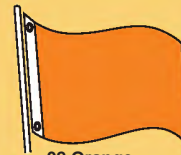

02 Orange



05 OG Blue



08 Spice Brown



03 Spanish Yellow

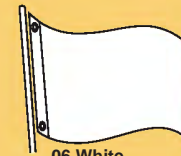

06 White



09 Royal Blue



TALL ATTENTION FLAGS

Order Example

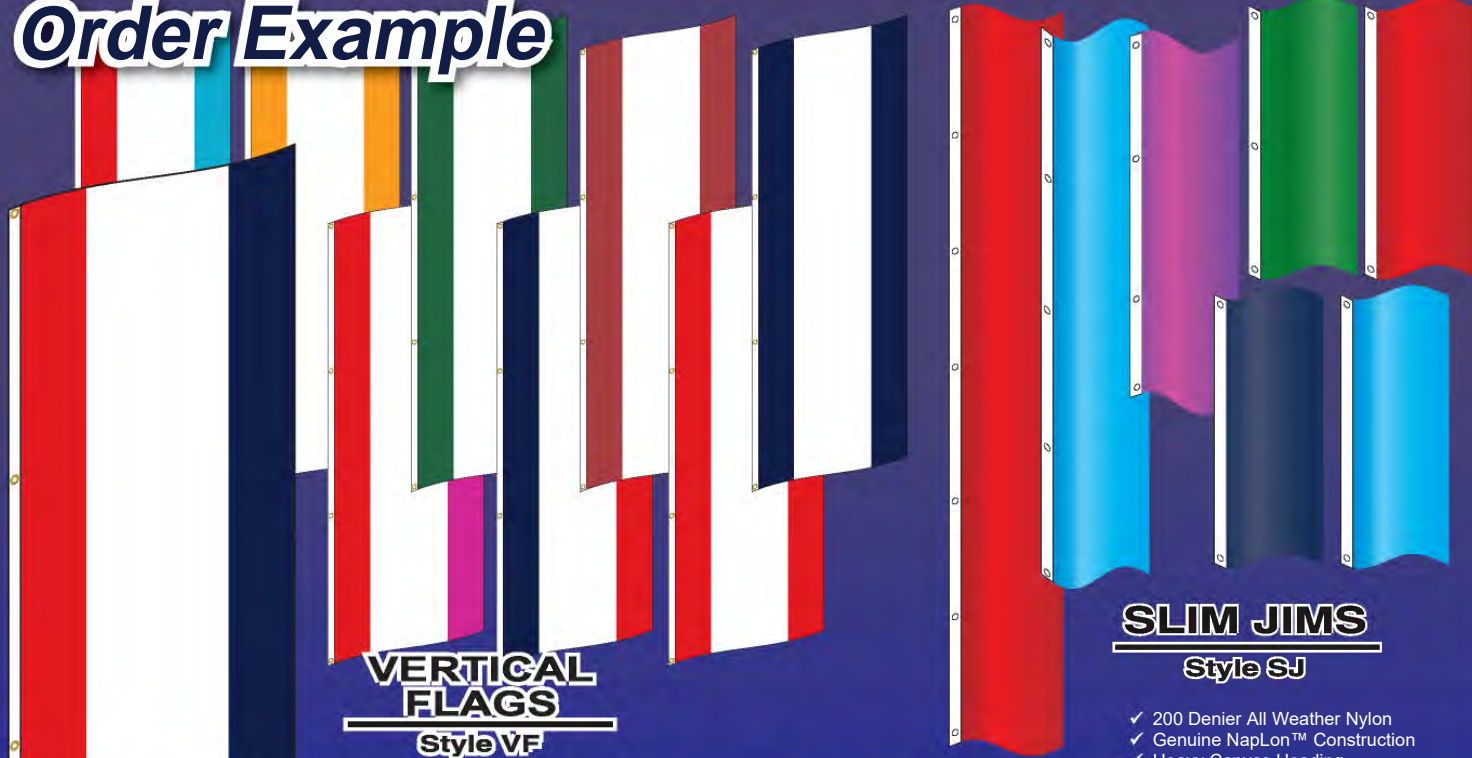

VERTICAL FLAGS Style VF

SLIM JIMS

Style SJ

- ✓ 200 Denier All Weather Nylon
- ✓ Genuine NapLon™ Construction
- ✓ Heavy Canvas Heading
- ✓ Brass Grommets
- ✓ Plastic Zip Ties For Quick Installation
- ✓ Reinforced Fly Ends
- ✓ Four Rows Of Stitching
- ✓ Poly Bagged

Diagonal 2 Panel

Diagonal 3 Panel

Vertical 2 Panel

Vertical 3 Panel

Horizontal 2 Panel

Horizontal 3 Panel

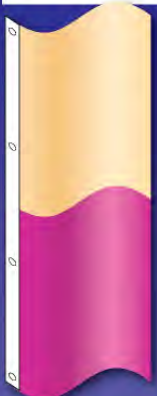
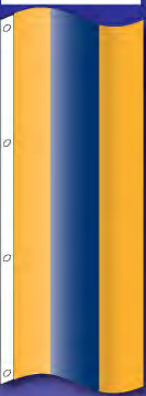
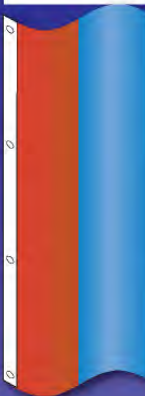
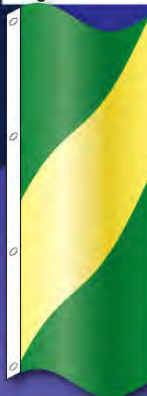
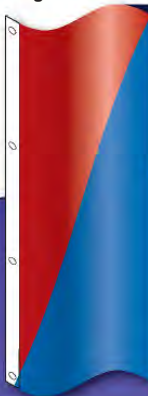

GROMMETS & STRAPS COME STANDARD!

STYLE	QUALITY	STYLE	QUALITY
SJ06	3 EACH	VF08	4 EACH
SJ08	4 EACH	VF10	4 EACH
SJ12	5 EACH	VF12	5 EACH
SJ16	7 EACH	VF16	7 EACH

POLE SLEEVES

2 Sleeves	\$8.00
-----------	--------

- * Sleeves will fit 1" pole bracket.
- * Sleeves on 2½' or 3' Side only.

STANDARD COLORED AND PREMIUM COLORED SLIM JIMS/ VERTICAL ATTENTION FLAGS

* Not restockable

A

STYLE	SIZE	1-10	11-15	16-24	25-50
SJ06	2½'x6'	\$28.63	\$27.27	\$25.93	\$25.13
SJ08	2½'x8'	\$37.99	\$36.20	\$34.41	\$33.31
SJ12	2½'x12'	\$57.25	\$53.99	\$51.24	\$49.68
SJ16	2½'x16'	\$75.44	\$71.83	\$68.12	\$66.08
VF08	3'x8'	\$45.46	\$43.34	\$41.20	\$39.06
VF10	3'x10'	\$56.70	\$53.99	\$51.35	\$49.76
VF12	3'x12'	\$67.95	\$64.69	\$61.41	\$59.59
VF16	3'x16'	\$90.40	\$86.09	\$82.91	\$80.77

Flag is priced standard with header & grommets. Vertical design with solid panel construction. For diagonal and multicolored configurations please see below multi-panel options.

SIZE	DIAGONAL 2 PANEL	VERTICAL 2 PANEL	HORIZONTAL 2 PANEL
2'x3'	Add 25%	NO CHARGE	NO CHARGE
3'x5'	Add 25%	NO CHARGE	NO CHARGE
4'x6'	Add 25%	NO CHARGE	NO CHARGE
5'x8'	Add 25%	NO CHARGE	NO CHARGE
SIZE	DIAGONAL 3 PANEL	VERTICAL 3 PANEL	HORIZONTAL 3 PANEL
2'x3'	Add 30%	NO CHARGE	NO CHARGE
3'x5'	Add 30%	NO CHARGE	NO CHARGE
4'x6'	Add 30%	NO CHARGE	NO CHARGE
5'x8'	Add 30%	NO CHARGE	NO CHARGE
6'x10'	Add 30%	NO CHARGE	NO CHARGE

PREMIUM COLORS AVAILABLE



Pole Brackets on page

67

CNC ROUTERS - CUT & PRINT



**UP TO
1 1/4" THICK**

We have the capability to cut from boards or sheets up to 5'x10'

Materials Used: Almost any material can be used in a CNC machine. It really depends on the application. Common materials include metals and wood such as

- | | | | |
|-----------|----------------|----------------|-------------|
| MDO board | Calender vinyl | Plexiglass | Ultra board |
| MDF board | Mega-bond | Lexan | Alumalite |
| PVC board | Foamcore | Particle board | Hardwood |
| Plywood | Coroplast | Chipboard | |
| Styrene | Aluminum | Veneer | |



AUTOMOTIVE ANTENNA PENNANTS

MYLAR METALLIC

FLUORESCENT VINYL

POLYETHYLENE PLASTIC

8oz PLASTIC-CLOTH VINYL TRIANGLE PENNANTS

STYLE	1 dozen	2 dozen	3 dozen	4 dozen
FAP	\$23.96	\$42.05	\$55.01	\$70.10
RAP	\$23.96	\$42.05	\$55.01	\$70.10

Standard Colors

10 Red
20 Orange
30 Yellow
40 Green
5 Blue
6 White
7 Black

- ✓ 8oz Plastic-Cloth Vinyl
- ✓ Five Triangle Panels Per Sleeve
- ✓ 32" Poly Plastic Sleeve Double Sewn
- ✓ Rolled & Shrink Wrapped
- ✓ Packaged One Dozen Per Color
- ✓ Made To Order
- ✓ Standard & Fluorescent Colors
- ✓ Choose Your Own Color Combo

FAP1	Rocket Red
FAP2	Blaze Orange
FAP3	Saturn Yellow
FAP4	Signal Green
FAP20	Standard Orange
FAP100	Multi-Flourescent

Fluorescent Colors

1 Rocket Red
2 Blaze Orange
3 Saturn Yellow
4 Signal Green
8 Flame Pink

* Not restockable

RAP117	Rainbow Colors
--------	----------------

METALLIC TRIANGLE PENNANTS

STYLE	1 dozen	2 dozen	3 dozen	4 dozen
MAP	\$23.96	\$42.05	\$55.01	\$70.10

Colors

1 Red	2 Orange	3 Gold	4 Green	5 Blue
6 Silver	7 Turquoise	8 Purple	9 Wineberry	10 Magenta

Metallic Triangle Pennants on page 61

- ✓ Metallic
- ✓ Five Triangle Panels Per Sleeve
- ✓ 32" Poly Plastic Sleeve Double Sewn
- ✓ Rolled & Shrink Wrapped
- ✓ Packaged One Dozen Per Color
- ✓ Made To Order
- ✓ Choose Your Own Color Combo

* Not restockable

MAP-1-6-5	Red / Silver / Blue
MAP-5-6	Blue / Silver
MAP-9	Wineberry
MAP-1	Red
MAP-6	Silver
MAP-5	Blue



FAP 100



MAP 1-6-5

METALLIC FRINGE PENNANTS

STYLE	1 dozen	2 dozen	3 dozen	4 dozen
MAF	\$28.03	\$49.07	\$70.10	\$88.79
RAF	\$28.03	\$49.07	\$70.10	\$88.79

Colors * Not restockable

1 Red	2 Orange	3 Gold	4 Green	5 Blue
6 Silver	7 Turquoise	8 Purple	9 Wineberry	10 Magenta

Metallic Fringe Pennants on page 64

- ✓ Metallic
- ✓ Five Fringe Panels Per Sleeve
- ✓ 32" Poly Plastic Sleeve Double Sewn
- ✓ Rolled & Shrink Wrapped
- ✓ Packaged One Dozen Per Color
- ✓ Made To Order
- ✓ Choose Your Own Color Combo

MAF-1-6-5	Red / Silver / Blue
MAF-5-6	Blue / Silver
MAF-9	Wineberry
MAF-1	Red
MAF-6	Silver
MAF100	Multi
RAF99	Rainbow Colors

POLY CHECKERED TRIANGLE PENNANTS

STYLE	1 dozen	2 dozen	3 dozen	4 dozen
CAP1	\$19.28	\$32.71	\$42.05	\$52.15
CAP2	\$19.28	\$32.71	\$42.05	\$52.15

Style CAP is Flexographic imprinted 4 mil polyethylene panels and are ideal for short term use only. Not meant for wet conditions. Perfect attention getter for weekend applications.

- ✓ Five 4 Mil Clear Polyethylene Panels
- ✓ Flexographic Imprinting On One Side
- ✓ 32" Poly Plastic Sleeve Double Sewn
- ✓ Rolled & Shrink Wrapped
- ✓ Packaged One Dozen Per Color
- ✓ Made To Order (not a stock item)
- ✓ Choose From Red or Black Checks

* Not restockable

Style CAP1 is Red & White Checks
Style CAP2 is Black & White Checks



MAF 100



CAP 1

BUNTING MATERIALS

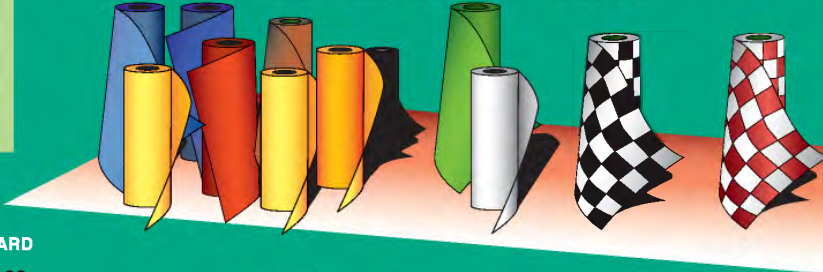

200 Denier Nylon Bunting (60" widths)

STYLE	COLOR	PER YARD
N1	Old Glory Red	\$13.93
N2	Orange	\$13.93
N3	Spanish Yellow	\$13.93
N4	Emerald Green	\$13.93
N5	Old Glory Blue	\$13.93
N6	White	\$13.93
N7	Black	\$13.93
N8	Brown	\$13.93
N9	Royal Blue	\$13.93
N16	Gold	\$13.93

- ✓ 200 All Weather Nylon
- ✓ 10 Brilliant Colors
- ✓ Large 60 Inch Wide
- ✓ Sold Per Yard
- ✓ Premium Colors Also Available

Polyethylene 4 Mil Bunting (18" widths)

STYLE	COLOR	PER YARD
P1	Red	\$1.83
P2	Orange	\$1.83
P3	Yellow	\$1.83
P4	Green	\$1.83
P5	Blue	\$1.83
P6	White	\$1.83
P7	Black	\$1.83

- ✓ 4 Mil Virgin Polyethylene
- ✓ 7 Standard Colors
- ✓ 18" Inch Wide
- ✓ Sold Per Yard

Metallic Bunting (18" widths)

STYLE	COLOR	PER YARD
M1	Red	\$4.86
M2	Orange/Bronze	\$4.86
M3	Gold	\$4.86
M4	Green	\$4.86
M5	Blue	\$4.86
M6	Silver	\$4.86

- ✓ Metallic Film
- ✓ 6 Brilliant Colors
- ✓ 18" Inch Wide
- ✓ Reflects Light
- ✓ Sold Per Yard

Race Track Polyethylene 2 Mil Bunting (18" widths)

STYLE	COLOR	PER YARD
PB1	Red & White	\$2.06
PB7	Black & White	\$2.06

- ✓ 4 Mil Virgin Polyethylene
- ✓ 2 Check Colors
- ✓ 18" Inch Wide
- ✓ Sold Per Yard

Material is Flexographic imprinted and should be used indoors only Use outdoors for short periods of time. Should not be used in wet conditions.

HURRICANE PENNANT STRINGS

HURRICANE PLASTIC-CLOTH PENNANTS

STYLE	LENGTH	1-10	11-30	31-50	51-100	101-250
HR	60 FT	\$27.50	\$26.95	\$26.40	\$25.85	\$25.03
HR	110 FT	\$48.13	\$47.30	\$46.20	\$45.65	\$45.10

* Not Restockable



- ✓ 8 oz Plastic-Coated Vinyl
- ✓ 6"x18" Triangle Panels
- ✓ Fluorescent & Standard Colors Available
- ✓ You Build Color Combination!
- ✓ 5 Bright Fluorescent Colors
- ✓ 7 Standard Colors
- ✓ Sag Resistant Brut-Lon™ Rope

Genuine Brut-Lon™ Construction

HR 60 FT 40 Panels
HR 110 FT 80 Panels

6"x18"

ORDER EXAMPLE: HR 5-3-5 110
Color Pattern: Standard Blue – Saturn Yellow – Standard Blue
Length: 110 Feet

ORDER EXAMPLE: HR 3-8 60
Color Pattern: Saturn Yellow – Flame Pink
Length: 60 Feet



Use Color Number(s) To Build String

Standard Colors Fluorescent Colors

- | | |
|-----------|-----------------|
| 10 Red | 1 Rocket Red |
| 20 Orange | 2 Blaze Orange |
| 30 Yellow | 3 Saturn Yellow |
| 40 Green | 4 Signal Green |
| 5 Blue | 8 Flame Pink |
| 6 White | |
| 7 Black | |

Build Your Own Custom Color Combination!!



HR 100 Assorted Colors

CYCLONE & STRIPERS PENNANT STRINGS

CYCLONE & STRIPERS PLASTIC-CLOTH PENNANTS

STYLE	LENGTH	1-10	11-30	31-50	51-100	101++
CY	60 FT	\$27.50	\$26.95	\$26.40	\$25.30	\$24.20
CY	110 FT	\$44.55	\$44.28	\$44.00	\$43.45	\$41.80
ST	60 FT	\$26.40	\$25.85	\$25.30	\$24.75	\$24.20

* Not restockable.

- ✓ 8 oz Plastic-Coated Vinyl
- ✓ 4"x18" Triangle Panels (Cyclone)
- ✓ 2"x18" Rectangle Panels (Stripers)
- ✓ Fluorescent & Standard Colors Available
- ✓ You Build Color Combination!
- ✓ 5 Bright Fluorescent Colors
- ✓ 7 Standard Colors
- ✓ Sag Resistant Brut-Lon™ Rope

Genuine Brut-Lon™ Construction

CY 60 FT 52 Panels
 CY 100 FT 00 Panels
 ST 60 FT 45 Panels

ORDER EXAMPLE: CY 5-3-5 60
 Color Pattern: Standard Blue – Saturn Yellow – Standard Blue
 Length: 60 Feet

ORDER EXAMPLE: ST 3-8 60
 Color Pattern: Saturn Yellow – Flame Pink
 Length: 60 Feet

4"x18"
&
2"x18"



Standard Colors Fluorescent Colors

10 Red	1 Rocket Red
20 Orange	2 Blaze Orange
30 Yellow	3 Saturn Yellow
40 Green	4 Signal Green
5 Blue	8 Flame Pink
6 White	
7 Black	

Build Your Own Custom Color Combination!!



CY 1-3-4 Red-Yellow-Green

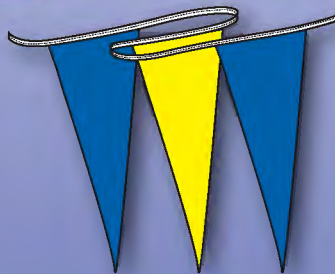

CY 5-3-5 Blue-Yellow-Blue

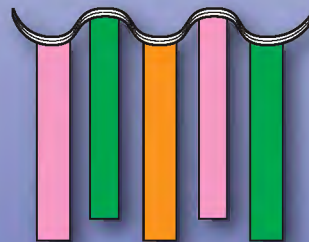

ST 8-4-2 Pink-Green-Orange

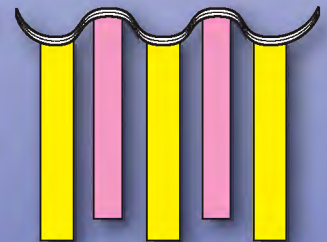

ST 3-8 Yellow-Pink

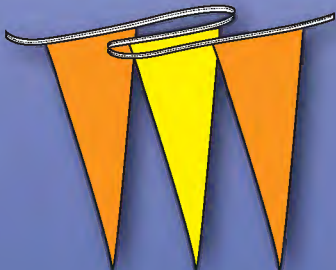

CY 2-3-2 Orange-Yellow-Orange

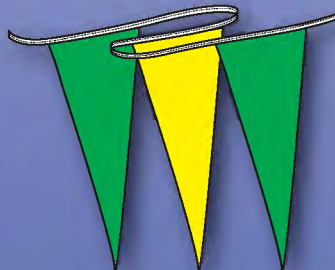

CY 4-3-5 Green-Yellow-Green

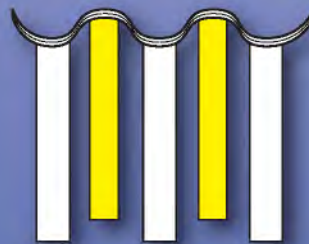

ST 6-3-6 White-Yellow-White

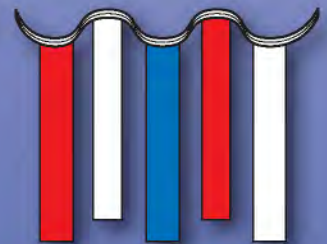

ST 1-5-6 Red-White-Blue

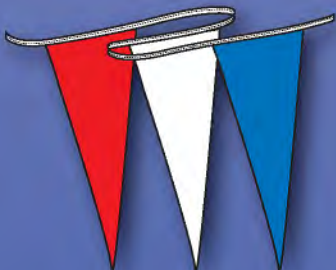

CY 1-6-5 Red-White-Blue

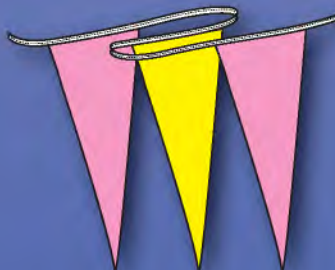

CY 8-3-8 Pink-Yellow-Pink

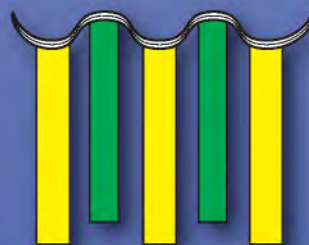

ST 3-4-3 Yellow-Green-Yellow

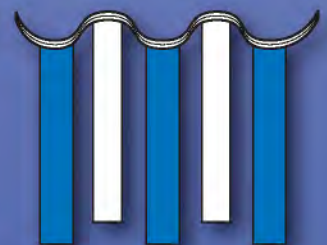

ST 5-6 Blue-White



CY STYLE

CY 100 Assorted Colors

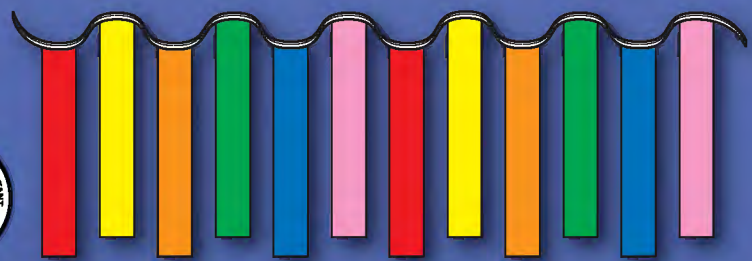

ST STYLE

ST 100 Assorted Colors

STYLE SETTERS & THE HAWKS POLY PENNANTS

4 MIL POLYETHYLENE PENNANTS

STYLE	LENGTH	1-10	11-25	26-100	101-250
TH	60 FT	\$11.50	\$ 11.25	\$ 11.00	\$10.50
TH	120 FT	\$18.00	\$17.50	\$17.00	\$16.50
SS	110 FT	\$16.25	\$16.00	\$15.25	\$14.50

* Not restockable.

- ✓ 4 Mil Polyethylene Plastic
- ✓ 9"x12" Triangle Panels (The Hawks)
- ✓ 6"x18" Triangle Panels (Style Setter)
- ✓ 7 Colors To Mix & Match
- ✓ You Build Color Combination!
- ✓ Sag Resistant Brut-Lon™ Rope
- ✓ 3 Popular Lengths

Genuine Brut-Lon™ Construction

TH 60 50 Panels
TH 120 100 Panels
SS 100 80 Panels

ORDER EXAMPLE: TH 5-6-5 120
Color Pattern: Blue-White-Blue
Length: 120 Feet

ORDER EXAMPLE: SS 1-6-5 110
Color Pattern: Red-White-Blue
Length: 110 Feet

6" x 18"
&
9" x 12"

**Build Your Own
 Custom Color
 Combination!!**

Use Color Number(s) To Build String

Available Poly Colors	
1 Red	5 Blue
2 Orange	6 White
3 Yellow	7 Black
4 Green	

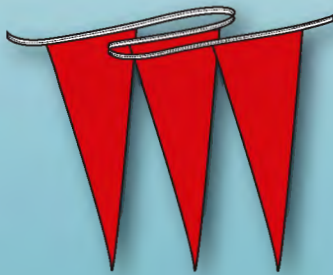

SS 1 Red

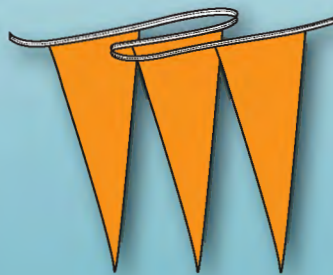

SS 2 Orange

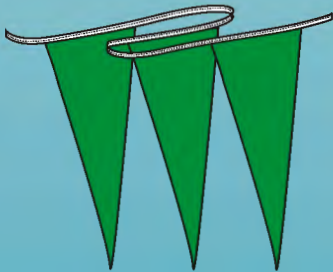

SS 4 Green

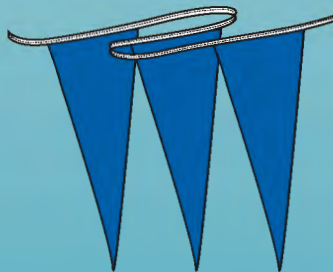

SS 5 Blue



SS 1-6-5 Red-White-Blue

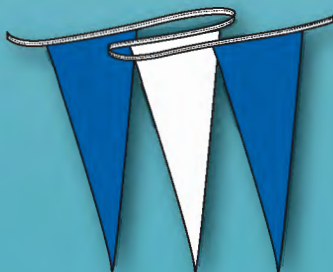

SS 5-6-5 Blue-White-Blue

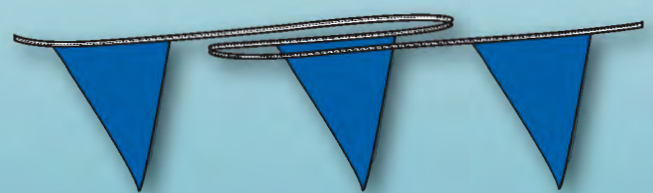

TH 5 Blue

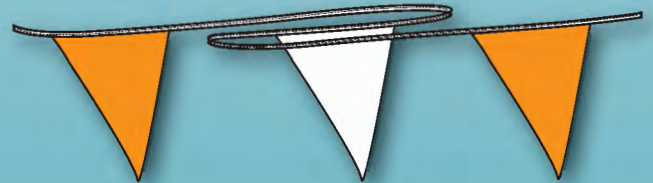

TH 2-6-2 Orange-White-Orange

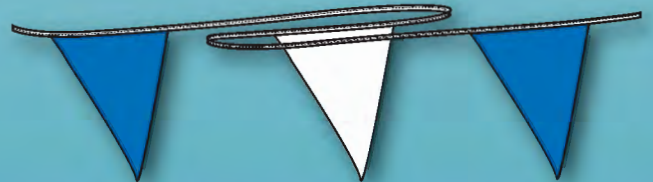

TH 5-6-5 Blue-White-Blue

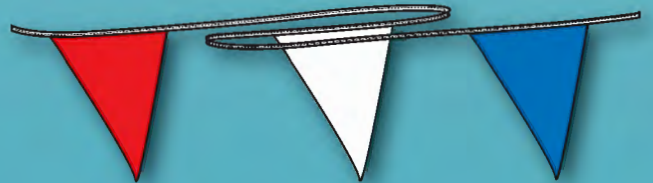

TH 1-6-5 Red-White-Blue



SS 100 Assorted Colors

Style SS

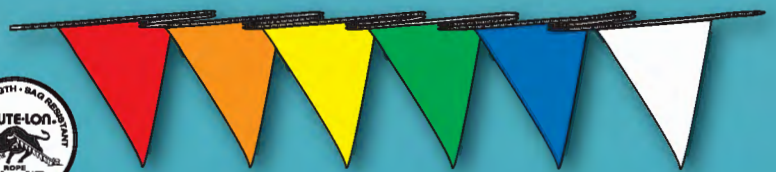

Style TH

TH 100 Assorted Colors

JUMBO POLY PENNANT STRINGS

4 MIL POLYETHYLENE PENNANTS

STYLE	LENGTH	1-20	21-50	51-100	101-250
J	30 FT	\$7.00	\$6.50	\$6.20	\$5.80
J	60 FT	\$11.00	\$10.50	\$10.00	\$9.45
J	105 FT	\$17.00	\$15.90	\$15.25	\$14.50



- ✓ 4 Mil Polyethylene Plastic
 - ✓ BIG 12"x18" Triangle Panels
 - ✓ 7 Colors To Mix & Match
 - ✓ You Build Color Combination!
 - ✓ Sag Resistant Brut-Lon™ Rope
 - ✓ 3 Popular Lengths
- Genuine Brut-Lon™ Construction**

* Not restockable.

J 30 FT 12 Panels
J 60 FT 24 Panels
J 105 FT 48 Panels

ORDER EXAMPLE: J 5-6-5 30
Color Pattern: Blue-White-Blue
Length: 30 Feet

ORDER EXAMPLE: J 1-6-5 60
Color Pattern: Red-White-Blue
Length: 60 Feet

BIG 12"x18"

Use Color Number(s) To Build String

Available Poly Colors

1 Red	5 Blue
2 Orange	6 White
3 Yellow	7 Black
4 Green	

Build Your Own Custom Color Combination!!

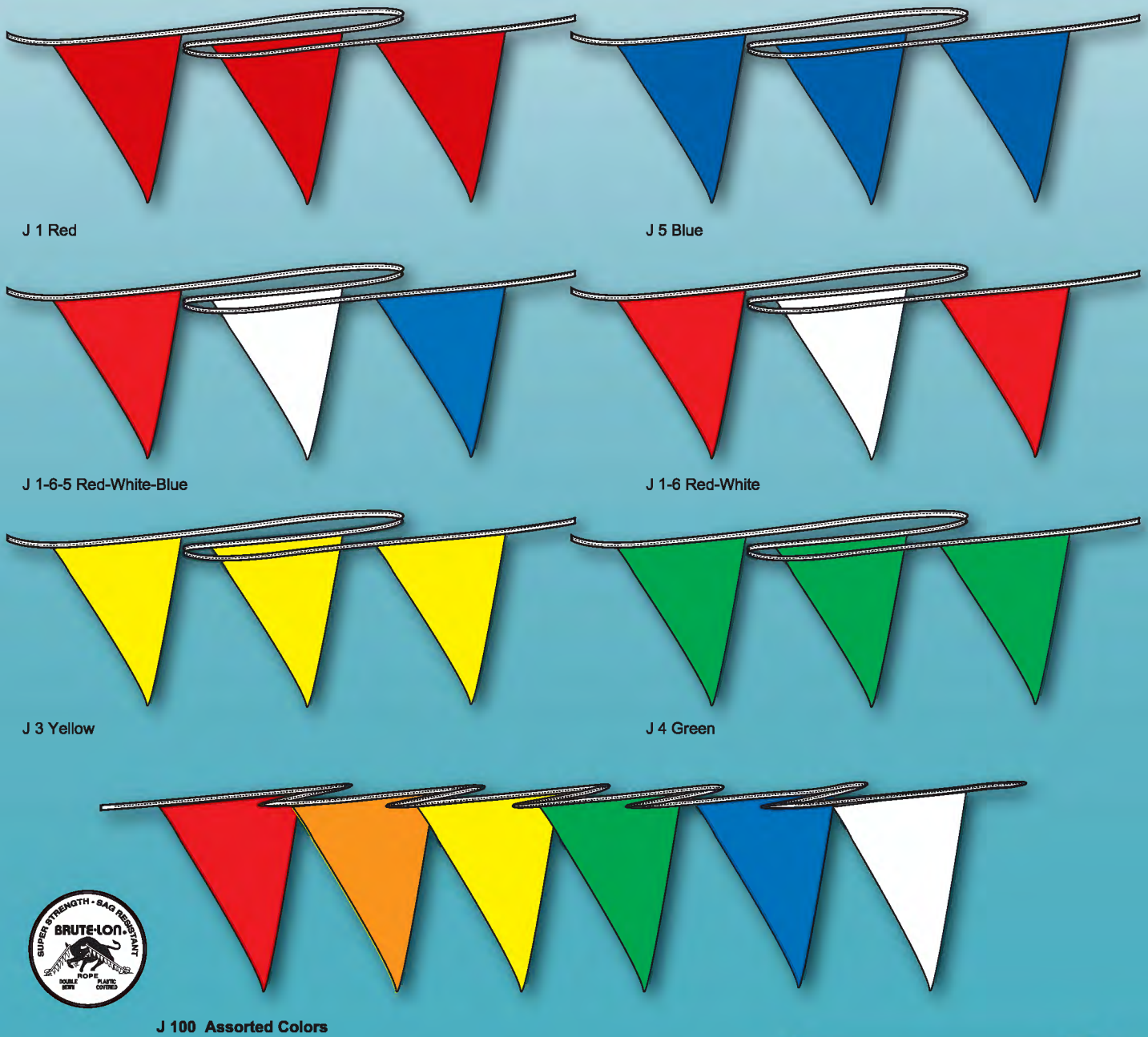

Custom Printed on page 17

GIANTS & ROCKETS PENNANT STRINGS

GIANTS & ROCKETS PENNANT STRINGS

STYLE	LENGTH	1-10	11-30	31-50	51-100	101-250
G	30 FT	\$18.58	\$18.03	\$17.75	\$17.20	\$16.65
G	60 FT	\$29.30	\$29.03	\$28.75	\$27.65	\$26.55
R	60 FT	\$24.00	\$23.75	\$22.25	\$21.75	\$20.80
R	100 FT	\$40.00	\$38.50	\$37.50	\$37.00	\$36.00

* Not restockable.

- ✓ 8 oz Plastic-Coated Vinyl
- ✓ 12"x18" Triangle Panels (Giants)
- ✓ 9"x12" Triangle Panels (Rockets)
- ✓ Fluorescent & Standard Colors Available
- ✓ You Build Color Combination!
- ✓ 5 Bright Fluorescent Colors
- ✓ 7 Standard Colors
- ✓ Sag Resistant Brut-Lon™ Rope

Genuine Brut-Lon™ Construction

G 30 12 Panels
G 60 24 Panels
R 60 36 Panels
R 100 64 Panels

ORDER EXAMPLE: G 5-3-5 60
Color Pattern: Standard Blue – Saturn Yellow – Standard Blue
Length: 60 Feet

ORDER EXAMPLE: R 3-8 100
Color Pattern: Saturn Yellow – Flame Pink
Length: 100 Feet



Use Color Number(s) To Build String
Standard Colors **Fluorescent Colors**

10 Red	1 Rocket Red
20 Orange	2 Blaze Orange
30 Yellow	3 Saturn Yellow
40 Green	4 Signal Green
5 Blue	8 Flame Pink
6 White	
7 Black	

Build Your Own Custom Color Combination!!

12"x18"
&
9"x12"

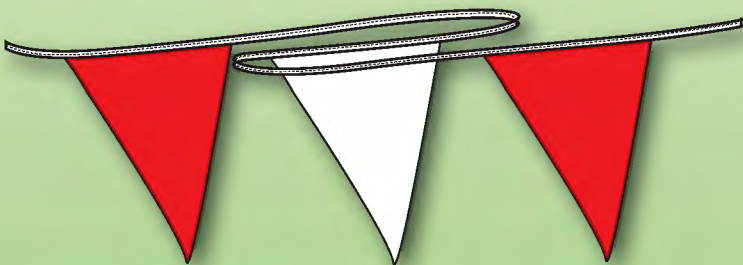

G 1-6-1 Red-White-Red

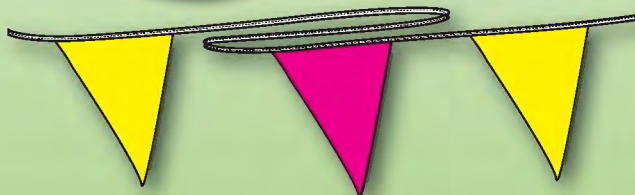

R 3-8 Yellow-Pink

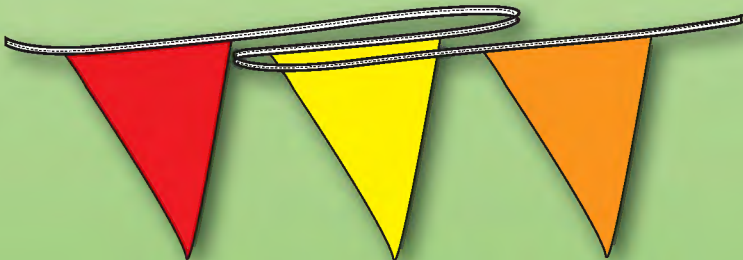

G 1-3-2 Red-Yellow-Orange

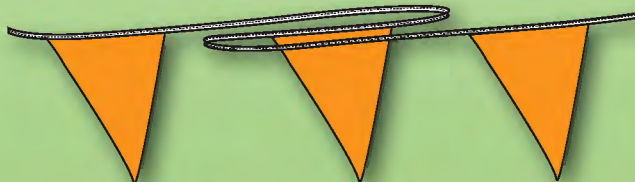

R 2 Blaze Orange

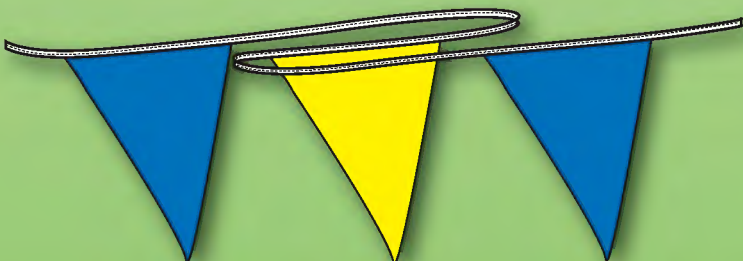

G 5-3-5 Blue-Yellow-Blue

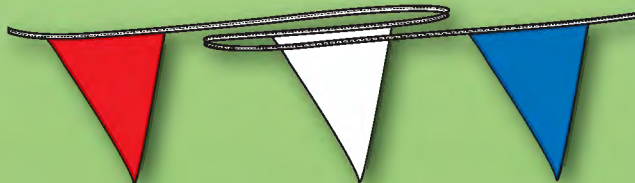

R 1-6-5 Red-White-Blue



G STYLE

G 100 Assorted Colors



R STYLE

R 100 Assorted Colors



BRILLIANT METALLIC PENNANT STRINGS

4 MIL POLYETHYLENE PENNANTS

STYLE	LENGTH	1-10	11-40	41-100	101-250
BM	60 FT	\$17.75	\$16.50	\$15.75	\$14.95

* Not restockable.

- ✓ Metallic
- ✓ 6"x18" Triangle Panels
- ✓ 10 Brilliant Colors To Mix & Match
- ✓ You Build Color Combination!
- ✓ Sag Resistant Brut-Lon™ Rope
- ✓ 60 Foot Lengths

Genuine Brut-Lon™ Construction



BM 60 40 Panels

ORDER EXAMPLE: BM 1-6-5
Color Pattern: Red-Silver-Blue
Length: 60 Feet

ORDER EXAMPLE: BM 5-6
Color Pattern: Blue-Silver
Length: 60 Feet

Sleek 6"x18"

BRILLIANT METALLIC!

Use Color Number(s) To Build String

Available Metallic Colors

1 Red	6 Silver
2 Orange	7 Turquoise
3 Gold	8 Purple
4 Green	9 Wineberry
5 Blue	10 Magenta

Build Your Own Custom Color Combination!!

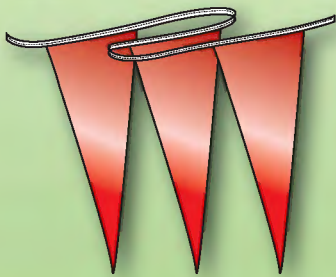

BM 1 Red

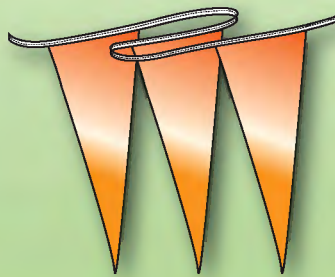

BM 2 Orange

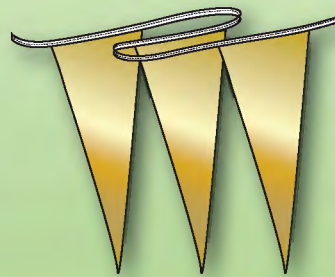

BM 3 Gold

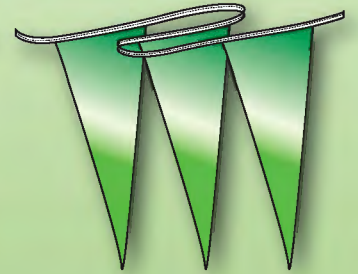

BM 4 Green

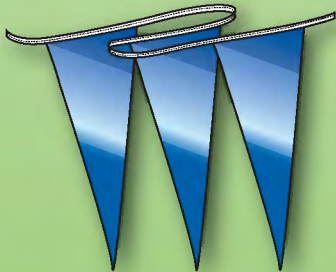

BM 5 Blue

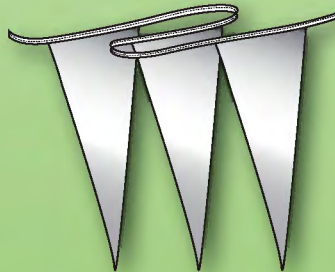

BM 6 Silver

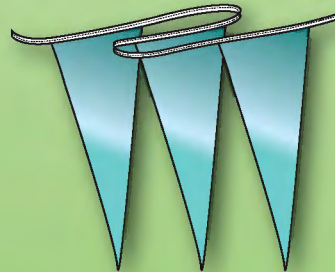

BM 7 Turquoise

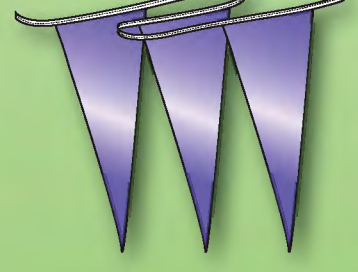

BM 8 Purple

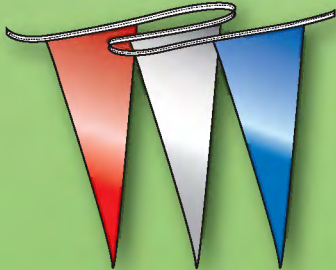

BM 1-6-5 Red-Silver-Blue

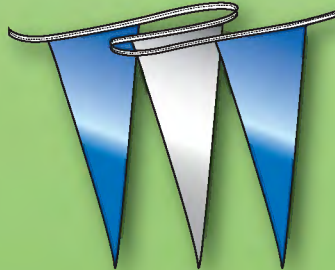

BM 5-6 Blue-Silver

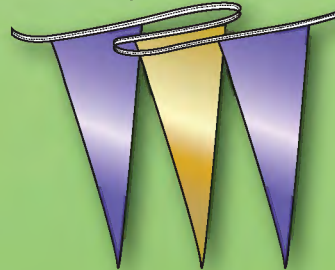

BM 8-3 Purple-Gold

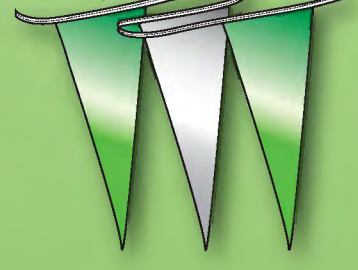

BM 4-6 Green-Silver

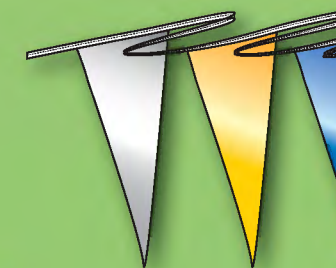

BM 100 Assorted Colors

SUNBURST METALLIC SQUARES!

BIG! 5 FT x 12 FT

**10
Brilliant
Colors**

- ✓ Metallic Finger-Cut Panels
- ✓ Big 5'x12' Design For High Visibility
- ✓ Eight Brilliant Metallic Strands Per Side
- ✓ All required hardware included
- ✓ Installs In Minutes
- ✓ 10 Fantastic Colors To Choose From
- ✓ Mix & Match Colors!
- ✓ Sag Resistant Brut-Lon™ Rope
- ✓ Built Tough
- ✓ 32 Total strings with 8 panels per string

**METALLIC
FINGER-CUT
SQUARES**

Available Colors

- | | |
|-------------|-------------|
| 1 Red | |
| 2 Orange | |
| 3 Gold | |
| 4 Green | |
| 5 Blue | 8 Purple |
| 6 Silver | 9 Wineberry |
| 7 Turquoise | 10 Magenta |

STYLE	2-4	5-8	9-+
MS	\$355.00	\$340.00	\$335.50



ORDER EXAMPLE: MS 5 -6
Color Pattern: Red (tops) – Gold (bottoms)

ORDER EXAMPLE: MS 1
Color Pattern: Red

SunBurst™



Bring Any Light Standard To Life With These Beautiful 5 foot x 12 foot metallic square display systems. Available in solid colors or multi-colored panels. \$20.00 refund on returned hardware.



FINGER-CUT METALLIC FRINGE PENNANTS

METALLIC FINGER-CUT FRINGE & STREAKING BULLET PENNANTS

STYLE	LENGTH	1-10	11-40	41-100	101-250
FM	30 FT	\$13.50	\$12.50	\$11.50	\$11.25
FM	60 FT	\$24.25	\$22.50	\$22.00	\$21.25
SB	30 FT	\$17.45	\$16.97	\$16.86	\$16.61
SB	60 FT	\$31.47	\$30.88	\$30.30	\$29.71



* Not restockable.

- ✓ Metallic (Finger-Cut)
 - ✓ Metallic & Plasti-Cloth (Streaking Bullets)
 - ✓ You Build Color Combination!
 - ✓ Sag Resistant Brut-Lon™ Rope
 - ✓ 60 Foot Lengths
- Genuine Brut-Lon™ Construction**

ORDER EXAMPLE: FM 5-6 60
Color Pattern: Blue-Silver
Length: 60 Feet

ORDER EXAMPLE: SB 6-3A 30
Color Pattern: Silver-Saturn Yellow
Length: 30 Feet

Use Color Number(s) To Build String

Metallic Colors		Fluorescent Colors
1 Red	6 Silver	1A Rocket Red
2 Orange	7 Turquoise	2A Blaze Orange
3 Gold	8 Purple	3A Saturn Yellow
4 Green	9 Wineberry	4A Signal Green
5 Blue	10 Magenta	8A Flame Pink



Streaking Bullets Combine Both Our Mylar Silver Metallic and Fluorescent Plastic-Cloth Vinyl On One Single String

Build Your Own Custom Color Combination!!



FM 5-6 Blue-Silver

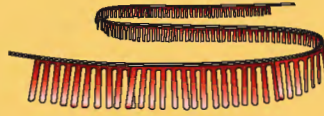

FM 1 Red



SB 6-3A Silver-Saturn Yellow



SB 6-8A Silver-Flame Pink



FM 2 Orange



FM 3 Gold



SB 6-4A Silver-Signal Green



SB 6-1A Silver-Rocket Red



FM 4 Green



FM 5 Blue



SB 6-2A Silver-Blaze Orange



SB 4A-6-8A Green-Silver-Pink



FM 6 Silver



FM 7 Turquoise



SB 4A-6-3A Green-Silver-Yellow



SB 2A-6-3A Orange-Silver-Yellow



FM 8 Purple

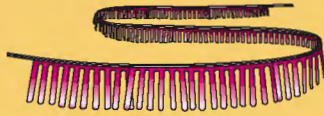

FM 9 Magenta

STREAKING BULLETS
 Select Up To 2 Fluorescent Colors To Alternate With Silver Panel

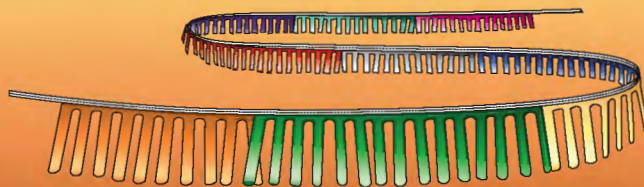

FULL CUT METALLIC FRINGE PENNANT STRINGS

METALLIC PENNANTS

STYLE	LENGTH	1-10	11-40	41-100	101-250
M	30FT	\$17.75	\$16.20	\$15.50	\$15.25
M	60FT	\$30.75	\$29.50	\$28.00	\$27.75

*NOT RESTOCKABLE



- ✓ Metallic
 - ✓ 12"x18" Fringe Panels
 - ✓ 10 Brilliant Colors To Mix & Match
 - ✓ You Build Color Combination!
 - ✓ Sag Resistant Brut-Lon™ Rope
 - ✓ 2 Popular Lengths
- Genuine Brut-Lon™ Construction**

ORDER EXAMPLE: M 1-6-5
Color Pattern: Red-Silver-Blue
Length: 60 Feet

ORDER EXAMPLE: M 5-6
Color Pattern: Blue-Silver
Length: 60 Feet

Build Your Own Custom Color Combination!!

Use Color Number(s) To Build String

Available Metallic Colors	
1 Red	6 Silver
2 Orange	7 Turquoise
3 Gold	8 Purple
4 Green	9 Wineberry
5 Blue	10 Magenta

M1 RED

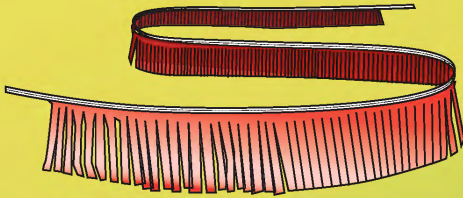

M2 ORANGE

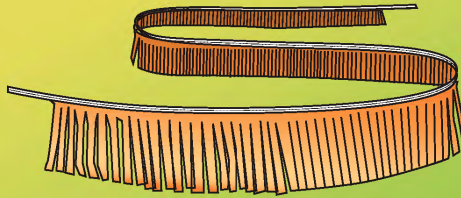

M3 GOLD

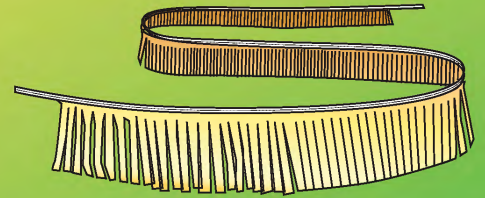

M4 GREEN

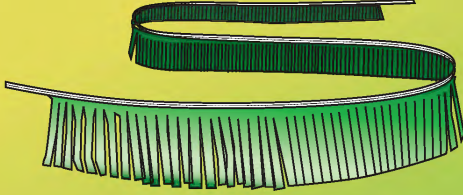

M5 BLUE

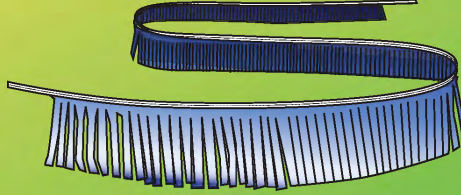

M6 SILVER

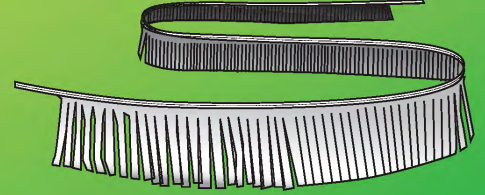

M7 TURQUOISE



M8 PURPLE



M9 WINEBERRY



M10 MAGENTA



COLOR SUGGESTIONS

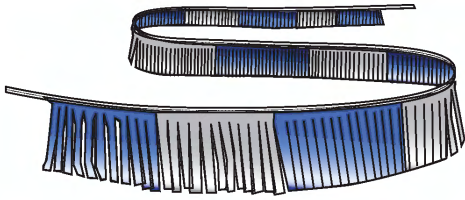

M 5-6-5 Blue-Silver Blue

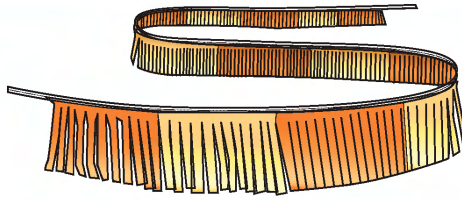

M 2-3-2 Orange-Gold-Orange

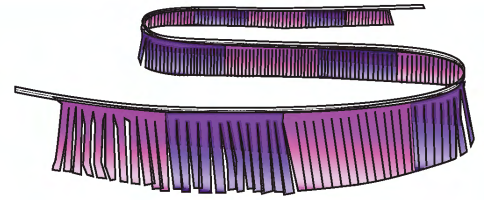

M 9-8 Wineberry-Purple

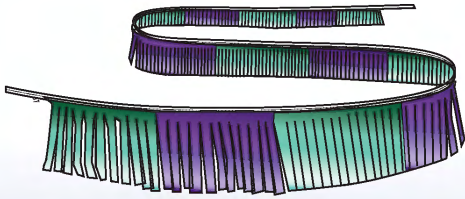

M 7-8 Turquoise_Purple

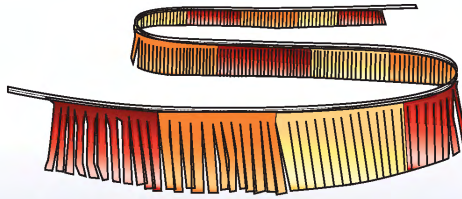

M 1-2-3 Red-Orange-Gold

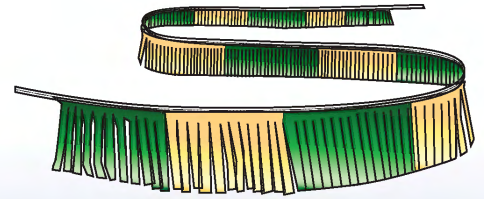

M 4-3-4 Green-Gold-Green

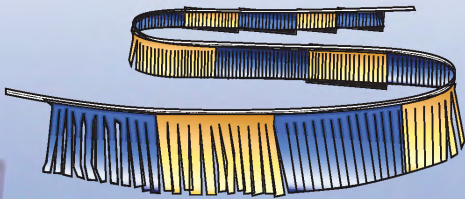

M 5-3-5 Blue-Gold-Blue

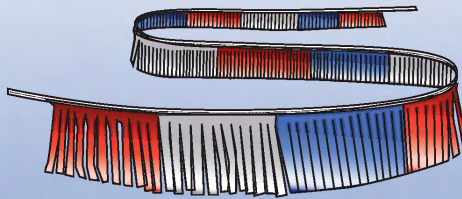

M 1-6-5 Red-Silver-Blue

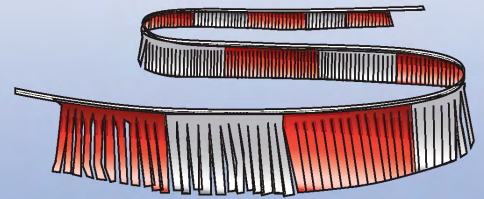

M 1-6 Red Silver

Color suggestions on this page are not stock items and cannot be returned for credit.



Available Metallic Colors

- 1 Red
- 2 Orange
- 3 Gold
- 4 Green
- 5 Blue
- 6 Silver
- 7 Turquoise
- 8 Purple
- 9 Wineberry
- 10 Magenta



FIESTA POLY FRINGE PENNANT STRINGS

4 MIL FRINGE POLYETHYLENE PENNANTS

STYLE	LENGTH	1-10	11-40	41-100	101-250
F	30 FT	\$10.50	\$ 9.75	\$ 9.25	\$ 9.00
F	60 FT	\$18.50	\$17.50	\$17.00	\$16.50

* Not restockable.

- ✓ 4 Mil Polyethylene Plastic
- ✓ 12"x18" Fringe Panels
- ✓ 7 Colors To Mix & Match
- ✓ You Build Color Combination!
- ✓ Sag Resistant Brut-Lon™ Rope
- ✓ 2 Standard Lengths

Genuine Brut-Lon™ Construction



ORDER EXAMPLE: F 5-6-5 30
Color Pattern: Blue-White-Blue
Length: 30 Feet

ORDER EXAMPLE: F 1-6-5 60
Color Pattern: Red-White-Blue
Length: 60 Feet



AVAILABLE POLY COLORS:

- | | |
|----------|---------|
| 1 Red | 5 Blue |
| 2 Orange | 6 White |
| 3 Yellow | 7 Black |
| 4 Green | |



F1 Red

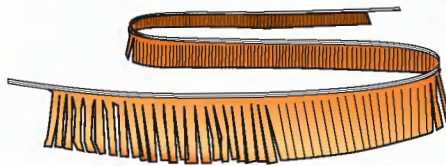

F2 Orange

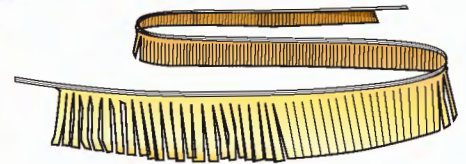

F3 Yellow



F 2-6-2 Orange-White-Orange

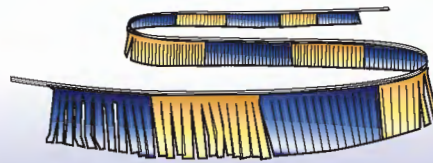

F 5-3-5 Blue-Yellow-Blue

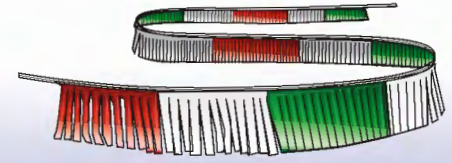

F 1-6-4 Red-White-Green

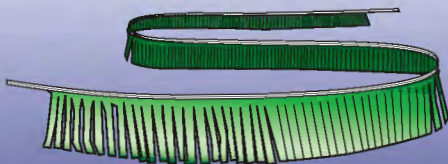

F 4 Green

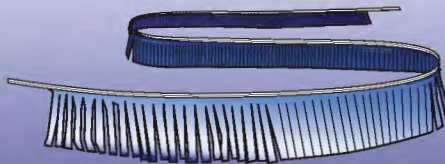

F 5 Blue

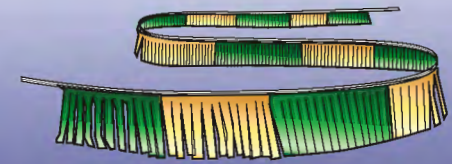

F 4-3-4 Green-Yellow-Green



F 1-3-1 Red-Yellow-Red



F 1-6-5 Red-White-Blue

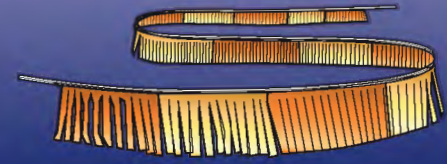

F 2-3-2 Orange-Yellow-Orange

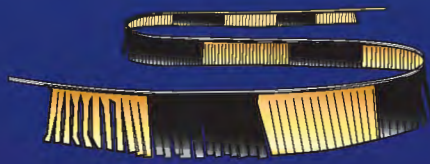

F 3-7-3 Yellow-Black-Yellow



F 6 White



F 7 Black



BRACKETS & HARDWARE

STYLE	1-25	25-50	51-100
SSUB	\$63.99	\$60.99	\$59.99 (C)
BAN	\$4.31	\$4.31	\$4.31 (C)

Single sided brackets will display one flag or banner and comes with 2 adjustable steel bands for quick installation. Requires two brackets, one for top & bottom bracket sleeves. Style BAN = Extra Band

STYLE	1-25	25-50	51-100
DSUB	\$68.99	\$65.99	\$63.99 (C)
BAN	\$4.31	\$4.31	\$4.31 (C)

Double sided brackets will display two flags or banners side by side and comes with 2 adjustable steel bands for quick installation. Requires two brackets, one for top & bottom bracket sleeves. Style BAN = Extra Band

Single sided and Double sided universal brackets are welded from high grade steel and mount to standard light poles are similar tubing with adjustable steel bands. High wind areas may require additional adjustable steel bands for added safety. Extra band style BAN see above price list.

HORIZONTAL POLE & BRACKET HARDWARE

Use our sturdy 5FT steel poles and pole brackets to mount horizontal flags in various applications. Choose from roof mount, vertical wall mount, or 45 degree wall mount orientations. 5FT steel pole comes with plastic end cap to reduce nylon fatigue. Optional ground socket available.

STYLE	1-25	25-50	51+
HWM	\$14.70	\$12.79	\$11.12 (C)
VWM	\$14.70	\$12.79	\$11.12 (C)
VRM	\$14.70	\$12.79	\$11.12 (C)
CFPR	\$14.70	\$12.79	\$11.12 (C)
SPL	\$10.25	\$9.89	\$9.52 (C)
GSA9	\$8.00	\$8.00	\$8.00 (C)

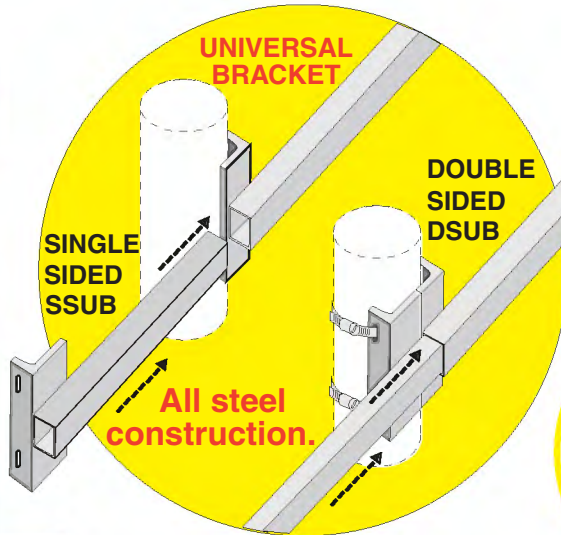

CLUSTER FLAG KIT

STYLE	1-10	11-15	16-25
CFK	\$235.00	\$199.99	\$189.99
BAN	\$4.31	\$4.31	\$4.31

CLUSTER FLAG

Cluster flag kits can be used with several flag styles, listed on lower left of page. Brackets & Banding will work on poles up to 8" diameter. All steel bracket, bands and poles.

* Order Example: CF-SDF1-SDF2-SDF3
Would include: 1 SDF1 Flag, 1 SDF2 Flag, and 1 SDF3 Flag

**Flags
Banners
Pennants
Table Drapes
Applique Flags
Feather Flags
Shark Fin Flags
Bracket Flags
Podium Banners
Net Banners
Mesh Banners
Nylon Banners
Pole Banners
Bracket Banners
Decals
Window Signs
Styrene Signs
Flag Poles
Full Color Printing**

THANK YOU!

FROM

NAB

2021

