



*Full color fabric printing made easy.*

# 2020-2021 Digital Catalog



The **QUINN** Family Thanks You For Putting Your Trust In Us!



## Full Color Fabric Printing Made Easy.

Originating in 1994, the QUINN family began as flag makers, but today is proud to be the largest provider of full color printed fabric products in the nation. You dream it, we can print it - soft-signage banners, flags, pennants, tents, trade show displays and more - quickly, easily, affordable and on-time.

### Want more?

This catalog is just a sampling of our new products and best sellers.  
View it all at [www.quinnflags.com](http://www.quinnflags.com).



**Pricing:** Please note that prices can change at any time. Visit [www.quinnflags.com](http://www.quinnflags.com) for the most up-to-date pricing and terms and conditions.

**Prop 65:** Quinn has done extensive testing on many of our products, fabrics and inks. Many of our products and most of our fabrics and inks comply with California's Proposition 65, also known as the Safe Drinking Water and Toxic Enforcement Act of 1986. However, due to the nature of our products having hardware, some of them require warning labels at this time. Quinn will continue to test hardware along with other items and as they pass, we will remove them from the list of items that require labeling. Please call us or visit [www.quinnflags.com](http://www.quinnflags.com) for the most up-to-date Proposition 65 information.





# Product Index

## New Health and Safety Products.....4

Disposable Face Masks.....	4
Fabric Face Masks and Covers.....	5
Fully Enclosed Tent.....	4
Health and Safety.....	6-7

## Outdoor and Promotional Flags.....8

Garden Banners.....	12
Golf Flags.....	12
Outdoor Knit Polyester Flags.....	9
Outdoor Polyester Pennants.....	11
Promotional 68D Polyester Flags.....	10
Racing Flags and Sets.....	11
Stick Flags.....	13
Vertical Outdoor Polyester Flags.....	10

## Table Covers and Runners.....14

Round Table Covers.....	16
Stretch Table Covers.....	17
Table Covers.....	15
Table Runners.....	16
Table Top Banners.....	17
Table Toppers.....	16

## Portable Banners and Kits.....18

Feather Flags.....	22
Half Drop & Teardrop Banners.....	19-20
Premium Banner Kits.....	20
Swooper Banners.....	21
Windchaser Flag Kits.....	23
Windsocks.....	21

## Tents.....24

Tents.....	25-26
------------	-------

## Advertising Banners, Wraps & Covers.....27

Advertising Banners.....	29
Giant Flagpole Kits.....	29
Marking and Utility Flags.....	33
Metal Desk Sets.....	33
Mini Teardrop Banners.....	34
Multi-Use Stretch Bands.....	32
Non-Woven Tote Bags.....	32
Podium Banners.....	30
Premium Podium Banners.....	31
Sunbrella™ Avenue Banners.....	28
Vinyl Avenue Banners.....	28

Sold exclusively through promotional product distributors and agencies.

- \* When acceptable artwork is submitted (see website for detail).
- \*\* Not available on all products. Additional charges will apply based on quantity, size and requested delivery date.
- \*\*\* Electronic versions only. Call factory for details.
- \*\*\*\* Lead time for Free virtuals is 3-4 days. Rush virtuals are available at an additional cost.

End-user friendly digital catalogs available. Contact factory for details.

## School Spirit.....35

Breakaway Banners.....	38
Fan Flags.....	37
Felt Banners.....	39
Felt Pennants.....	39
Premium Gonfalons.....	37
School Spirit Flags.....	38
Scroll Banners.....	37
Wearables.....	36

## Auto Accessories.....40

Car Stretch Products.....	40
Magnetic Car Flags.....	41
Promotional Car Flags.....	41
Traditional Car Flags.....	41

## Pennant Strings.....42

Pennant Strings.....	43
Polyethylene Pennant Strings.....	43

## Display Products.....44

Backdrop Banners.....	45
Backpack Flags.....	51
Booth in a Box.....	56-57
Collaboration Station.....	45
Custom Display Tables.....	52
Easy A-Frames.....	48
Illuminator Display Kits.....	53
Illuminator InstaStand Kits.....	53
InstaStands.....	52
Mini X-Banner Kits.....	50
Pop-Up Banners.....	51
Retractable Banner Stands.....	48
SlimFit Displays.....	49
Spring Wall Banners.....	47
Stretch Door Runners.....	46
Tower Stands.....	50
Trade Show Packages.....	54-55
Transformer Trunk Kit.....	52
Window Static Clings.....	46
X-Banner Kits.....	50

## American Flags & Stock Products.....58

Aluminum Flagpoles.....	61
Historical and Military Flags.....	62
Indoor Sets and Hardware.....	62
Message Flags.....	61
Patriotic American Flag Products.....	59
Pleated Fans.....	59
State and International Flags.....	62
U.S. Flags and Home Sets.....	60-61

## Quick Ship Products.....63

We are all in this together. **Quinn** is here to help you and **your business** during these unprecedented times.



Together we will get through this.

**NEW ITEMS!**

**Fully Enclosed Tent**

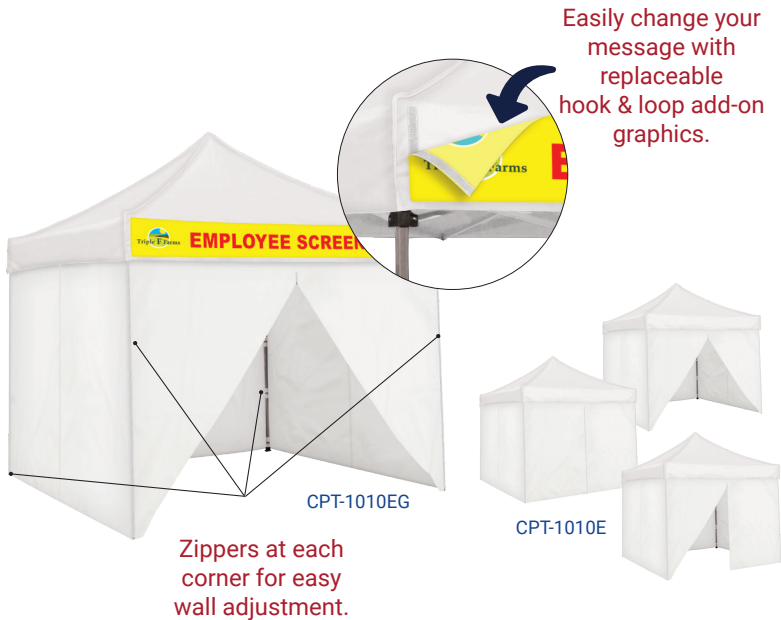

Easily change your message with replaceable hook & loop add-on graphics.

Zippers at each corner for easy wall adjustment.

**Markets:** Health Care, Safety  
**Uses:** Outdoor Presentations, Curbside Pickup, Temperature Checks

*Heavy Duty Fully Enclosed Tent ideal for testing, containment and screening. Sets up in minutes for rapid deployment.*

**Material:** 420D Polyester - PU Coated  
**Usage:** Outdoors  
**Production time:** Usually ships within 24 hours / CPT-1010EG and CPT-1010ERG: 7-10 business days  
**Finish:** Hemmed edges  
**Made in USA:** No  
**Prop 65 WARNING:** Cancer and/or Reproductive Harm. [www.P65Warnings.ca.gov](http://www.P65Warnings.ca.gov)

Includes aluminum pole frame, canopy, four walls (one with zipper in the center of the wall), stake and rope kit, and carrying case with wheels for easy travel and set-up.

Fully Enclosed Tent				
Item	Size	1	3	6
CPT-1010E	10' x 10'	830.00	745.00	690.00

Fully Enclosed Tent with Detachable Graphic				
Item	Size	1	3	6
CPT-1010EG	10' x 10'	945.80	833.20	757.95

Replacement Graphic for Fully Enclosed Tent						
Item	Size	1	3	6	12	25
CPT-1010ERG	10' x 10'	120.40	92.60	68.55	45.00	38.20

**Plain Protective Face Mask**



**3-Layer Protection System**

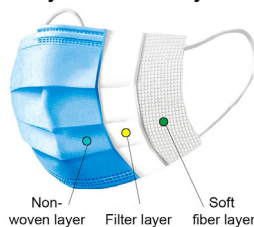

*These Plain Protective Disposable Face Masks include a 3-layer protection system that can help prevent breathing in harmful bacteria particles and virus droplets. They are intended to be used in an everyday environment and are NOT medical grade.*

**Material:** Non-Woven Fabric  
**Usage:** To be worn  
**Production time:** 3 business days  
**Finish:** Sewn around the edges  
**Made in USA:** No

Item	Size	100	500	1000	2000	3000	5000+
FM-PP	3.94in x 6.93in	830.00	745.00	690.00	1.10	1.05	1.00

## Face Masks and Covers

Face masks and face coverings are an essential health tool to help slow the spread of COVID-19 and other viruses.



### 1-ply Custom Microfiber Face Cover

*This single ply polyester/spandex microfiber is lightweight, breathable and moisture wicking.*

**Material:** Moisture Wicking Poly / Spandex Microfiber  
**Usage:** To be worn  
**Production time:** 7-10 business days  
**Finish:** Sewn around the edges with sewn-in flexible nose bridge and elastic  
**Made in USA:** Yes / FCI-CUSTOM are imported

Item	Size	6	12	25	50	100+
FC-WHITE / FM-BLACK / FM-USFLAG	9" x 6"	11.00	10.50	10.00	9.50	9.00
						R
Item	Size	25	50	100+		
FC-CUSTOM	9" x 6"	10.45	9.95	9.45		R
Item	Size	100	250	500	1000	2500
FCI-CUSTOM	9" x 6"	5.60	4.70	3.95	3.45	2.95
						R

### 2-ply Custom Microfiber Face Mask

*This 2 ply polyester/spandex microfiber face mask is lightweight, breathable and moisture wicking.*

**Material:** Moisture Wicking Poly / Spandex Microfiber  
**Usage:** To be worn  
**Production time:** 7-10 business days  
**Finish:** Sewn around the edges with sewn-in flexible nose bridge and elastic  
**Made in USA:** Yes / FMI-CUSTOM are imported



Item	Size	6	12	25	50	100+
FM-WHITE / FM-BLACK / FM-USFLAG	9" x 6"	11.50	11.00	10.50	10.00	9.50
						R
Item	Size	25	50	100+		
FM-CUSTOM	9" x 6"	10.90	10.45	9.95		R
Item	Size	100	250	500	1000	2500
FMI-CUSTOM	9" x 6"	6.10	5.10	4.35	3.85	3.25
						R

### 2-ply Premium Custom Fabric Face Mask

*The Premium Custom Fabric Face Mask is a 2ply reusable mask that is lightweight, breathable and water repellent.*

**Material:** Water Repellent Poly / Spandex Fabric with Moisture Wicking Poly / Spandex Microfiber Liner  
**Usage:** To be worn  
**Production time:** 7-10 business days  
**Finish:** Sewn around the edges with sewn-in flexible nose bridge and elastic  
**Made in USA:** Yes



Item	Size	6	12	25	50	100+
FMP-WHITE / FMP-BLACK / FMP-USFLAG	9" x 6"	12.15	11.50	11.00	10.50	10.00
						R
Item	Size	25	50	100+		
FMP-CUSTOM	9" x 6"	11.50	11.00	10.50		R

**All Microfiber Face Masks available in BLACK, WHITE, AND U.S. FLAG**



**Fabric ties available for an additional fee. Contact us for details.**



## Why are Quinn Masks the BEST MASKS?



**No ear fatigue!** (Callout to the neck strap)

**Always forgetting your mask? Elastic straps keep your mask close** (Callout to the neck strap)

**Sewn-in flexible nose bridge** (Callout to the nose bridge)

**Full color message/logo is always on display** (Callout to the mask's front)

**Universal fit • Reusable • Machine washable • Breathable**



**Quinn** offers a variety of items that essential businesses may be in need of right now. All custom products include full color digital printing... **AT NO EXTRA COST!**



Canopy Tents



Bandanas



Car Flags



Portable Banners



Windchaser Flags



Swooper Banners



Feather Flags



Outdoor Flags

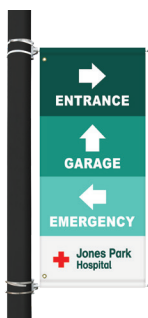

Vinyl Avenue Banners



Garden Banners



Giant Flagpoles



Knit Polyester Banners



Fully Enclosed Tent



Plain Protective Face Mask



Multifunctional Headwear



Face Masks and Covers



Table Covers and Runners



Easy A-Frames



A-Frame Sandwich Boards



Door Runners



SlimFit Steel Bases



Mini Teardrop Banners



Backdrop Banners



SlimFit Walls

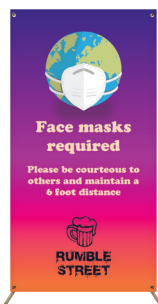

X-Banners



Felt Pennants



Podium Banners



American Flags





## Outdoor and Promotional Flags

***Put your brand on something  
that's built to get noticed!***

**When determining which flag best suits your client's needs...**

**Where will it be used?** – A durable knit polyester is used for long-term outdoor uses and a lighter weight 68D polyester is great for giveaways, indoor use and when a lower price point is needed.

**How will it be used/displayed?** – Flags can be finished in many ways to accommodate any display (i.e. heading and grommets for flag poles, pole sleeve to display vertically, sewn in rope for extra durability, etc...). Let us know how it will be displayed, and we will suggest the perfect finish!

**How should messaging be presented?** – A single reverse flag is 1-layer printed on 1 side and bleeds through to the other side creating a mirror image of the design. A double-sided flag is 3-layers that includes 2 prints sewn together with a block-out liner.

**What size?** – Size is generally determined by the size of the display area and/or price. Our DPP-35 3x5' flag is the most popular best seller! If needed for a flagpole, guidelines are that the length of the flag should be 1/4 to 1/3 the length of the flagpole.



## Outdoor Knit Polyester Flags



- No Minimums
- Top Quality & Durability
- Any Shape & Size
- Nylon Flags Also Available

Single Reverse reads correct on one side & reversed on the backside. Double Sided reads correct on both sides and has a block-out liner in the center.

These flags are finished with heading & grommets.

**Markets:** Used in Every Market

**Uses:** Branding, Logo Recognition, Awareness, Attention Getting, Flagpole Display, Indoor Display, Giveaways

*Feel the power of branded flags.*

**Material:** Knit Polyester  
**Usage:** Outdoors  
**Production time:** 7-10 business days  
**Finish:** Fully hemmed on all sides; canvas heading and brass grommets; rope and thimble for flags larger than 6' x 10'; pole sleeve available  
**Made in USA:** Yes

Single Reverse						
Item	Size	1	3	6	12	25
DPP-12	12" x 18"	62.35	58.10	28.65	21.10	13.10
DPP-16	16" x 24"	68.60	64.35	37.40	23.60	15.60
DPP-23	2' x 3'	99.85	73.10	49.85	28.60	23.60
DPP-24	2.5' x 4'	112.35	85.60	62.35	36.10	29.85
DPP-35	3' x 5'	124.35	99.90	73.10	43.60	36.10
DPP-46	4' x 6'	149.85	123.10	98.00	74.35	56.85
DPP-58	5' x 8'	249.35	173.40	149.35	117.75	78.10
DPP-610	6' x 10'	280.00	198.10	168.10	140.00	105.00

Double Sided						
Item	Size	1	3	6	12	25
DPP-12D	12" x 18"	78.60	73.10	39.35	27.25	20.60
DPP-16D	16" x 24"	83.60	78.10	48.10	31.00	24.35
DPP-23D	2' x 3'	112.35	90.60	65.10	38.65	33.60
DPP-24D	2.5' x 4'	138.99	115.25	85.99	48.60	41.75
DPP-35D	3' x 5'	165.60	139.90	106.85	58.50	49.85
DPP-46D	4' x 6'	203.10	168.10	137.50	108.10	86.85
DPP-58D	5' x 8'	300.00	261.55	223.10	182.50	130.60

**TOP SELLER!**

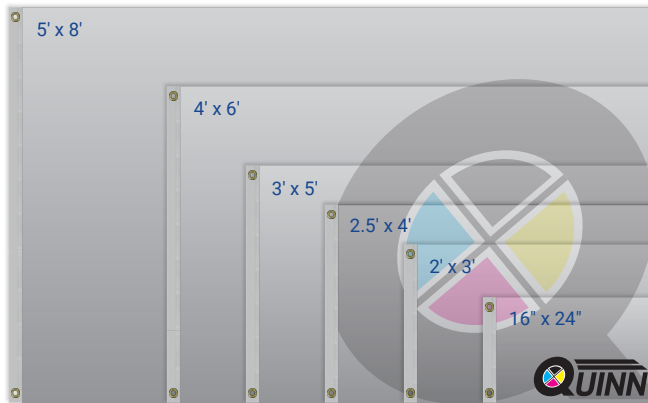

Large Single Reverse Flags				
Item	Size	1	3	12
DPP-812	8' x 12'	406.25	286.85	218.75
DPP-1015	10' x 15'	531.25	390.60	286.85
DPP-1218	12' x 18'	622.50	490.60	423.10
DPP-1525	15' x 25'	950.00	743.10	618.75
DPP-2030	20' x 30'	1,256.75	991.45	920.65

**Prop 65 WARNING:** Cancer and/or Reproductive Harm. [www.P65Warnings.ca.gov](http://www.P65Warnings.ca.gov). This only applies to the larger flags.

## Aluminum Spinner Pole with Ball Top

Our revolutionary pole keeps your flag from wrapping around the pole. The flagpole features a top section that spins freely on a set of ball bearings, allowing the flag to stay unwrapped. Measuring 1" in diameter, the pole includes a simple ball top and 2 clear EZ-Mount (TM) rings. Please be advised the 6' spinner will only work with flags 3' x 5' or smaller.

Item	Size	Color	1	12+
SP-205	6'	Silver	21.25	20.10
SP-305	6'	White	22.75	20.40



## Adjustable Aluminum Bracket

Display your logo to gain maximum visibility with the help of this adjustable aluminum bracket! This simple bracket features an adjustable angle and comes with a convenient thumb screw. Designed for flag poles that are 1" in diameter, it makes a great alternative where floor sidewalk or street space may be limited.

Item	Color	1	48+
SLB-110	Silver	11.50	10.25
SLB-115	White	11.50	10.25



SLB-110

SLB-115

SP-205

SP-305

## Promotional 68D Polyester Flags

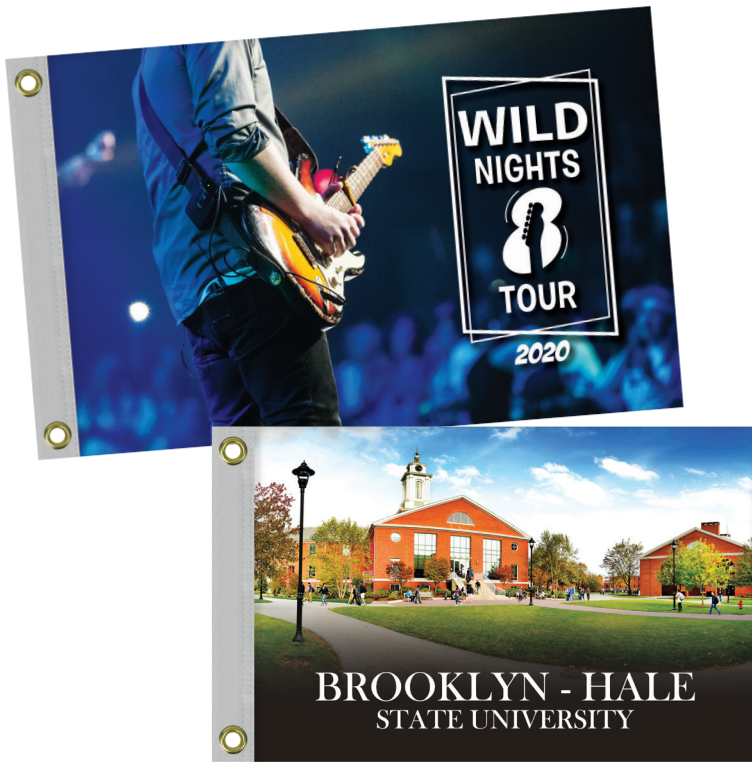

**Markets:** Event Marketing , Sports Teams, Schools

**Uses:** Events, Giveaways, Promotions

*These single reverse flags are great for giveaways, advertising campaigns and events.*

**Material:** 68D Polyester

**Usage:** Indoors

**Production time:** 7-10 business days

**Finish:** Fully hemmed on all sides; canvas

heading and brass grommets; pole sleeve available

**Made in USA:** No

Single Reverse						
Item	Size	50	100	250	500	1,000
DPP-68-23	2' x 3'	13.25	10.15	8.15	6.54	5.85
DPP-68-24	2.5' x 4'	19.20	13.55	11.55	9.75	8.25
DPP-68-35	3' x 5'	21.55	16.34	13.90	12.90	11.60
DPP-68-46	4' x 6'	30.25	23.60	21.25	19.10	17.25

R

## Vertical Outdoor Polyester Flags



**Markets:** Safety, Schools, Sports, Teams, Businesses

**Uses:** Auditorium Displays, Award Displays, Outdoor Display, Giveaways

*Vertical Banners are just like our high quality Outdoor Polyester Flags, except they hang vertically instead of horizontally.*

**Material:** Knit Polyester

**Usage:** Outdoors/ Indoors

**Production time:** 7-10 business days

**Finish:** Fully hemmed on all sides;

canvas heading and brass grommets;

pole sleeve available

**Made in USA:** Yes



Single Reverse reads correct on one side & reversed on the backside. Double Sided reads correct on both sides and has a block-out liner in the center.

Single Reverse						
Item	Size	1	3	6	12	25
DPPB-23	2' x 3'	99.85	73.10	49.85	28.60	23.60
DPPB-24	2.5' x 4'	112.35	85.60	62.35	36.10	29.85
DPPB-35	3' x 5'	124.35	99.90	73.10	43.60	36.10
DPPB-46	4' x 6'	149.85	123.10	98.00	74.35	56.85

R

Double Sided						
Item	Size	1	3	6	12	25
DPPB-23D	2' x 3'	112.35	90.60	65.10	38.65	33.60
DPPB-24D	2.5' x 4'	138.99	115.25	85.99	48.60	41.75
DPPB-35D	3' x 5'	165.60	139.90	106.85	58.50	49.85
DPPB-46D	4' x 6'	203.10	168.10	137.50	108.10	86.85

R

## Outdoor Polyester Pennants

**Markets:** Boats, Marinas

**Uses:** Events, Giveaways, Boat Display

*Pennant shaped flags are most popular for their use at marinas and on boats, but their eye-catching shape is sure to attract attention anywhere.*



**Material:** Knit Polyester  
**Usage:** Outdoors  
**Production time:** 7-10 business days  
**Finish:** Fully hemmed on all sides; canvas heading and brass grommets; pole sleeve available  
**Made in USA:** Yes

Single Reverse reads correct on one side & reversed on the backside. Double Sided reads correct on both sides and has a block-out liner in the center.

Single Reverse						
Item	Size	1	3	6	12	25
DPP-12TRIS	12" x 18"	62.35	58.10	28.65	21.10	13.10
DPP-16TRIS	16" x 24"	68.60	64.35	37.40	23.60	15.60
DPP-23TRIS	2' x 3'	99.85	73.10	49.85	28.60	23.60
DPP-24TRIS	2.5' x 4'	112.35	85.60	62.35	36.10	29.85
DPP-35TRIS	3' x 5'	124.35	99.90	73.10	43.60	36.10
DPP-46TRIS	4' x 6'	149.85	123.10	98.00	74.35	56.85
DPP-58TRIS	5' x 8'	249.35	173.40	149.35	117.75	78.10

Double Sided						
Item	Size	1	3	6	12	25
DPP-12TRID	12" x 18"	78.60	73.10	39.35	27.25	20.60
DPP-16TRID	16" x 24"	83.60	78.10	48.10	31.00	24.35
DPP-23TRID	2' x 3'	112.35	90.60	65.10	38.65	33.60
DPP-24TRID	2.5' x 4'	138.99	115.25	85.99	48.60	41.75
DPP-35TRID	3' x 5'	165.60	139.60	106.85	58.50	49.85
DPP-46TRID	4' x 6'	203.10	168.10	137.50	108.10	86.85
DPP-58TRID	5' x 8'	300.00	261.55	223.10	182.50	130.60

## Racing Flags and Sets

**Markets:** Racing Events, Fundraisers, Tournaments

**Uses:** Communicating, Signage Display, Giveaways, Sponsorships

*Ideal for communicating with drivers during any exciting car race or as a gift for any racing fan. Perfect way to make a lasting impression!*

**Material:** Polyethylene / Rayon  
**Usage:** Outdoors  
**Production time:** Stock item  
**Finish:** Pole sleeve  
**Made in USA:** Yes  
**Prop 65 WARNING:** Cancer and/or Reproductive Harm. [www.P65Warnings.ca.gov](http://www.P65Warnings.ca.gov)



Black and White Checkered				
Item	Length	2	25	50
CTS-30	30"	9.50	7.85	7.30
CTS-60	60"	15.00	14.50	14.20
CTS-100	100"	24.50	23.20	22.95



Mounted Auto Racing Mini Desk Set of 7			
Item	Size	1	12+
MS-107	4" x 5"	24.50	22.00



Item	Size	Type of flag	Finish	1	6	12
IRU-210	24" x 30"	Yellow Caution	Pole sleeve only	27.00	25.50	24.50
IRM-110	24" x 30"	Yellow Caution	Wood staff incl.	29.00	27.25	26.35
IRU-215	24" x 30"	Black Leave track	Pole sleeve only	27.00	25.50	24.50
IRM-115	24" x 30"	Black Leave track	Wood staff incl.	29.00	27.25	26.35
IRU-230	24" x 30"	White One Lap to Finish	Pole sleeve only	27.00	25.50	24.50
IRM-130	24" x 30"	White One Lap to Finish	Wood staff incl.	29.00	27.25	26.35
IRU-205	24" x 30"	Green Start Race	Pole sleeve only	27.00	25.50	24.50
IRM-105	24" x 30"	Green Start Race	Wood staff incl.	29.00	27.25	26.35
IRU-220	24" x 30"	Red Stop Flag	Pole sleeve only	27.00	25.50	24.50
IRM-120	24" x 30"	Red Stop Flag	Wood staff incl.	29.00	27.25	26.35
IRU-225	24" x 30"	Blue Move to Outside	Pole sleeve only	27.00	25.50	24.50
IRM-125	24" x 30"	Blue Move to Outside	Wood staff incl.	29.00	27.25	26.35
IRU-235	24" x 30"	Checked End of Race	Pole sleeve only	27.00	25.50	24.50
IRM-135	24" x 30"	Checked End of Race	Wood staff incl.	29.00	27.25	26.35

Racing Flag Set Includes all 7 flags					
Item	Size	Finish	1	3	
ARM-2430	24" x 30"	Wood staff included	159.50	149.50	

Custom race flags available upon request. Contact us for details.



## Garden Banners



**Markets:** Teams, Schools, Homes, Political, Businesses

**Uses:** Spirit, Awareness, Advertising

*Best quality and customizable garden banners will create a striking display in a wide variety of public areas.*

**Material:** Knit Polyester  
**Usage:** Outdoors  
**Production time:** 7–10 business days  
**Finish:** Fabric pole sleeve  
**Made in USA:** Yes  
**Prop 65 WARNING:** Cancer and/or Reproductive Harm. [www.P65Warnings.ca.gov](http://www.P65Warnings.ca.gov)

Rectangle Banners							
Item	Size	Sides	1	3	6	12	25
GB-1218	12" x 18"	Single Reverse	62.40	58.15	28.70	21.15	13.15
GB-1218D	12" x 18"	Double Sided	78.65	73.15	39.40	27.25	20.65
GB-1420	14" x 20"	Single Reverse	64.40	60.15	30.70	23.15	15.15
GB-1420D	14" x 20"	Double Sided	80.65	75.15	41.40	29.25	22.65

Hardware					
Item	Size	1	6	12	24+
GB-HARDWARE	Fits 12" x 18" & 14" x 20"	13.00	12.50	12.00	11.50



\*Hardware Imported

## Golf Flags



**Markets:** Golf, Fundraisers

**Uses:** Events, Tournaments, Sponsorships

*Score a hole in one at your next event with golf flags. Great for giveaways at golf courses & tournaments! Nylon material available upon request.*

**Material:** Knit Polyester  
**Usage:** Outdoors  
**Production time:** 7–10 business days  
**Finish:** Fully hemmed on all sides; canvas heading and brass grommets or sewn in golf tube  
**Made in USA:** Yes  
**Prop 65 WARNING:** Cancer and/or Reproductive Harm. [www.P65Warnings.ca.gov](http://www.P65Warnings.ca.gov)

Single Reverse Flags							
Item	Size	Finish	1	3	6	12	25
GFGS-1420	14" x 20"	Heading & grommets	80.85	54.90	31.90	19.90	12.45
GFTS-1420	14" x 20"	Golf Tube	83.15	57.40	41.90	27.40	19.70

Double Sided Flags							
Item	Size	Finish	1	3	6	12	25
GFGD-1420	14" x 20"	Heading & grommets	86.90	61.15	37.40	26.50	18.70
GFTD-1420	14" x 20"	Golf Tube	98.15	64.40	45.65	31.75	24.70



### Available Finishes



3/4" Golf Tube  
(Fits standard 3/4" diameter golf pole)

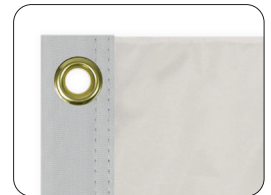

Heading & Grommets



## Embroidered Golf Flags Also Available!

## Appliquéd and Embroidered Flags

When small quantities of a custom flag are required and the design is relatively simple, the appliqué or embroidery process may be the perfect choice. Both are durable and showcase your design in the best possible way. The complexity of the artwork determines the price and availability since appliqué flags are cut and sewn by hand, while embroidered flags are digitized and finished by hand. Unlike digitally printed flags, appliqué and embroidered flags cannot show any gradients or shading, only spot colors.



Appliquéd



Embroidered

## Stick Flags

**Markets:** Sports, Awareness, Collegiate, Businesses

**Uses:** Desk Sets, Parades, Giveaways, Markers, Handheld

Increase audience participation by passing these out at speeches, rallies, holiday parties and much more.

**Material:** Polyester  
**Usage:** Outdoors / Indoors  
**Production time:** 7-10 business days  
**Finish:** Heat cut edges / 8 x 12" and larger or double sided are finished with hemmed edges  
**Made in USA:** No  
**Prop 65 WARNING:** Cancer and/or Reproductive Harm. [www.P65Warnings.ca.gov](http://www.P65Warnings.ca.gov)



Example:  
 All custom polyester and nylon stick flag materials (excluding staff) are flexible and will not remain vertical when held upright.

**Plastic & Wooden Bases Available!**  
 Perfect way to display your stick flags.



MFB-16PBK



MFB-16PBG

\*Plastic bases not for use with these sizes

Single Reverse						
Item	Size	25	50	100	250	500
DPSF-461001	4" x 6"	8.40	5.70	4.15	2.68	1.88
DPSF-691001	6" x 9"	9.60	5.88	4.45	3.05	2.02
DPSF-8121001	8" x 12" *	9.98	7.35	4.90	3.55	2.75
DPSF-12181001	12" x 18" *	13.25	7.95	6.80	4.75	3.60
DPSF-16241001	16" x 24" *	15.25	11.40	8.50	6.40	5.20

Double Sided						
Item	Size	25	50	100	250	500
DPSF-461002	4" x 6" *	10.20	6.10	4.90	3.40	2.48
DPSF-691002	6" x 9" *	11.15	7.45	6.45	4.45	3.45

## Stick Flags with Plastic Liner

Want your flags to remain upright?! We have the perfect solution for you. Our new stick flags with plastic liners will make sure your brand stands out always!

Double Sided						
Item	Size	100	250	500	1000	2500
DPSF-46DL	4x6	5.70	4.05	2.85	2.10	1.65



Please note plastic liner is clear so it does not block out image on opposite side.

**NEW!**

## Stick Flags Sets

Show off your brand with this desktop decoration! Combined with our new weighted base gives customers just what they've been asking for!

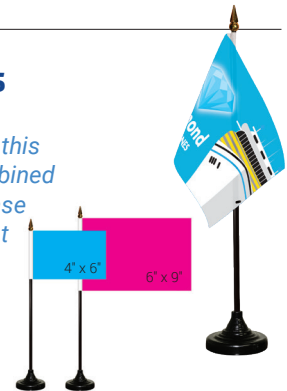

Single Reverse						
Item	Size	100	250	500	1000	2500
DPSF-461GWB	4" x 6"	8.30	7.15	5.30	4.00	3.60
DPSF-462GWB	6" x 9"	9.00	7.90	5.90	4.75	4.30

Double Sided						
Item	Size	100	250	500	1000	2500
DPSF-691GWB	6" x 9"	8.75	7.55	5.45	4.40	3.90

## U.S. Imprinted 10" Wooden Staff

Show some patriotism with the 4" x 6" U.S. cotton flag on an imprinted 10" wooden staff! Customize with a personal message, corporate slogan, or company name on the convenient wooden stick.

Item	Size	1000	2500	5000+
ECS-46P	4" x 6"	0.86	0.73	0.67



**Stick Flags with Imprinted Wooden Staffs**

## Custom Imprinted Wooden Staff

Customize with any art! It's made using polyester materials and features heat cut edges a pole sleeve and a 10" natural wooden staff capable of supporting 36 characters.

Item	Size	1000	2500	5000	10000+
DPSF-CUSTOMP	4" x 6"	1.50	1.15	0.93	0.85







Photograph by Normand Huberdeau

## Table Covers and Runners

### *Have the most professional table top display with full color graphics and top-quality fabrics!*

**When determining which Table Cover or Runner best suits your client's needs...**

**Where will it be used?** – Stretch and fitted table covers are ideal for outdoor use since wind will not impact the display as they would with throws and runners.

**How will it be used/displayed?** – Different finish options are available if storing objects under the table, such as an open back 3-sided option or sewn in zipper for easier access, and a convertible table cover can fit 6' and 8' tables.

**How should messaging be presented?** – Full color printing anywhere on the table cover or runner provides optimal messaging. **Our unique easy to use pricing makes our table covers easy to sell since price is the same regardless of art, material and finish for each size!**

**What size?** – It is important to know not only the length of the table but also the width. Standard widths for 6' and 8' tables are 30" width for 4', 6' and 8' tables.



## Table Throws

# TRADITIONAL

# BEST SELLER!



**Pay One Low Price Regardless of Style, Finish or Artwork\***

**Markets:** Financial, Trade Show, Events

**Uses:** Branding, Awareness, Advertising, Special Occasions

*Ideal for a wide variety of events and occasions. Custom sizes also available.*

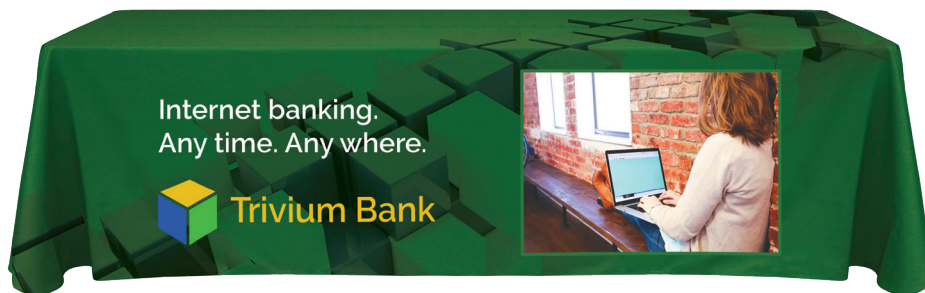

**Material:** Premium Polyester

**Usage:** Indoors / Short-term Outdoors

**Production time:** 7-10 business days

**Finish:** Fully hemmed on all sides

**Made in USA:** Yes

**Prop 65 WARNING:** Cancer and/or Reproductive Harm. [www.P65Warnings.ca.gov](http://www.P65Warnings.ca.gov) (zipper only / item DTCFZ)



Full Back (DTC)



Open Back (DTCOB)

Throw Style			1	3	6	12	25
DTC-4F / DTCOB-4	4'	Full / Open	245.00	178.60	143.85	105.60	90.10
DTC-6F / DTCOB-6	6'	Full / Open	255.00	230.00	200.50	175.00	125.00
DTC-8F / DTCOB-8	8'	Full / Open	275.00	250.00	220.00	190.00	135.00

R

## Fitted Table Covers

**Convenient clear zippered plastic bag included with every table cover of quantities 25+**



Full Back (DTCF)



Open Back (DTCFOB)



Zipper Back (DTCFZ)

Fitted Style			1	3	6	12	25
DTCF-4F / DTCFOB-4 / DTCFZ-4	4'	Full / Open / Zipper	245.00	178.60	143.85	105.60	90.10
DTCF-6F / DTCFOB-6 / DTCFZ-6	6'	Full / Open / Zipper	255.00	230.00	200.50	175.00	125.00
DTCF-8F / DTCFOB-8 / DTCFZ-8	8'	Full / Open / Zipper	275.00	250.00	220.00	190.00	135.00

R

\* Price varies by size only

## Table Runners

*Ideal for a wide variety of events and occasions. Custom sizes are also available.*



**Material:** Premium Polyester  
**Usage:** Indoors / Short-term Outdoors  
**Production time:** 7-10 business days  
**Finish:** Fully hemmed on all sides  
**Made in USA:** Yes



Item	Size	1	3	6	12	25
DTCR-3060	30" x 60"	103.15	81.25	73.15	57.40	49.50
DTCR-3072	30" x 72"	124.40	103.15	85.65	69.90	58.50
DTCR-3084	30" x 84"	143.75	120.25	101.75	82.40	69.75
DTCR-3090	30" x 90"	155.00	128.15	106.25	88.65	75.50
DTCR-6060	60" x 60"	195.00	165.00	137.50	116.15	100.65
DTCR-6072	60" x 72"	233.15	193.15	165.00	136.15	118.00
DTCR-6090	60" x 90"	292.50	242.75	199.90	165.65	147.50

R

## Round Table Covers



*Demand attention and draw crowds to your table at conventions, conferences and trade shows.*

**Material:** Premium Polyester / Stretch Polyester  
**Usage:** Indoors / Short-term Outdoors  
**Production time:** 7-10 business days  
**Finish:** Fully hemmed on all sides  
**Made in USA:** Yes



**Solid Colors are also available!**

**Price Includes Full Color Anywhere on the Cover**

Throw						
Item	Diameter	1	5	10	25	50
DTC-30R	30"	264.00	134.00	101.00	75.00	64.00

R

Stretch						
Item	Size	1	3	6	13	25
DTCS-23R	23.6" x 29.1"	216.00	125.65	106.50	78.25	60.95
DTCS-30R	31.9" x 29.1"	226.00	128.45	109.30	79.25	62.65
DTCS-31R	31.9" x 43.3"	256.00	149.85	112.35	92.40	74.85
DTCS-37R	37.4" x 28.7"	248.00	138.60	108.70	86.35	66.90

R

FITTED						
Item	Size	1	3	6	13	25
DTCF-23R	23.6" x 29.1"	226.00	125.65	109.30	79.25	62.65
DTCF-31R	31.9" x 43.3"	256.00	149.85	112.35	86.40	74.85
DTCF-37R	37.4" x 28.7"	248.00	138.60	108.70	86.35	66.90

R

## Table Toppers



*Perfect for giving a professional touch to any presentation, company picnic, trade show or fundraiser.*

**Material:** Polyester  
**Usage:** Indoors / Short-term Outdoors  
**Production time:** 7-10 business days  
**Finish:** Fully hemmed on all sides  
**Made in USA:** Yes



Item	Size	1	3	6	13	25
DTCTTS-4	4'	191.20	96.70	77.65	58.30	44.10
DTCTTS-6	6'	205.00	118.10	92.70	68.20	54.25
DTCTTS-8	8'	228.00	138.60	106.05	83.55	69.45

R

## Stretch Table Covers



Full Back (DTCS)

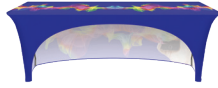

Open Back (DTCSOB)

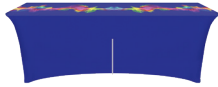

Zipper Back (DTCSZ)

**Markets:** Financial, Trade Show

**Uses:** Events, Display, Occasions

*Ideal for a wide variety of events and occasions. Custom sizes also available.*

**Material:** Stretch Polyester

**Usage:** Indoors / Short-term Outdoors

**Production time:** 7-10 business days

**Finish:** Fully hemmed on all sides

**Made in USA:** Yes

**Prop 65 WARNING:** Cancer and/or Reproductive Harm. [www.P65Warnings.ca.gov](http://www.P65Warnings.ca.gov) ( zipper only / item DTCSZ)

Stretch Style		Item	Size	Finish	1	3	6	12	25
DTCS-4 / DTCSOB-4 / DTCSZ-4		4'	Full / Open / Zipper		245.00	178.60	143.85	105.60	90.10
DTCS-6 / DTCSOB-6 / DTCSZ-6		6'	Full / Open / Zipper		255.00	230.00	200.50	175.00	125.00
DTCS-8 / DTCSOB-8 / DTCSZ-8		8'	Full / Open / Zipper		275.00	250.00	220.00	190.00	135.00

R

## Table Top Banners



Table Top Banner Kit



Sign Up Table Kit



Table Cover Full Wall Kit

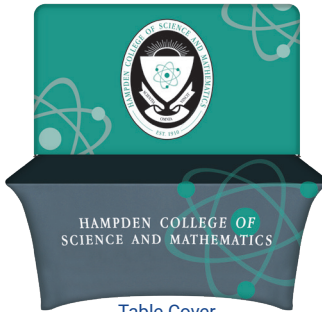

Table Cover Half Wall Kit



Table Top Replacement Banner Only

**Markets:** Trade Shows, POP, Education, Organizations, Safety

**Uses:** Seminars, Advertising, Branding

*Sleek. Easy. Versatile. Lightweight. These aluminum tube-frame banners are a must for anyone in need of a professional looking backdrop that takes seconds to set up.*

**Material:** Stretch Polyester

**Usage:** Indoors

**Production time:** 7-10 business days

**Finish:** Sewn around the edges

**Made in USA:** Yes

**Prop 65 WARNING:** Cancer and/or Reproductive Harm. [www.P65Warnings.ca.gov](http://www.P65Warnings.ca.gov)



Table Top Replacement Banner Only						
Item	Size	1	3	6	12	25
TTVB-2006T1R	6' / Small	104.41	87.02	76.78	70.55	49.25
TTVB-2008T1R	8' / Small	120.47	100.41	81.41	61.47	54.52
TTVB-2006T2R	6' / Medium	210.81	155.03	107.57	99.44	86.07
TTVB-2008T2R	8' / Medium	232.28	188.31	142.20	122.27	109.73
TTVB-2006T3R	6' / Large	248.56	201.51	152.17	130.84	117.42
TTVB-2008T3R	8' / Large	375.21	229.70	203.71	183.79	171.16

R

Table Top Banner Kit with Hardware						
Item	Size	1	3	6	12	25
TTVB-2006T1K	6' / Small	247.84	200.92	196.33	130.46	117.08
TTVB-2008T1K	8' / Small	261.23	211.78	159.93	137.50	123.40
TTVB-2006T2K	6' / Medium	296.93	272.82	190.46	177.14	153.52
TTVB-2008T2K	8' / Medium	346.84	240.66	213.42	192.55	177.35
TTVB-2006T3K	6' / Large	361.20	250.63	222.26	200.53	184.69
TTVB-2008T3K	8' / Large	416.71	328.16	282.15	253.21	239.99

R

Sign-Up Table Kit ( Stretch Polyester Table Cover Included)						
Item	Size	1	3	6	12	25
SUT-6K	6'	502.84	430.92	396.83	305.46	242.08
SUT-8K	8'	536.23	461.78	379.93	327.50	258.40

R

Table Cover Half Wall Kit ( Stretch Polyester Table Cover Included)						
Item	Size	1	3	6	12	25
TCHW-6K	6'	551.93	502.82	390.96	352.14	278.52
TCHW-8K	8'	621.84	490.66	433.42	382.55	312.35

R

Table Cover Full Wall Kit ( Stretch Polyester Table Cover Included)						
Item	Size	1	3	6	12	25
TCFW-6K	6'	616.20	480.63	422.76	375.53	309.69
TCFW-8K	8'	747.94	578.16	502.15	443.21	374.99

R

\*Hardware Imported





## Portable Banners and Kits

***Get maximum brand exposure and messaging  
at any location or event!***

**When determining which Portable Banner best suits your client's needs...**

**Where will it be used?** – Environmental conditions and possible vandalism dramatically impact longevity. Outdoor displays should be brought in during severe weather conditions and never left displayed overnight.

**How will it be used/displayed?** – If displayed on a hard surface, a cross base will be necessary. If going into the ground, a ground spike can be used. We have easy to use options for any use.

**How should messaging be presented?** – A single reverse message reads correctly on one side with the mirror image on back. Double-sided reads correctly on both sides but cost is higher.

**What size?** – The larger the size, the greater the impact but also the cost. Indoor, make sure full display is not taller than ceiling height.



# Portable Half Drop and Teardrop Banner Kits



**Markets:** Sports, Schools, Real Estate, Trade Shows, Businesses, Restaurants

**Uses:** Events, Conferences, Seminars, Fairs, Festivals, Roadside Display, Indoor Display, Branding, Advertising

*Give your brand or your next outdoor event the exposure it needs with our eye-catching Portable Banners!*

**Material:** Knit Polyester  
**Usage:** Outdoors / Indoors  
**Production time:** 7-10 business days  
**Finish:** Black nylon pole sleeve  
**Made in USA:** Yes  
**Prop 65 WARNING:**  
 Cancer and/or Reproductive Harm.  
[www.P65Warnings.ca.gov](http://www.P65Warnings.ca.gov)



Teardrop

Half Drop

- Attention Grabber
- Portable and Lightweight
- Easy 5 Minute Assembly
- Indoor and Outdoor Use

Single Reverse reads correct on one side and reversed on the backside. Double Sided reads correct on both sides and has a block-out liner in the center.

For surfaces where a spike can be inserted into the ground only.

Kits with Banner, Hardware with Ground Spike and Carrying Case							
Item	Size	Sides	1	3	6	12	25
PTB-6K / PHB-6K	6'	Single Reverse	177.95	165.45	152.95	125.45	103.70
PTB-8K / PHB-8K	8'	Single Reverse	192.95	179.85	166.70	136.70	112.45
PTB-10K / PHB-10K	10'	Single Reverse	210.45	201.70	192.95	166.10	138.10
PTB-12K / PHB-12K	12'	Single Reverse	222.95	217.95	212.95	178.45	150.45
PTB-15K / PHB-15K	15'	Single Reverse	253.45	245.35	237.20	198.70	166.20
PTB-D6K / PHB-D6K	6'	Double Sided	243.60	223.25	202.95	174.85	150.60
PTB-D8K / PHB-D8K	8'	Double Sided	268.60	251.40	234.20	202.00	173.70

R

For surfaces where a spike can be inserted into the ground or hard surface for the cross base.

Kits with Banner, Hardware with Ground Spike, Cross Base and Carrying Case							
Item	Size	Sides	1	3	6	12	25
PTB-6KC / PHB-6KC	6'	Single Reverse	206.05	193.55	181.05	151.05	125.55
PTB-8KC / PHB-8KC	8'	Single Reverse	221.05	207.95	194.80	162.30	134.30
PTB-10KC / PHB-10KC	10'	Single Reverse	238.55	229.80	221.05	191.70	159.95
PTB-12KC / PHB-12KC	12'	Single Reverse	251.05	246.05	241.05	204.05	172.30
PTB-15KC / PHB-15KC	15'	Single Reverse	281.55	273.45	265.30	224.30	188.05
PTB-D6KC / PHB-D6KC	6'	Double Sided	271.70	251.35	231.05	200.45	172.45
PTB-D8KC / PHB-D8KC	8'	Double Sided	296.70	279.50	262.30	227.60	195.55

R

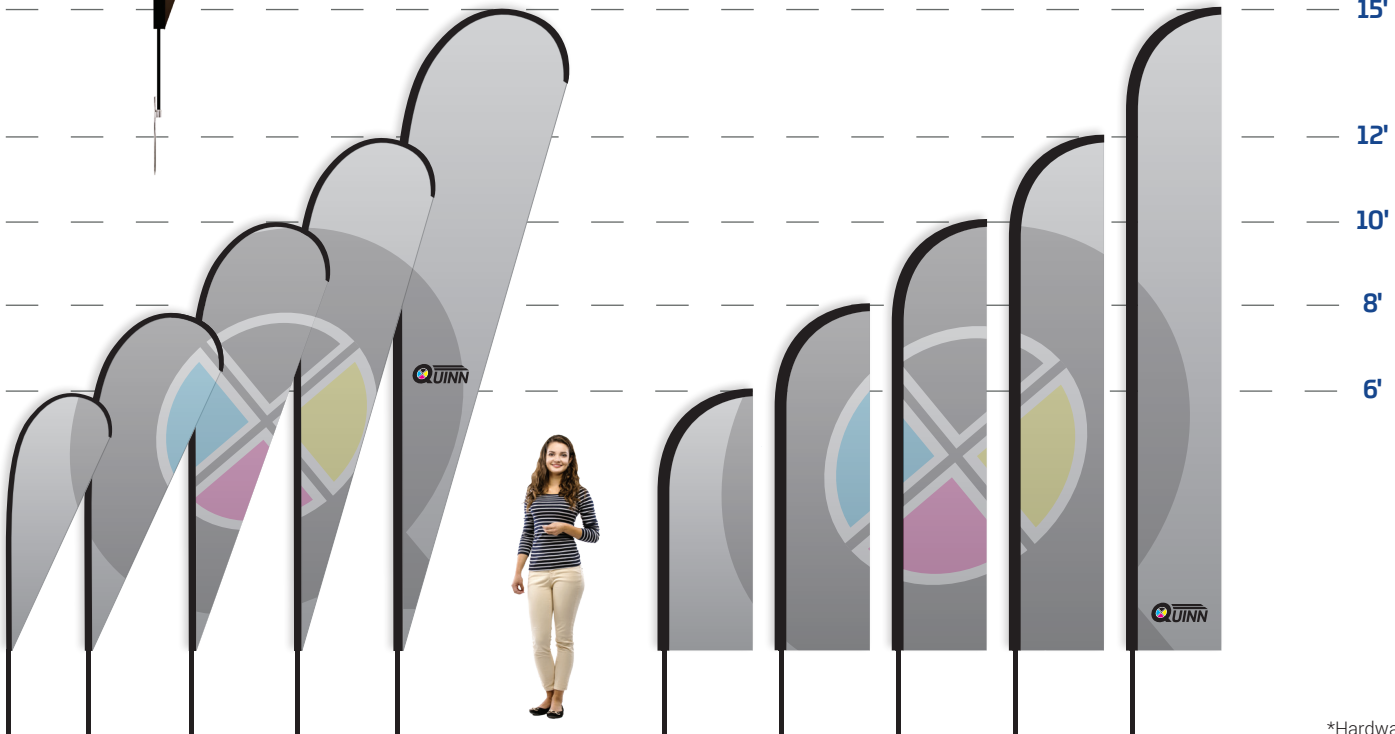

\*Hardware Imported

## Replacement Portable Half Drop and Teardrop Banners

Material: Knit Polyester  
 Usage: Outdoors  
 Production time: 7-10 business days  
 Finish: Black nylon pole sleeve  
 Made in USA: Yes  
 Prop 65 WARNING: Cancer and/or Reproductive Harm. www.P65Warnings.ca.gov



Single Reverse reads correct on one side and reversed on the backside. Double Sided reads correct on both sides and has a block-out liner in the center.

Single Reverse Banners						
Item	Size	1	3	6	12	25
PTB-6 / PHB-6	6'	115.60	103.10	90.60	65.60	46.85
PTB-8 / PHB-8	8'	124.35	111.25	98.10	70.60	49.35
PTB-10 / PHB-10	10'	135.60	126.85	118.10	93.75	68.75
PTB-12 / PHB-12	12'	140.60	135.60	130.60	98.60	73.60
PTB-15 / PHB-15	15'	162.35	154.25	146.10	110.10	80.60

Double Sided Banners						
Item	Size	1	3	6	12	25
PTB-D6 / PHB-D6	6'	181.25	160.90	140.60	115.00	93.75
PTB-D8 / PHB-D8	8'	200.00	182.80	165.60	135.90	110.60
PTB-D10 / PHB-D10	10'	218.10	207.80	197.50	159.35	130.00
PTB-D12 / PHB-D12	12'	262.50	243.75	225.00	194.35	158.40
PTB-D15 / PHB-D15	15'	290.60	271.80	253.00	224.85	190.60

### Hardware for Portable Banners

Hardware includes a sectional aluminum and fiberglass pole, ground spike and carrying bag.

Item	Size	1	12	25
PTH-6H / PTH-6T	6'	62.35	59.85	56.85
PTH-8H / PTH-8T	8'	68.60	66.10	63.10
PTH-10H / PTH-10T	10'	74.85	72.35	69.35
PTH-12H / PTH-12T	12'	82.35	79.85	76.85
PTH-15H / PTH-15T	15'	91.10	88.60	85.60

## Additional Portable Options for Half Drop & Teardrop Banners

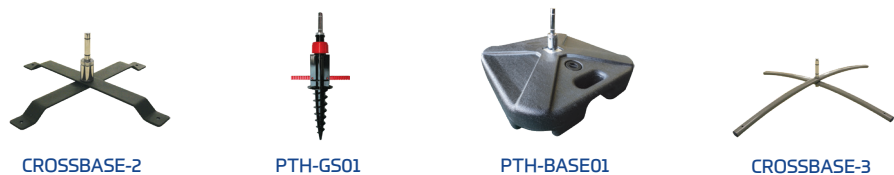

### Premium Banner Kits

Material: Knit Polyester  
 Usage: Outdoors  
 Production time: 7-10 business days  
 Finish: Black nylon pole sleeve  
 Made in USA: Yes  
 Prop 65 WARNING: Cancer and/or Reproductive Harm. www.P65Warnings.ca.gov



For surfaces where a spike can be inserted into the ground only.

Kits with Banner, Premium Hardware and Ground Spike							
Item	Size	Sides	1	3	6	12	25
PTB-D10P / PHB-D10P	10'	Double Sided	342.60	332.30	311.30	263.80	228.65
PTB-D12P / PHB-D12P	12'	Double Sided	387.00	368.25	338.80	298.80	257.05
PTB-D15P / PHB-D15P	15'	Double Sided	415.10	396.30	366.80	329.30	289.25

For surfaces where a spike can be inserted into the ground or hard surface for the cross base.

Kits with Banner, Premium Hardware and Cross Base with Removable Ground Spike							
Item	Size	Sides	1	3	6	12	25
PTB-D10PC / PHB-D10PC	10'	Double Sided	375.60	365.30	338.95	292.20	251.65
PTB-D12PC / PHB-D12PC	12'	Double Sided	420.00	401.25	366.45	327.20	280.05
PTB-D15PC / PHB-D15PC	15'	Double Sided	448.10	429.30	394.45	357.70	312.25



\*Hardware Imported





TOP SELLER!



- Stationary & Sets up in Minutes
- Economical Alternative to our Feather Flag

Material: Knit Polyester  
 Usage: Outdoors  
 Production time: 7-10 business days  
 Finish: Black nylon pole sleeve  
 Made in USA: Yes  
 Prop 65 WARNING: Cancer and/or Reproductive Harm. www.P65Warnings.ca.gov

Kit includes a 12' digitally printed custom Swooper Banner with a 15' Swooper Pole.



Swooper Banner with Hardware			
Item	1	12	24
SWOOP-C12K	112.40	107.00	100.30

Banner Only			
Item	1	12	25
SWOOP-C12	49.50	47.50	44.10

Swooper Banners Hardware

Necessary hardware is sold separately and includes 3 aluminum pole pieces that fit together and a ground spike.

Hardware Kits				
Item	Product	1	12	25
SWOOP-15FS	Hardware	62.90	59.50	56.20

Windsocks

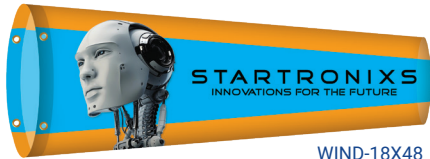

WIND-18X48



WIND-36X120



WIND-18X60



WIND-10X36

Markets: Safety, Aviation, Organizations

Uses: Branding, Airports, Highways, Seaports

Let your customers get wind of your brand with a custom imprinted windsock! This cool outdoor accessory is made using printed knit polyester for a high flying promotional display that you can count on.

Material: Knit Polyester  
 Usage: Outdoors  
 Production time: 10 business days  
 Finish: Reinforced grommets around the large opening  
 Made in USA: Yes

Item	Size	1	3	12	25	50+
WIND-6X24	6" x 24"	145.00	92.50	28.75	18.25	12.70
WIND-8X36	8" x 36"	150.32	96.50	34.75	24.95	17.50
WIND-10X36	10" x 36"	151.90	97.50	39.50	28.10	19.25
WIND-18X48	18" x 48"	178.00	119.50	56.50	37.95	29.75
WIND-18X60	18" x 60"	185.00	126.50	60.25	44.75	35.90
WIND-18X72	18" x 72"	210.00	182.50	67.10	48.40	38.90
WIND-18X96	18" x 96"	225.00	210.50	74.60	58.30	49.30
WIND-24X72	24" x 72"	225.00	210.50	74.60	58.30	49.40
WIND-24X96	24" x 96"	240.00	219.50	95.10	78.60	70.40
WIND-36X120	36" x 120"	350.00	298.50	156.50	135.90	114.10

R

\*Hardware Imported

## Feather Flags



Square  
Style: S

### 3 Different Cuts. All Same Price!

One Cut Per Design



Flutter  
Style: L



Feather  
Style: E

Our unique shape and tall design Feather Flags are sure to grab attention. Three different eye-catching cuts all at the same price!

Material: Knit Polyester  
Usage: Outdoors  
Production time: 7-10 business days  
Finish: Fabric pole sleeve with a sewn in loop at bottom of pole sleeve  
Made in USA: Yes  
Prop 65 WARNING: Cancer and/or Reproductive Harm. www.P65Warnings.ca.gov



Insert the style of your desired cut in place of the underscore in the item number. See style designations below.

Single Reverse reads correct on one side and reversed on the backside. See website for double sided options.

Single Reverse Flags						
Item	Size	1	6	12	25	50
FFK_--38	3' x 8'	114.00	68.00	54.50	46.50	34.10
FFK_--310	3' x 10'	134.00	79.50	62.50	52.50	36.90
FFK_--312	3' x 12'	144.00	89.00	69.50	56.50	42.90
FFK_--315	3' x 15'	159.50	99.50	79.50	64.50	48.10



## Hardware for Feather Flags

Portable Options for 15' and 21' Feather Flags

This 24.75" aluminum ground spike is designed for ease and portability for any feather flag shape. HW-SPIKE is needed with double sided feather flag 10' or larger. The premium ground spike provides a portable in-ground option.

Item	1	6	12	25
HW-SPIKE	38.90	33.75	28.50	26.10



Recommended using with a double sided Feather Flag 10' or larger, our premium cross base comes with a removable ground spike that is 7" long for a sturdy mount for your banner.

Item	1	6	12	25
HW-CROSSBASE	71.90	61.40	56.90	49.10



Telescoping Feather Flagpoles

Item	Size	Fits Flag Sizes	1	6	12	25
HW15FTELPO	15'	8' / 10' / 12' feather flags	62.45	58.15	55.00	53.15
HW21FTELPO	21'	All 15' feather flags	74.40	71.90	68.75	65.00

R

\*Hardware Imported



## Windchaser Flag Kits

- Stationary
- Flag Rotates in the Wind
- Message is Always Visible
- Available in 3 Popular sizes



**Markets:** Sports, Schools, Real Estate, Trade Shows, Businesses, Restaurants

**Uses:** Events, Fairs, Festivals, Roadside Display

*Windchaser Flags fly like a flag, yet stay open like a sign to keep your message always visible.*

Material: Knit Polyester

Usage: Outdoors

Production time: 7-10 business days

Finish: Pole sleeve across top & left side

Made in USA: Yes

Prop 65 WARNING: Cancer and/or

Reproductive Harm. www.P65Warnings.ca.gov



Single Reverse reads correct on one side and reversed on the backside. Double Sided reads correct on both sides and has a block-out liner in the center.

Kits with Single Reverse Flag and Hardware						
Item	Size	1	3	6	12	25
WC-8K	5'	173.65	130.25	112.60	94.00	77.65
WC-9K	8'	199.90	147.50	124.75	108.50	90.00
WC-13K	12'	233.65	182.50	149.50	133.00	112.25

Kits with Double Sided Flag and Hardware						
Item	Size	1	3	6	12	25
WC-D8K	5'	238.15	174.25	145.90	122.00	98.65
WC-D9K	8'	282.40	211.00	164.75	140.30	116.50
WC-D13K	12'	327.15	257.25	203.75	169.25	145.65



## Windchaser Flags

Single Reverse reads correct on one side and reversed on the backside. Double Sided reads correct on both sides and has a block-out liner in the center.

Single Reverse Flags						
Item	Size	1	3	6	12	25
WC-8	5'	120.00	78.50	61.70	46.50	35.00
WC-9	8'	132.50	81.50	64.50	51.00	38.00
WC-13	12'	152.50	102.75	72.50	58.75	43.50

Double Sided Flags						
Item	Size	1	3	6	12	25
WC-D8	5'	184.50	122.00	95.00	74.50	56.00
WC-D9	8'	215.00	145.00	101.50	79.80	61.50
WC-D13	12'	246.00	177.50	126.75	95.00	76.90

## Hardware for Windchaser Flags

Necessary hardware is sold separately and includes a 1" diameter aluminum pole with a ground spike and an aluminum arm with stopper.

Item	Size	1	2	5	11	16
WC-8-HW	5'	53.65	52.25	50.90	47.50	45.40
WC-9-HW	8'	67.40	66.00	63.25	60.50	57.75
WC-13-HW	12'	81.15	79.75	77.00	74.25	71.50

\*Hardware Imported



## Tents

### **Grab attention at any event or location with highly customizable branding!**

#### **When determining which Tents best suits your client's needs...**

**Where will it be used?** – Perfect for trade shows, tailgating, festivals, fairs and a variety of additional events, tents provide a durable, eye-catching solution for branding.

**How will it be used/displayed?** – With the option of spikes or weights to secure your tent, as well as a wheeled carry case for easy travel and set-up, tents can be displayed both indoor and outdoor.

**How should messaging be presented?** – Full color printing on the tent canopy provides optimal messaging, but additional accessories ranging from mountable banners, full walls and half walls, all of which have single reverse or double-sided options, allow for greater customization and branding impact.

**What size?** – Tents have a standard size of 10x10'. Contact us for pricing on additional customizations.





**Markets:** Trade Shows, Businesses, Food & Beverage, Sports

**Uses:** Events, Festivals, Fairs, Tailgating, Branding

*Top Quality Branding at Great Prices!*

**Material:** 600D Polyester / **Tent Frame:** Durable Aluminum Frame with Snap Lock Height Adjustments

**Usage:** Outdoors / Indoors

**Production time:** 7-10 business days

**Finish:** Sewn around all the edges to fit aluminum frame

**Made in USA:** No

**Prop 65 WARNING:** Cancer and/or Reproductive Harm. [www.P65Warnings.ca.gov](http://www.P65Warnings.ca.gov)

Art can be digitally printed on the inside or outside of full & half walls. Double Sided walls available for additional cost. Contact us for details.

10' x 10'						
Item	Walls	1	3	6	12	25
CPT-1010	None	939.97	674.05	621.50	589.64	557.92
CPT-3002T1K	1 Full	1137.33	868.67	781.88	711.71	665.63
CPT-3004T1K	2 Full	1760.03	1379.94	1240.55	1182.89	1124.18



**Tent frame, carrying case with wheels, spikes & rope are all included with every tent!**

**Why buy this 10' Canopy Tent from QUINN?**



QUINN offers full color digital printing on all valances & peaks with no additional charges.

One price regardless of art.

**NO HIDDEN FEES!**



Tents

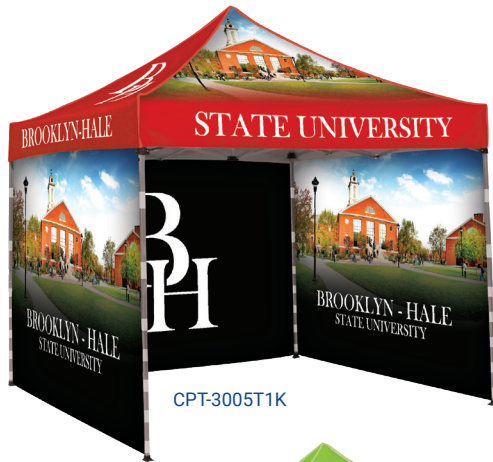

CPT-3005T1K



CPT-3001T2K



CPT-3003T1K

10' x 10'						
Item	Walls	1	3	6	12	25
CPT-3003T1K	1 Full, 2 Half	1361.57	1036.77	959.87	926.82	863.74
CPT-3005T1K	3 Full	2080.75	1656.43	1556.68	1457.07	1411.15

R

10' x 20'						
Item	Walls	1	3	6	12	25
CPT-3001T2K	None	1717.60	1474.42	1385.96	1266.51	1215.06

R

STAND OUT With Accessories!



CPT-2000T2TR



CPT-2000T2HR



Tent Banners

Add an eye-catching Half Drop or Teardrop Tent Banner! Made from a durable polyester and can be customized with a full-color digital imprint of your company name and logo for maximum brand exposure. Hardware available with purchase of a kit. Double sided banners are also available.

Tent Weights

Keep your tent grounded and safe when displaying on a hard surface and cannot use ground spikes.



CPT-5001T2



Visit [WWW.QUINNFLAGS.COM](http://WWW.QUINNFLAGS.COM) for Pricing & Additional Options!





## Advertising Banners, Wraps & Covers

***Spread the word about your company with products custom-made for advertising needs!***

**When determining which Portable Banner best suits your client's needs...**

**Where will it be used?** – Excellent for storefronts, corporate events or speeches, advertising banners cater to a diverse variety of uses, some specifically indoors and others specifically outdoors. Contact us for recommendations on what product would work best for your client's needs.

**How will it be used/displayed?** – While some products can be flown as outdoor promotional displays with reinforced grommets, others can be presented inside with a dowel and hanging cord. The use is specific to each product within the advertising banners, wraps & covers line.

**How should messaging be presented?** – Full color digital printing allows messaging to be printed on different products, with many having the capability to feature printing on both sides.

**What size?** – Containing a variety of sizes and cuts, advertising banners, wraps & covers offer adaptability for your client's needs. Contact us for more information on the specific products you'd like to know more about.



## Vinyl Avenue Banners



Use for  
**TOWN EVENTS**  
**PARKING LOTS**  
**MUNICIPAL LIGHT POLES**



FMSS  
Hardware

**Markets:** Municipal, Shopping Malls, Auto Dealerships

**Uses:** Advertising, Branding, Decorating, Event Messaging

*Have customers see your brand at every corner with this practical promotion! All Banners are Double Sided!*

**Material:** 28 oz. Vinyl

**Usage:** Outdoors

**Production time:** 7-10 business days

**Finish:** Pole sleeve on the top & bottom with 1 grommet top & bottom

**Made in USA:** Yes / No

**Prop 65 WARNING:** Cancer and/or

Reproductive Harm. [www.P65Warnings.ca.gov](http://www.P65Warnings.ca.gov)

Item	Size	1	3	6	12	25
VAB-3618	36" x 18"	136.90	94.00	69.30	53.55	41.30
VAB-5424	54" x 24"	161.90	114.70	98.05	77.20	55.15
VAB-6030	60" x 30"	208.00	133.55	112.80	91.45	70.50
VAB-7230	72" x 30"	248.00	157.20	126.00	96.80	78.65
VAB-9630	96" x 30"	292.00	196.05	156.90	114.40	98.65

## Hardware for Avenue Banners

Item	Length	1	6	12	25	50
FMSS-18	18"	77.50	72.50	70.00	67.50	65.00
FMSS-24	24"	80.00	75.00	72.50	70.00	67.50
FMSS-30	30"	85.00	80.00	77.50	75.00	72.50
FMSS-36	36"	87.50	85.00	82.50	80.00	77.50

Premium Spring Loaded Hardware also available. Please contact us for details.



## Sunbrella™ Avenue Banners

**Markets:** Outdoors, Shopping Malls, Auto Dealerships, Schools

**Uses:** Parking Lots, College Stadiums, Sports Arenas, Town Light Poles

*For those who only want high-end long-lasting Avenue and Light Pole Banners, Sunbrella™ material is the best in the industry. Used primarily for 1 and 2-spot color artwork. Best designs are simple so passersby can read and clearly see the brand/message.*

**Material:** Sunbrella™

**Usage:** Outdoors

**Production time:** 12-15 business days

**Finish:** 3" fold-over pole sleeves at top and bottom / 1 grommet top and bottom below and above pole sleeve

**Made in USA:** Yes

**Prop 65 WARNING:** Cancer and/or

Reproductive Harm. [www.P65Warnings.ca.gov](http://www.P65Warnings.ca.gov)

Artwork must be seen to quote. For artwork with gradients and full digital color, please see our vinyl avenue banners. Sunbrellas™ are screen printed from a selection of available colors. Visit our website for more info.

Item	Number of colors	Size	2	3	6	12
CSAB-3818-1	1 color print	38" x 18"	299.53	216.45	128.55	98.59
CSAB-3818-2	2 color print	38" x 18"	529.87	366.89	204.03	141.13
CSAB-3818-3	3 color print	38" x 18"	745.37	507.72	357.58	188.64
CSAB-5423-1	1 color print	54" x 22"	379.72	280.66	178.24	139.88
CSAB-5423-2	2 color print	54" x 22"	613.99	436.86	263.36	191.95
CSAB-5423-3	3 color print	54" x 22"	971.70	672.96	395.06	267.42

Item	Number of colors	Size	2	3	6	12
CSAB-6030-1	1 color print	60" x 30"	421.38	318.14	207.81	167.92
CSAB-6030-2	2 color print	60" x 30"	746.86	536.70	331.27	242.32
CSAB-6030-3	3 color print	38" x 18"	1067.61	752.11	457.81	318.21
CSAB-7223-1	1 color print	72" x 22"	426.89	322.86	211.67	171.64
CSAB-7223-2	2 color print	72" x 22"	843.55	596.45	375.77	273.07
CSAB-7223-3	3 color print	72" x 22"	1079.40	745.90	462.44	321.19
CSAB-7230-1	1 color print	72" x 30"	476.42	353.64	235.86	189.97
CSAB-7230-2	2 color print	72" x 30"	843.55	596.45	375.77	273.07
CSAB-7230-3	3 color print	72" x 30"	1207.55	835.40	517.99	364.15
CSAB-9630-1	1 color print	96" x 30"	596.70	446.23	301.45	250.24
CSAB-9630-2	2 color print	96" x 30"	1049.53	746.67	475.56	358.09
CSAB-9630-3	3 color print	96" x 30"	1462.96	1041.67	643.18	465.91



# Advertising Banners

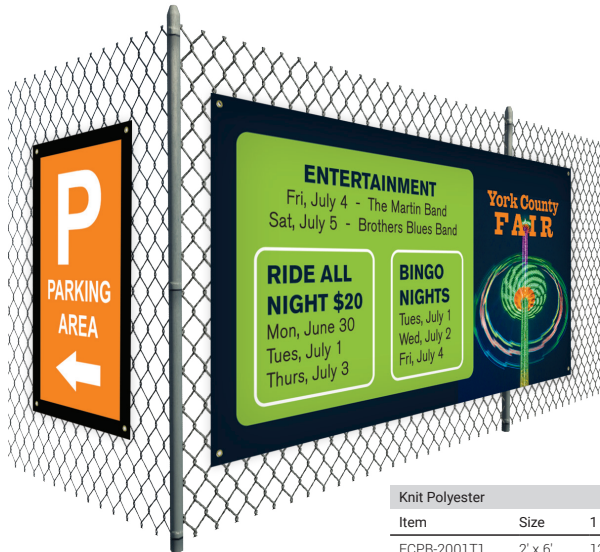

**Any Shape  
or Size!**

**Markets:** Sports, Schools, Retail, Construction, Safety, Businesses

**Uses:** Advertising, Branding, Event Messaging

Advertise your brand and message almost anywhere with eye-popping full color graphics! Vinyl banners are single sided and knit polyester banners are single reverse.

Material: 13 oz. Vinyl or 4 oz. Knit Polyester  
 Usage: Outdoor  
 Production time: 7-10 business days  
 Finish: 1 Grommet in each corner  
 Made in USA: Yes  
 Prop 65 WARNING: Cancer and/or Reproductive Harm. www.P65Warnings.ca.gov



Knit Polyester				
Item	Size	1	10	25
FCPB-2001T1	2' x 6'	124.35	49.75	43.55
FCPB-2002T1	3' x 6'	149.85	67.45	49.45
FCPB-2003T1	3' x 8'	164.85	79.15	57.70
FCPB-2004T1	3' x 15'	261.85	104.75	78.60
FCPB-2005T1	4' x 10'	249.35	99.75	74.85
FCPB-2006T1	4' x 20'	385.95	154.40	135.10

Vinyl						
Item	Size	1	3	5	10	25
VB-026	2' x 6'	148.00	103.65	74.40	65.95	49.00
VB-036	3' x 6'	172.00	113.25	93.00	77.20	53.65
VB-038	3' x 8'	180.00	128.45	108.20	88.25	63.35
VB-315	3' x 15'	288.00	214.65	157.55	115.55	89.30
VB-410	4' x 10'	260.00	199.45	142.40	111.15	83.35
VB-420	4' x 20'	398.85	312.75	220.00	176.00	144.75

R

R

# Giant Flagpole Kits



**Assembles  
in Minutes  
No Additional Tools  
Required**

**Markets:** Sports, Schools, Automotive, Businesses

**Uses:** Events, Festivals, Fairs, Tailgating, Advertising

Create a WOW moment with our Giant Flagpoles. No doubt you will be noticed!



Material: Knit Polyester  
 Usage: Outdoors  
 Production time: 7-10 business days  
 Finish: Sewn around all the edges to fit aluminum frame  
 Made in USA: Yes  
 Prop 65 WARNING: Cancer and/or Reproductive Harm. www.P65Warnings.ca.gov

Single Reverse reads correct on one side and reversed on the backside. Double Sided reads correct on both sides and has a block-out liner in the center.

Kit Including Hardware and Flag							
Item	Size	Sides	1	3	6	12	25
GFP-1001T2K	8'	Single Reverse	436.02	380.55	283.71	268.62	246.79
GFP-1001T2KD	8'	Double Sided	517.14	420.75	326.37	303.18	272.85
GFP-1002T2K	10'	Single Reverse	449.54	392.35	295.12	277.09	253.46
GFP-1002T2KD	10'	Double Sided	540.80	440.00	348.19	319.57	285.11
GFP-1003T2K	13'	Single Reverse	476.58	387.75	310.00	291.13	266.34
GFP-1003T2KD	13'	Double Sided	628.68	492.90	386.88	352.42	318.38

R

Hardware					
Item	1	3	6	12	25
GFP-1000T2	336.70	286.65	241.15	222.04	212.03

R

Replacement Flags							
Item	Size	Sides	1	3	6	25	
GFP-1001T2R	8'	Single Reverse	152.00	128.44	79.09	63.00	44.83
GFP-1001T2DR	8'	Double Sided	248.00	209.56	127.89	95.70	77.38
GFP-1002T2R	10'	Single Reverse	168.00	141.96	94.64	74.03	52.80
GFP-1002T2DR	10'	Double Sided	276.00	217.35	155.61	114.40	85.81
GFP-1003T2R	13'	Single Reverse	200.00	169.00	107.10	86.44	65.72
GFP-1003T2DR	13'	Double Sided	351.50	299.25	191.75	152.91	122.21

R

Podium Banners



Straight Cut

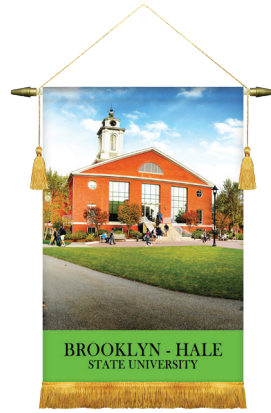

V Cut



Angle Cut

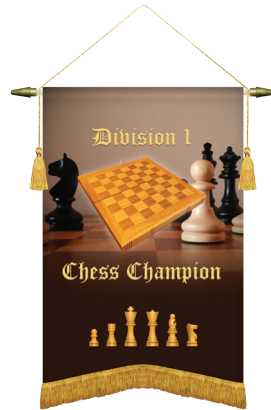

Many More Sizes & Shapes Available

**Markets:** Trade Shows, Schools, Municipal, Businesses, Financial, Political

**Uses:** Conferences, Banquets, Ceremonies, Awards, Motivational

*This banner will show off the very best of your brand with either a straight bottom or fringe!*

Material: Satin Polyester

Usage: Indoors

Production time: 7-10 business days

Finish: Sewn around all the edges

Made in USA: No

Prices listed below are for Banners with NO FRINGE. If interested in Fringe, please contact us for details.

Straight Cut					
Item	Size	6	12	25	50
DPPB-2230S	22" x 30"	64.90	46.20	26.90	18.55
DPPB-2648S	26" x 48"	65.20	47.60	29.25	23.10
DPPB-3054S	30" x 54"	80.95	60.00	35.30	27.95
DPPB-4260S	42" x 60"	103.35	66.95	56.25	39.80

R

Straight Cut / Giveaway Sizes					
Item	Size	12	25	50	100
DPPB-69S	6" x 9"	27.75	14.45	9.15	7.32
DPPB-710S	7" x 10"	28.10	14.65	9.20	7.36
DPPB-812S	8" x 12"	28.00	15.70	11.95	9.56
DPPB-1420S	14" x 20"	29.10	16.65	12.30	9.84

R

V Cut					
Item	Size	6	12	25	50
DPPB-2230V	22" x 30"	64.90	46.20	26.90	18.55
DPPB-2648V	26" x 48"	65.20	47.60	29.25	23.10
DPPB-3054V	30" x 54"	80.95	60.00	35.30	27.95
DPPB-4260V	42" x 60"	103.35	66.95	56.25	39.80

R

V Cut / Giveaway Sizes					
Item	Size	12	25	50	100
DPPB-69V	6" x 9"	27.75	14.45	9.15	7.32
DPPB-710V	7" x 10"	28.10	14.65	9.20	7.36
DPPB-812V	8" x 12"	28.00	15.70	11.95	9.56
DPPB-1420V	14" x 20"	29.10	16.65	12.30	9.84

R

Angle Cut					
Item	Size	6	12	25	50
DPPB-2230B	22" x 30"	64.90	46.20	26.90	18.55
DPPB-2648B	26" x 48"	65.20	47.60	29.25	23.10
DPPB-3054B	30" x 54"	80.95	60.00	35.30	27.95
DPPB-4260B	42" x 60"	103.35	66.95	56.25	39.80

R

Angle Cut / Giveaway Sizes					
Item	Size	12	25	50	100
DPPB-69B	6" x 9"	27.75	14.45	9.15	7.32
DPPB-710B	7" x 10"	28.10	14.65	9.20	7.36
DPPB-812B	8" x 12"	28.00	15.70	11.95	9.56
DPPB-1420B	14" x 20"	29.10	16.65	12.30	9.84

R

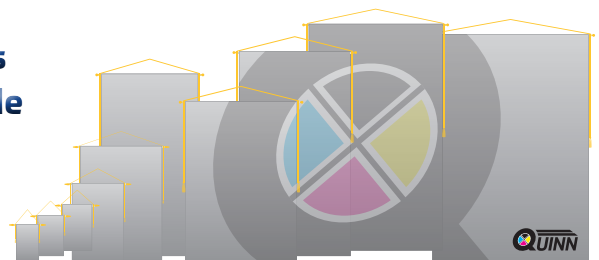



# Premium Podium Banners



Straight Cut



Material: Premium Satin  
 Usage: Indoors  
 Production time: 7-10 business days  
 Finish: Cut edges  
 Made in USA: No



Prices listed below are for Banners with NO FRINGE.  
 If interested in Fringe, please contact us for details.

Straight Cut						
Item	Size	1	3	6	12	25
DPPB-2230SP	22" x 30"	187.75	103.90	71.40	50.80	29.60
DPPB-2648SP	26" x 48"	198.00	104.35	71.70	52.35	32.20
DPPB-3054SP	30" x 54"	231.50	124.35	89.05	66.00	38.85
DPPB-4260SP	42" x 60"	270.70	163.70	113.70	73.65	61.85

R

Straight Cut / Giveaway Sizes						
Item	Size	3	6	12	25	50
DPPB-69SP	6" x 9"	69.30	50.90	30.55	15.90	10.10
DPPB-710SP	7" x 10"	74.25	51.80	30.90	16.60	10.60
DPPB-812SP	8" x 12"	80.20	51.65	30.80	17.25	13.15
DPPB-1420SP	14" x 20"	86.35	57.45	32.00	18.30	13.55

R



V Cut



V Cut						
Item	Size	1	3	6	12	25
DPPB-2230VP	22" x 30"	187.75	103.90	71.40	50.80	29.60
DPPB-2648VP	26" x 48"	198.00	104.35	71.70	52.35	32.20
DPPB-3054VP	30" x 54"	231.50	124.35	89.05	66.00	38.85
DPPB-4260VP	42" x 60"	270.70	163.70	113.70	73.65	61.85

R

V Cut / Giveaway Sizes						
Item	Size	3	6	12	25	50
DPPB-69VP	6" x 9"	69.30	50.90	30.55	15.90	10.10
DPPB-710VP	7" x 10"	74.25	51.80	30.90	16.60	10.60
DPPB-812VP	8" x 12"	80.20	51.65	30.80	17.25	13.15
DPPB-1420VP	14" x 20"	86.35	57.45	32.00	18.30	13.55

R

Angle Cut						
Item	Size	1	3	6	12	25
DPPB-2230BP	22" x 30"	187.75	103.90	71.40	50.80	29.60
DPPB-2648BP	26" x 48"	198.00	104.35	71.70	52.35	32.20
DPPB-3054BP	30" x 54"	231.50	124.35	89.05	66.00	38.85
DPPB-4260BP	42" x 60"	270.70	163.70	113.70	73.65	61.85

R

Angle Cut / Giveaway Sizes						
Item	Size	3	6	12	25	50
DPPB-69BP	6" x 9"	69.30	50.90	30.55	15.90	10.10
DPPB-710BP	7" x 10"	74.25	51.80	30.90	16.60	10.60
DPPB-812BP	8" x 12"	80.20	51.65	30.80	17.25	13.15
DPPB-1420BP	14" x 20"	86.35	57.45	32.00	18.30	13.55

R



Angle Cut



## Lustrous Heavyweight Satin Material

\*Hardware Imported

## Non-Woven Tote Bags



**Markets:** Trade Shows, Businesses, Grocery, Real Estate, Schools, Sports, Retail

**Uses:** Giveaways, Branding, Fundraising, Advertising

*These full color non-woven polypropylene bags are the perfect way to promote your brand.*

Material: Non-Woven Polypropylene  
 Usage: Indoors  
 Production time: 12 business days  
 Finish: Gloss or Matte  
 Made in USA: No  
 Prop 65 WARNING: Cancer and/or Reproductive Harm. www.P65Warnings.ca.gov

Item	Size	5000	10000	15000
NWBAG-1013	13.5" H x 3.5" W x 10.5" L	1.55	1.34	1.25

R

**Perfect size to fit tons of samples and literature!**

## Multi-Use Stretch Band Ideas



**Markets:** Trade Shows, Retail, Auto Dealerships, Schools, Businesses, Municipal, Political, Real Estate, Tourism

**Uses:** Giveaways, Events, Advertising, Branding

*Brand or add your message to any object with these unique stretch polyester bands. Multi-use stretch bands can be used to wrap just about any object with full color digital graphics.*

Material: Stretch Polyester  
 Usage: Outdoors / Indoors  
 Production time: 7-10 business days  
 Finish: Sewn edges  
 Made in USA: Yes



Item	1+
MUSB-4000	Call For Price

R

**Wrap growlers, mugs and kegs at the local brewery or wrap garbage cans, tanks and cylinders at events.**



## Marking and Utility Flags



**Plastic Staff,  
Fiberglass Staff &  
High Gloss Flags  
Also Available**

**Markets:** Construction, Organizations, Safety

**Uses:** Buried Cables, Construction Sites, Caution Areas

*These 1-color custom marking flags are an ideal way to flag down new business!*

Material: Vinyl  
Usage: Outdoors  
Production time: 7-10 business days  
Finish: Mounted to a wire staff  
Made in USA: Yes  
Prop 65 WARNING: Cancer and/or Reproductive Harm. [www.P65Warnings.ca.gov](http://www.P65Warnings.ca.gov)



Minimum order is 1,000 flags per case.  
2 Color also available. Call for more details.

Item	Flag size	Staff size	1	4	10	25
1500	2.5" x 3.5"	11.5"	192.15	173.25	157.50	140.90
1510	4" x 5"	15"	210.90	190.25	172.95	154.75
1515	4" x 5"	18"	217.00	195.75	177.90	159.25
1520	4" x 5"	21"	222.75	202.90	184.50	165.10
1525	4" x 5"	24"	228.90	206.50	187.75	168.00
1530	4" x 5"	30"	241.65	217.90	198.20	177.40
1535	4" x 5"	36"	255.25	230.50	209.10	187.00
1540	5" x 8"	30"	265.15	239.50	217.75	194.90
1545	5" x 8"	36"	276.00	248.95	226.40	202.60

### Imprint Options



### Background Flag Options



## Metal Desk Sets

**Markets:** Education, Organizations

**Uses:** Branding, Schools, Offices, Trade Shows

*These 11-19.7" metal telescopic flagpole banners are a simple metal desk accessory that provides a sophisticated look sure to gain maximum brand exposure. A simple and sleek design allows you to switch flags and banners easily at trade shows, fundraisers, corporate promotions and much more.*

Material: Polyester / Metal  
Usage: Indoors  
Production time: 10 business days  
Finish: Sewn around the edges  
Made in USA: Yes  
Prop 65 WARNING: Cancer and/or Reproductive Harm. [www.P65Warnings.ca.gov](http://www.P65Warnings.ca.gov)



Other shapes and styles are available on request.  
Minimum quantity of 12 per order.

Single Reverse / Telescopic Pole extends from 11" to 19.7"						
Item	Flag Size	12	25	50	100	250+
DSF29S	5.5" x 8"	43.50	35.10	25.80	20.70	17.80
DSF32S	8" x 12"	48.50	37.90	27.15	23.00	18.70
DSF28S	5.49" x 8.27"	47.50	36.90	26.65	23.00	18.70

Double Sided / Telescopic Pole extends from 11" to 19.7"						
Item	Flag Size	12	25	50	100	250+
DSF29D	5.5" x 8"	44.50	36.10	26.40	21.20	18.20
DSF32D	8" x 12"	49.50	38.90	27.75	23.50	19.10
DSF28D	5.49" x 8.27"	48.50	37.90	27.25	23.50	19.10

\*Hardware Imported

## Mini Teardrop Banners



PTBM-200LG  
(NEW SIZE)

PTBM-200

**Markets:** Trade Shows, Retail, Food & Beverage, Businesses, Financial, Healthcare

**Uses:** Office Cubicles, Retail Aisles, Warehouse Labeling

*There's nothing mini about the impression your brand will make with these Mini Teardrop Banners. Decorate your desktop, store or cubicle in style.*

**Material:** Knit Polyester  
**Usage:** Indoors  
**Production time:** 7-10 business days  
**Finish:** Black nylon pole sleeve  
**Made in USA:** Yes  
**Prop 65 WARNING:** Cancer and/or Reproductive Harm. [www.P65Warnings.ca.gov](http://www.P65Warnings.ca.gov)



### Clip

Hardware set includes a rod and plastic clip (opening to 1.5") that keeps the display steady. Flag size is 11" x 21". Total assembly height is 30".

Item	Sides	6	12	25	50	100
PTBM-400	Single Reverse	50.80	36.85	26.60	20.20	16.20
PTBM-400D	Double Sided	67.50	49.50	36.50	27.25	21.50

R

### Suction

Hardware set includes rod and a heavy duty suction cup. This product can be attached to multiple hard surfaces or the suction cup can be used as a tabletop base, providing a versatile product in a variety of settings. Flag size is 11" x 21". Total assembly height is 29".

Item	Sides	6	12	25	50	100
PTBM-110	Single Reverse	54.95	38.95	31.95	24.99	19.95
PTBM-110D	Double Sided	69.10	56.10	41.85	34.15	28.50

R

### Desktop

Hardware set includes a black carrying case, fiberglass rod and attractive weighted screw base that keeps display steady. Flag size is 9" x 14". Total assembly size is 11" x 18". New size banner is 12.25" x 24.5". Total assembly size is 15" x 29".

Item	Sides	6	12	25	50	100
PTBM-200	Single Reverse	43.80	29.90	25.50	18.40	13.35
PTBM-200D	Double Sided	52.50	36.00	30.00	24.50	16.25
PTBM-200LG	Single Reverse	50.60	39.75	29.95	23.00	16.65
PTBM-200DLG	Double Sided	58.80	42.00	34.65	27.55	19.00

R

Single Reverse reads correct on one side and reversed on the backside. Double Sided reads correct on both sides and has a block-out liner in the center.



Clip



Suction Cup



Desktop Base

\*Hardware Imported



# Show off your school spirit with banners, wearables and more!

When determining which School Spirit product best suits your client's needs...

**Where will it be used?** – Versatile as an ideal means of branding for giveaways, tailgating, conventions or sporting events, the school spirit line offers an assorted range of products catered to varying uses. Contact us for recommendations on what product would work best for your client's needs.

**How will it be used/displayed?** – Some products in the school spirit line can be displayed as wearables, some as stationary branding and some as banners that can be moved around. The use is specific to each product within the school spirit line.

**How should messaging be presented?** – Messaging can be printed through full-color imprinting on elastic wearables, on single reverse or double-sided banners or on polyester scarves. The way your messaging can be presented changes with every product in the school spirit line.

**What size?** – Ranging from pens with pull-out banners to massive stadium banners that can be used to promote your messaging on a field, products within the school spirit line come in a variety of sizes. Contact us for more information on the specific products you'd like to know more about.

Bandana

Stadium  
Scarves

Arm  
Sleeve

Arm  
Band

## School Spirit

**Markets:** Schools, Sports, Businesses

**Uses:** Events, Giveaways, Branding, Advertising, Tournaments, Fairs, Festivals

Show off your team spirit at your next event with a stadium scarf, bandana, arms sleeves or any of our other wearable products!

## Wearables

### Multifunctional Headwear

This multi-purpose wearable is a stylish accessory for showing off a favorite brand, sports team, company or awareness organization. It can be used as a face mask, neckerchief, bandana, wristband, hood, hair tie and more.

Material: Stretch Polyester  
 Usage: To be worn  
 Production time: 15 business days  
 Finish: Sewn around the edges  
 Made in USA: No

Item	100	250	500	1000	2500
MFH-919	5.50	4.60	3.85	3.20	2.73



### Premium Antimicrobial Multifunctional Headwear

Material: 4 direction stretch fabric with Anti Microbial treatment and UPF 50 coating  
 Usage: To be worn  
 Production time: 15 business days  
 Finish: Sewn around the edges  
 Made in USA: No

Item	100	250	500	1000	2500
MFHP-1014	8.05	6.65	4.55	3.85	1.54



### Bandanas

Create a lasting promotion for your business with these multi-purpose and reusable bandanas. Can be worn as a wristband, a head wrap, a neck warmer, a rally towel and so much more.

Material: Polyester Microfiber  
 Usage: To be worn  
 Production time: 15-17 business days  
 Finish: Sewn around the edges  
 Made in USA: No  
 Prop 65 WARNING: Cancer and/or Reproductive Harm. www.P65Warnings.ca.gov

Item	Size	250	500	1000	2500
BANDANA-22	22" x 22"	4.05	3.40	2.85	2.70



**NEW!**

### Stadium Scarves

Have your clients get in the spirit at trade shows, conventions, sporting events and much more!

Material: Polyester Satin  
 Usage: To be worn  
 Production time: 12-15 business days  
 Finish: Sewn around the edges  
 Made in USA: No  
 Prop 65 WARNING: Cancer and/or Reproductive Harm. www.P65Warnings.ca.gov

Item	Size	24	50	100	250	500
SSC-557	55" x 7"	16.45	15.35	11.75	9.60	9.15



### Arm Sleeves

This eye-catching item is ideal for sporting events either as a spectator or a player. Multiple sizes are available - please inquire for custom sizes.

Material: Stretch Polyester  
 Sold in sets of 2  
 Usage: To be worn  
 Production time: 12-15 business days  
 Finish: Sewn around the edges  
 Made in USA: No  
 Prop 65 WARNING: Cancer and/or Reproductive Harm. www.P65Warnings.ca.gov

Item	Size	Width	100	250	500	1000	2500
SAS-11P	11"	3.75" Top, 3" Bottom	6.67	5.91	3.98	3.49	2.95
SAS-15	15"	4.3" Top, 3.3" Bottom	7.42	6.38	4.36	3.82	3.30
SAS-15L	15"	6.5" Top, 5.5" Bottom	9.88	8.55	5.99	5.67	4.80



### Body Flags

Ideal for schools, athletic clubs and professional teams, this wow-worthy wearable is a great way to show pride.

Material: 100D Polyester  
 Usage: To be worn  
 Production time: 7-10 business days  
 Finish: Sewn around the edges  
 Made in USA: No

Item	Size	25	50	100	250	500
SBF-35	3' x 5'	37.00	29.20	24.45	20.65	16.90



### Arm Bands

Great for school spirit functions, sporting events, awareness programs and so much more.

Material: Polyester  
 Usage: To be worn  
 Production time: 15-17 business days  
 Finish: Closed with attached fastener  
 Made in USA: No  
 Prop 65 WARNING: Cancer and/or Reproductive Harm. www.P65Warnings.ca.gov

Item	Size	100	250	500	1000	2500
SARMB-13	13" x 3.7"	6.00	4.80	4.20	3.65	3.30





## Scroll Banners

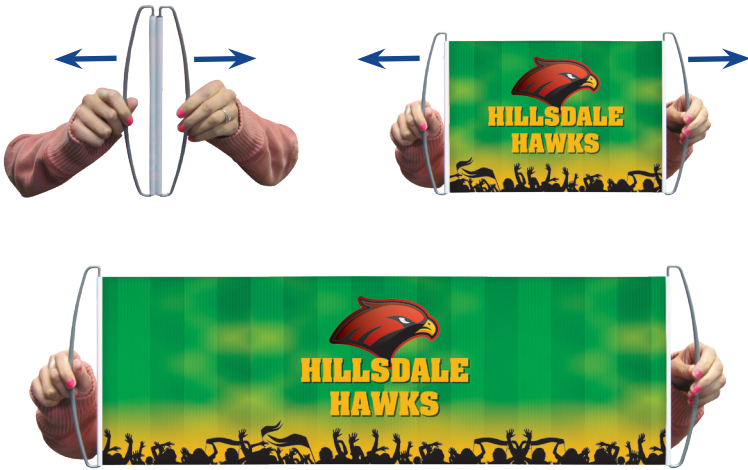

Don't scroll past this item! This is an eye-catching, affordable way to get your message across.

Material: Polyethylene  
 Usage: Outdoors / Indoors  
 Production time: 12-15 business days  
 Finish: Mounted to plastic handles  
 Made in USA: No  
 Prop 65 WARNING: Cancer and/or Reproductive Harm. www.P65Warnings.ca.gov

Item	Sides	250	500	1000	2500
SCROLLBANNER-1	Single Sided	8.70	5.75	3.45	2.20
SCROLLBANNER-2	Double Sided	11.55	6.75	4.00	2.45

Customizable with a 4-color process imprint. Please contact us for a quote if your design requires more than 4 colors.

Quiet · Safe · Compact · Affordable

## Fan Flags



Increase audience participation by passing these out at speeches, rallies, holiday parties and much more.

Material: Polyester  
 Usage: Outdoors / Indoors  
 Production time: 7-10 business days  
 Finish: Hemmed edges  
 Made in USA: No  
 Prop 65 WARNING: Cancer and/or Reproductive Harm. www.P65Warnings.ca.gov

Item	Size	25	50	100	250	500
DPSF-8121001	8" x 12"	9.98	7.35	4.90	3.55	2.75
DPSF-12181001	12" x 18"	13.25	7.95	6.80	4.75	3.60

Affordable and Long Lasting

## Premium Gonfalons

Premium Display Polyester Gonfalons are ceremonial banners hung from a crossbar, perfect for ceremonies, graduations, religious events, championships, and much more.

Material: Premium Display Polyester  
 Usage: Indoors  
 Production time: 7-10 business days  
 Finish: 3" pole sleeve with middle notch cut in back to fit hardware  
 Made in USA: Yes



Prices listed below are for Banners with NO FRINGE. If interested in Fringe, please contact us for details.

Premium 7' Gonfalon Kits						
Item	Size	Cut	1	3	6	12
GF-3048VK1	30" x 48"	V-Cut	409.15	310.45	275.05	251.50
GF-3048SK1	30" x 48"	Straight Cut	409.15	310.45	275.05	251.50
GF-3660VK1	36" x 60"	V-Cut	432.20	336.30	279.60	253.55
GF-3660SK1	36" x 60"	Straight Cut	432.20	336.30	279.60	253.55
GF-3672VK1	36" x 72"	V-Cut	469.10	358.80	293.60	263.65
GF-3672SK1	36" x 72"	Straight Cut	469.10	358.80	293.60	263.65

Fringe and 8' Gonfalon Kits also available.

NEW

## Breakaway Banners

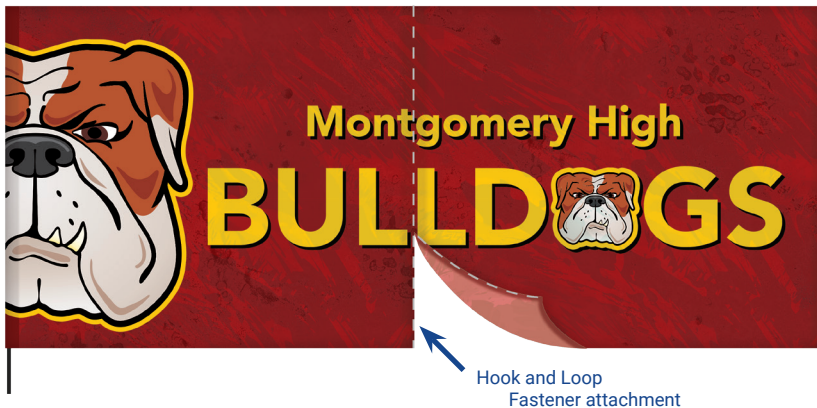

## Hook and Loop Fastener Offers Easy Break Away

Create a promotional display that's ideal for a variety of events and occasions.

**Material:** Knit Polyester  
**Usage:** Outdoor  
**Production time:** 7–10 business days  
**Finish:** Pole sleeve on left & right sewn closed at the top  
**Made in USA:** Yes

Item	Size	1	3
CBB-412	4' x 12'	264.95	186.20
CBB-512	5' x 12'	280.00	198.15

R

## School Spirit Flags



They'll feel the spirit as soon as they see this knit polyester school spirit flag parading across any field!

**Material:** Knit Polyester  
**Usage:** Outdoors  
**Production time:** 7–10 business days  
**Finish:** Pole sleeve to fit 1" diameter pole and sewn closed at the top  
**Made in USA:** Yes



Single Reverse reads correct on one side and reversed on the backside. Double Sided reads correct on both sides and has a block-out liner in the center.

Flags					
Item	Size	Sides	1	3	6
SSF-56-SR	5' x 6'	Single Reverse	249.40	173.45	149.40
SSF-56-DS	5' x 6'	Double Sided	349.40	243.15	218.15
SSF-68-SR	6' x 8'	Single Reverse	280.00	198.15	168.15
SSF-68-DS	6' x 8'	Double Sided	392.45	277.45	245.65

R

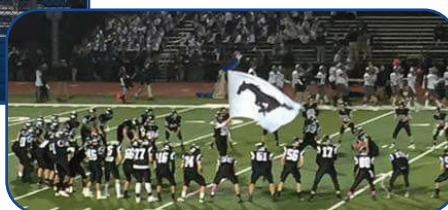

Hardware					
Item	Color	Size	1	12	24
ADP-800CS	Silver	8'	23.96	22.80	21.68

U

Hardware			
Item	Color	Size	1
ADP-1000CS	Silver	10'	35.50

U

\*Hardware Imported



## Felt Pennants



Go with the classic look of authentic felt pennants! Hang it around your dorm, your place of business or pass it out as a souvenir.

**Material:** Felt  
**Usage:** Indoors  
**Production time:** 7–10 business days  
**Finish:** Sewn on header  
**Made in USA:** No

Item	Size	Orientation	100	250	500	1000	2500
DFP-410	4" x 10"	Horizontal	5.00	3.10	2.00	1.40	0.98
DFP-512	5" x 12"	Horizontal	5.25	3.40	2.25	1.70	1.28
DFP-818	8" x 18"	Horizontal	5.95	4.60	3.50	2.63	2.12
DFP-924	9" x 24"	Horizontal	6.65	4.70	3.65	2.93	2.40
DFP-1230	12" x 30"	Horizontal	8.00	5.90	4.40	3.53	3.10
FTP-1420	14" x 20"	Vertical	9.45	6.65	5.00	4.00	3.20
FTP-2436	24" x 36"	Vertical	23.90	18.50	13.95	11.85	10.70
FTP-3048	30" x 48"	Vertical	37.15	28.00	23.80	20.25	18.25

R

## Wooden Dowels Available!

Contact us for details.

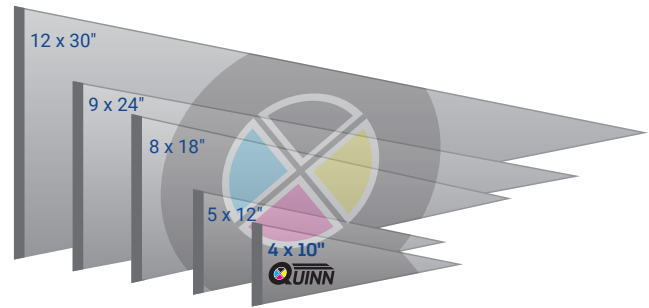

## Felt Banners



This Banner can be hung vertically or horizontally, creating a versatile product for an endless number of branding and advertising purposes. Any shape or size available. Please inquire.

**Material:** Felt  
**Usage:** Indoors  
**Production time:** 7–10 business days  
**Finish:** Heat cut edges with a pole sleeve  
**Made in USA:** No

Item	Size	100	250	500	1000	2500
FRB-1420	14" x 20"	11.75	8.80	7.00	5.25	4.45
FRB-2436	24" x 36"	23.30	18.65	14.95	12.75	11.50
FRB-3048	30" x 48"	38.50	28.90	24.60	21.60	19.00

R

# From spirit sales to delivery services and beyond, car flags are great for advertising a product, service or message!

## When determining which Car Flags & Auto Accessories best suits your client's needs...

**Where will it be used?** – Suitable for indoor and outdoor use, car flags are great for promotional opportunities that range from corporate branding, to delivery services, to awareness events and so forth.

**How will it be used/displayed?** – Certain car flags are designed for stationary use while others can be used at highway speeds. Let us know how the car flags will be used so we can recommend which will work best!

**How should messaging be presented?** – Offering both single-ply and double-sided imprinting. With a variety of shapes to choose from, several options are available for maximizing the impact of your branding or messaging.

**What size?** – Standard sizes are 7.5" x 10" and 11.5" x 15" for stationary or highway use, while additional half drop and teardrop options are available, with the capability of a variety of shapes for all.



## Auto Accessories

### Car Stretch Products

**Markets:** Auto Dealerships, Fundraisers, Schools, Delivery, Ride Share, Sports, Businesses

**Uses:** Advertising, Branding, Giveaways

*Put your message on something that's built for the road with these promotional items! Our automotive products are made from stretch polyester that slips easily over headrests, mirrors or fuel doors in cars, SUVs, trucks and more.*

**Material:** Stretch Polyester

**Usage:** Outdoors

**Production time:** 7–10 business days

**Finish:** Sewn around the edges

**Made in USA:** No

**Prop 65 WARNING:** Cancer and/or Reproductive Harm.

[www.P65Warnings.ca.gov](http://www.P65Warnings.ca.gov)



### Fuel Door Covers

An elastic band holds the cover and can be used with both round and square fuel doors. Cover will remain on while you drive.

Item	Fits fuel door sizes	100	200	300	400	500
CCGC-89	6.5 x 6.5" - 8.25 x 9.25"	6.55	4.60	3.75	3.35	3.05

### Headrest Covers

Sold in pairs, allowing you to completely outfit any vehicle.

Item	Size	100	200	300	400	500
CCHC-99	9" x 9.84"	10.45	8.30	6.60	5.99	5.25

### Mirror Covers

An elastic band holds it in place on the outside car mirrors of your vehicle. Intended for stationary and parade use only. Sold in pairs.

Item	Size	100	200	300	400	500
CCMC-SM	10.63" x 9.5"	8.50	6.60	6.00	5.10	4.70
CCMC-LG	11.81" x 9.5"	9.00	6.80	6.45	5.65	5.35



## Promotional Car Flags



Custom printed car flags are great for spirit sales, corporate branding, delivery services, auto dealerships, awareness events, college bookstores and more.

**Material:** Knit Polyester  
**Usage:** Outdoors  
**Production time:** 7-10 business days  
**Finish:** Mounted to Economy / Premium car flag staff  
**Made in USA:** No  
**Prop 65 WARNING:** Cancer and/or Reproductive Harm. [www.P65Warnings.ca.gov](http://www.P65Warnings.ca.gov)

Our car flags with a 15" Economy Flex Staff are great for those with a certain budget and is standard for stationary and parade use.

Economy Staff							
Item	Size	Sides	100	250	500	1000	2500
CCFP-75E	7.5" x 10.5"	Single Reverse	4.82	3.62	2.90	2.33	1.98
CCFP-115E	11.5" x 15"	Single Reverse	5.98	4.48	3.60	3.15	2.75

## Traditional Car Flags



**Material:** Knit Polyester  
**Usage:** Outdoors  
**Production time:** 7-10 business days  
**Finish:** Mounted to Economy / Premium car flag staff  
**Made in USA:** Yes  
**Prop 65 WARNING:** Cancer and/or Reproductive Harm. [www.P65Warnings.ca.gov](http://www.P65Warnings.ca.gov)

Our car flags with a 15" Economy Flex Staff are great for those with a certain budget and is standard for stationary and parade use.

Economy Staff							
Item	Size	Sides	6	12	25	50	100
CCFP-75S	7.5" x 10.5"	Single Reverse	24.35	20.00	15.60	10.25	7.20
CCFP-75D	7.5" x 10.5"	Double Sided	28.10	23.75	18.75	13.35	9.35

Our car flags with a Premium Staff are great for any use including standard highway speeds.

Premium Staff							
Item	Size	Sides	6	12	25	50	100
CCFP-75PS	7.5" x 10.5"	Single Reverse	29.50	24.25	18.75	10.95	7.70
CCFP-115S	11.5" x 15"	Single Reverse	38.35	31.50	24.40	13.75	9.65
CCFP-75PD	7.5" x 10.5"	Double Sided	33.75	28.50	22.50	14.75	10.35
CCFP-115D	11.5" x 15"	Double Sided	43.90	37.05	29.25	17.95	12.60

## Magnetic Car Flags



This magnetic car flag is an effective alternative to a traditional window style car flag.

**Material:** Knit Polyester  
**Usage:** Outdoors  
**Production time:** 7-10 business days  
**Finish:** Pole sleeve to fit hardware / mounted to staff with magnetic base  
**Made in USA:** Yes  
**Prop 65 WARNING:** Cancer and/or Reproductive Harm. [www.P65Warnings.ca.gov](http://www.P65Warnings.ca.gov)



Item	Size	Sides	6	12	25	50	100
WMMF-1001T2K	5.5" x 8.25"	Single Reverse	38.80	28.54	26.22	19.80	17.02
WMMF-1001T2KD	5.5" x 8.25"	Double Sided	43.60	32.07	29.46	20.57	19.13

\*Hardware Imported





## Pennant Strings

***Spice up your event and POP area with branding everywhere you look!***

**When determining which Pennant String best suits your client's needs...**

**Where will it be used?** – If being used outdoor in any weather condition and longer-term use, PVC is the best material but shorter use material options are available. Contact us for pricing.

**How will it be used/displayed?** – Knowing the space your pennant string will be displayed will help determine the length for each string and how many will be needed.

**How should messaging be presented?** – Multiple designs and messages and even die cut shapes on the same string are options but increase cost.

**What size?** – Almost any size pennant/rectangle/die cut is available. Standard size is 12" x 18". Contact us for pricing for any other size.



# Pennant Strings

**Markets:** Retail, Auto Dealerships, Restaurants, Shopping Malls

**Uses:** Events, Parades, Races, Parties, Picnics, Grand Openings, Advertising, Branding

*Pennant Strings are an outstanding way to decorate outdoor venues. Make a statement at your next event!*

**Material:** Polyethylene  
**Usage:** Outdoors / Indoors  
**Production time:** 15 business days  
**Finish:** Leads on each end  
**Made in USA:** No  
**Prop 65 WARNING:** Cancer and/or Reproductive Harm. [www.P65Warnings.ca.gov](http://www.P65Warnings.ca.gov)

Item	Length	Shape	12	25	50	100	250
PSPVC15T	15'	Triangle	155.00	96.50	56.20	31.90	17.50
PSPVC15R	15'	Rectangle	167.50	110.00	63.50	36.90	25.50
PSPVC30T	30'	Triangle	168.50	106.90	62.50	36.20	25.50
PSPVC30R	30'	Rectangle	189.50	120.00	76.50	42.90	36.10
PSPVC60T	60'	Triangle	186.00	104.50	72.90	43.50	34.90
PSPVC60R	60'	Rectangle	198.50	136.95	90.00	64.50	52.80
PSPVC100T	100'	Triangle	189.50	131.90	85.00	56.90	46.90
PSPVC100R	100'	Rectangle	228.50	156.00	116.50	83.50	72.20

Pricing is for one art file - please inquire for pricing if multiple files are needed.

## Any Shape and Length Available



## In-Stock 4 Mil Polyethylene Pennant Strings

*Head to the races with the right look! Simply hang them across the finish line or doorway of your next event and start your engines!*

**Material:** Polyethylene  
**Usage:** Outdoors / Indoors  
**Production time:** Stock item  
**Finish:** Leads on each end  
**Made in USA:** Yes  
**Prop 65 WARNING:** Cancer and/or Reproductive Harm. [www.P65Warnings.ca.gov](http://www.P65Warnings.ca.gov)



Multi-Color			
Item	Length	1	26
PS-30-A	30'	5.00	4.80
PS-60-A	60'	9.50	9.10
PS-100-A	100'	14.25	12.25



Red, White, and Blue			
Item	Length	1	26
PS-30-B	30'	5.00	4.80
PS-60-B	60'	9.50	9.10
PS-100-B	100'	14.25	12.25

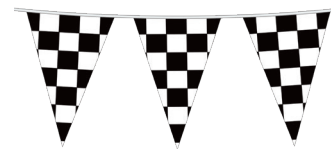

Black and White Checkered				
Item	Length	2	25	50
CTS-30	30'	9.50	7.85	7.30
CTS-60	60'	15.00	14.50	14.20
CTS-100	100'	24.50	23.20	22.95



## Display Products

**Wow them at your event and POP area with high impact branding & messaging!**

**When determining which Display Product best suits your client's needs...**

**Where will it be used?** – Will it be displayed indoor or outdoor? Is floor space limited?

**How will it be used/displayed?** – How do you want your branding and messaging to look? Is it easy to set up and breakdown? Is it heavy? How often will graphics change?

**How should messaging be presented?** – Will there be 2-way traffic? Design your branding and messaging for optimal impact based upon the shape of the display.

**What size?** – Are there height restrictions? What are you promoting? How do you want to present your brand, product or message? Displays come in many sizes each with specific benefits presenting your image.



## Backdrop Banners

**Markets:** Trade Shows, Retail, Schools, Sports, Businesses, Safety, Organizations, Financial, Healthcare

**Uses:** Branding, Advertising, Seminars, Conferences, Events

Add some high profile promotional display to any event or occasion with one of our backdrop banners.

**Material:** Premium Display Polyester

**Usage:** Indoors

**Production time:** 7–10 business days

**Finish:** Pole sleeve on top and bottom / 4 reinforced grommets on left and right side of banner.

**Made in USA:** Yes

**Prop 65 WARNING:** Cancer and/or

Reproductive Harm. [www.P65Warnings.ca.gov](http://www.P65Warnings.ca.gov)



- Easy Set Up
- Hardware Telescopes to a Maximum of 8' x 8' or 10' x 10'
- Includes Carrying Bag for Easy Transport

Item	Product	Size	1	3	6	12	24
BBSS-200	Banner & Hardware	8' x 8'	508.25	350.05	322.95	297.00	277.40
BBS-1	Hardware Only	Max. 8' x 8'	252.84	204.98	154.79	133.09	119.44
BBSB-200	Replacement Banner	8' x 8'	320.25	229.30	203.35	183.75	165.75
BBW-2001T2K	Banner & Hardware	10' x 10'	739.40	612.40	583.25	458.20	435.65
BBW-2001T2R	Replacement Banner	10' x 10'	552.00	401.20	371.40	256.95	226.00
BBW-2000T2	Hardware Only	Max. 10' x 10'	414.30	287.47	247.16	221.81	210.24



10' x 10' Banner & Hardware



8' x 8' Banner & Hardware

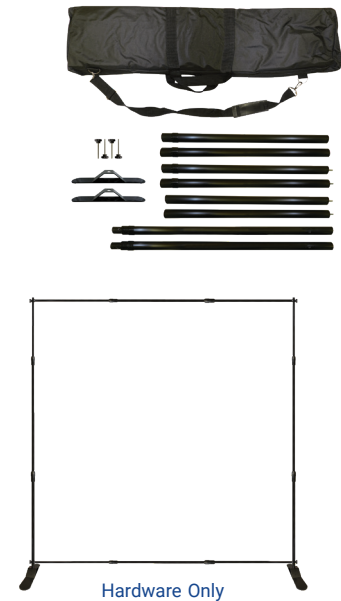

Hardware Only

\*Hardware Imported

## Collaboration Stations



Integrate technology into your trade show with this innovative and convenient product. This tablet stand is perfect for enhancing your brand and displaying the perfect message.

**Material:** Premium Polyester

**Usage:** Indoors

**Production time:** 7–10 business days

**Finish:** Zipper enclosure

**Made in USA:** No

**Prop 65 WARNING:** Cancer and/or

Reproductive Harm. [www.P65Warnings.ca.gov](http://www.P65Warnings.ca.gov)

Perfect for iPads or other tablets; the adjustable clamps allow you to easily display your gadget of choice. Accessories include: snap lock aluminum hardware, adjustable tablet clamp, anti-theft security lock, two screen gloves and black carry case.

Item	Size	1	3	6	12
TS-5015K	50" H x 15" 1/4 L x 22" W	484.85	342.40	299.50	276.00

## Window Static Clings



Outside Clings



Inside Clings



**Markets:** Retail, Restaurants, Businesses, Schools, Financial, Auto Dealerships

**Uses:** Store Windows, School Bookstores

*These reusable static clings are the perfect way to advertise without the use of tape or other forms of adhesive.*

Material: PVC  
 Usage: Outdoors / Indoors  
 Production time: 7–10 business days  
 Finish: Cut edges  
 Made in USA: No  
 Prop 65 WARNING: Cancer and/or Reproductive Harm. [www.P65Warnings.ca.gov](http://www.P65Warnings.ca.gov)

Outside						
Item	Size	100	250	500	1000	2500
WSC-560	5" x 6"	11.30	5.15	2.75	1.65	1.05
WSC-680	6" x 8"	11.40	5.40	3.00	1.90	1.30
WSC-8120	8" x 12"	12.85	5.95	3.55	2.40	1.70

R

Inside						
Item	Size	100	250	500	1000	2500
WSC-56I	5" x 6"	11.30	5.15	2.75	1.65	1.05
WSC-68I	6" x 8"	11.40	5.40	3.00	1.90	1.30
WSC-812I	8" x 12"	12.85	5.95	3.55	2.40	1.70

R

## Stretch Door Runners

**Markets:** Retail, Schools, Sports Businesses, Safety, Organizations, Financial, Healthcare, Real Estate

**Uses:** Branding, Advertising, Seminars, Conferences, Decorating

*Looking for a unique promotional item? We've got you covered with this stretch door runner!*

Material: Stretch Polyester  
 Usage: Indoors  
 Production time: 7–10 business days  
 Finish: Hemmed edges  
 Made in USA: Yes



This runner slides perfectly on your door leaving enough room for the door knob.

Door Runner						
Item	Size	1	3	6	12	25
SDR-24	24" for Doors up to 24" x 80"	159.10	117.05	95.95	76.40	69.25
SDR-30	30" for Doors up to 30" x 80"	161.90	126.50	102.90	85.80	78.20

R



## Spring Walls

**Markets:** Trade Shows, Retail, Schools, Sports, Businesses, Safety, Organizations, Financial, Healthcare

**Uses:** Branding, Advertising, Seminars, Conferences, Events

*Easy. Versatile. Lightweight. A must for anyone in need of a professional looking display that takes seconds to set up.*

**Material:** Premium Display Polyester

**Usage:** Indoors

**Production time:** 7–10 business days

**Finish:** Sewn around the edges

**Made in USA:** Yes

**Prop 65 WARNING:** Cancer and/or

Reproductive Harm. [www.P65Warnings.ca.gov](http://www.P65Warnings.ca.gov)

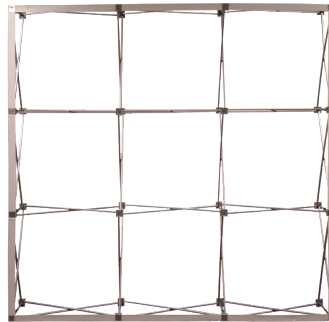

Small Kits - Size 88.5" x 31" - Carrying Bag Included						
Item	Product	1	3	6	12	24
POP-2001T1K	Banner & Hardware	736.16	569.83	499.42	460.59	429.77
POP-2001T1R	Replacement Banner	380.93	296.19	226.23	190.17	176.21

R

Medium Kits - Size 89.25" x 89.25" - Carrying Bag Included						
Item	Product	1	3	6	12	24
POP-2001T2K	Banner & Hardware	870.50	644.88	564.71	523.83	489.15
POP-2001T2R	Replacement Banner	589.30	388.71	325.75	303.06	281.47

R

## Spring Wall Curved Kits

This slightly curved display totals 135.4" x 89.5". Five PVC panels connect to hardware via hanging hardware and magnetic strips attached to the display hardware. Carrying bag included.

Item	Product	1	3	6	12	24
POP-2001T3K	Banner & Hardware	847.98	599.17	574.82	546.39	496.67
POP-2001T3R	Replacement Banner	538.10	388.22	316.27	301.29	271.01

R

**Material:** Polyethylene

**Usage:** Indoors

**Production time:** 7–10 business days

**Finish:** 5 PVC sections affixed to

panels and hardware

**Made in USA:** No

**Prop 65 WARNING:** Cancer and/or

Reproductive Harm. [www.P65Warnings.ca.gov](http://www.P65Warnings.ca.gov)



\*Hardware Imported

## Retractable Banner Stands



*This sleek and stylish banner stand is the best value retractable frame anywhere! Assemble without tools and features a satin silver finish.*

**Material:** 200G Polyester  
**Usage:** Indoors  
**Production time:** 7-10 business days  
**Finish:** Mounted to aluminum frame  
**Made in USA:** No  
**Prop 65 WARNING:** Cancer and/or Reproductive Harm. [www.P65Warnings.ca.gov](http://www.P65Warnings.ca.gov)

Item	Size	1	3	6	12
RBS-2463	24" x 63"	314.00	195.00	154.90	115.00
RBS-3236	32" x 36"	307.00	204.50	164.50	126.20
RBS-3248	32" x 48"	308.00	205.50	165.50	127.20
RBS-3260	32" x 60"	310.00	207.50	167.50	129.20
RBS-3279	32" x 79"	354.90	259.50	188.00	154.50

- **Lightweight**
- **Portable**
- **Instant Set-Up**
- **Easy Take Down**
- **Tool Free Assembly**

## Easy A-Frames



**Markets:** Retail, Businesses, Sports, Shopping Malls, Healthcare, Schools

**Uses:** Event Messaging, Awareness, Direction, Advertising, Festivals

*Use more than one to create a pathway, barrier or sideline. Note: the digitally printed sides can be printed with any image including two identical images, two different images, or background color on one side and your image on the other!*

**Material:** Stretch Polyester  
**Usage:** Outdoors / Indoors  
**Production time:** 7-10 business days  
**Finish:** Hemmed on bottom  
**Made in USA:** Yes  
**Prop 65 WARNING:** Cancer and/or Reproductive Harm. [www.P65Warnings.ca.gov](http://www.P65Warnings.ca.gov)



Accessories include 6 metal stakes and black carrying bag.

Easy A-Frame Kit ( Includes Hardware )						
Item	Length	1	3	6	12	25
EADF-2001T2K	85" L x 24" W x 36" H	496.68	362.43	337.08	295.59	284.64

Easy A-Frame Replacement Banner						
Item	Length	1	3	6	12	25
EADF-2001T2R	85" L x 24" W x 36" H	266.51	216.06	163.16	140.28	125.90

\*Hardware Imported



# SlimFit Displays

**Markets:** Trade Shows, Retail, Schools, Sports, Businesses, Safety, Organizations, Financial, Healthcare

**Uses:** Branding, Advertising, Seminars, Conferences, Events

*Sleek. Easy. Versatile. Lightweight. These aluminum tube-frame displays are a must for anyone in need of a professional looking backdrop that takes seconds to set up.*

Material: Stretch Polyester / Display Polyester  
 Usage: Indoors  
 Production time: 7-10 business days  
 Finish: Sewn around the edges  
 Made in USA: Yes



- Lightweight Aluminum Frame
- Set Up Takes Minutes



## SlimFit Wall

At 94.5" x 91" this SlimFit Display Wall offers a seamless-end presentation. Includes black carrying bag.

Item	Product	1	3	6	12	24
SLBW-2001T2K	Banner & Hardware	793.80	605.98	540.87	502.73	474.32
SLBW-2001T2R	Replacement Graphic	588.12	414.34	360.84	338.80	316.85

## SlimFit Steel Base

The black steel base allows this 37.5" x 90" display with a small foot-print. Includes black carrying bag.

Item	Product	1	3	6	12	24
SLBSB-2001T2K	Banner & Hardware	330.00	313.50	300.00	285.00	275.00
SLBSB-2001T2R	Replacement Graphic	240.00	228.00	205.00	183.75	165.00



## SlimFit Ribbon

This 39" x 83" display offers a unique and edgy idea that can be used in all kinds of spaces. Includes black carrying bag.

Item	Product	1	3	6	12	24
SLRB-2001T2K	Banner & Hardware	796.00	506.97	426.97	356.85	329.72
SLRB-2001T2R	Replacement Graphic	436.37	257.43	205.67	168.92	149.21



## Accessories



Visit [WWW.QUINNFLAGS.COM](http://WWW.QUINNFLAGS.COM) for Accessories

\*Hardware Imported

## X-Banner Kits



Pack up and go with ease with all of the necessary hardware and a black carrying case for easy transportation. A simple solution for any event.

**Material:** Premium Display Polyester  
**Usage:** Indoors  
**Production time:** 7-10 business days  
**Finish:** Hemmed edges / reinforced grommets in each corner  
**Made in USA:** Yes  
**Prop 65 WARNING:** Cancer and/or Reproductive Harm. [www.P65Warnings.ca.gov](http://www.P65Warnings.ca.gov)



Item	Size	Product	1	3	6	12	25
XBS-3174	30.5" x 74"	Banner & Hardware	272.00	185.50	150.00	113.95	94.20
XBR-3174	30.5" x 74"	Replacement Banner	132.50	100.00	73.20	51.50	40.00
XBS-2001T2K	24" x 60"	Banner & Hardware	207.56	109.37	79.63	66.59	51.48
XBS-2001T2R	24" x 60"	Replacement Banner	177.16	87.84	56.05	45.77	35.03
XBS-2002T2K	31" x 60"	Banner & Hardware	214.32	115.63	89.27	74.53	57.50
XBS-2002T2R	31" x 60"	Replacement Banner	183.92	94.60	63.58	54.28	39.26

R

## Mini X-Banner Kits



Simple. Fast. Affordable. The Mini X-Banner is an ideal solution to include in any trade show or conference as a quick desktop or counter POP/Retail display.

**Material:** Premium Satin  
**Usage:** Indoors  
**Production time:** 7-10 business days  
**Finish:** Heat cut edges  
**Made in USA:** Yes  
**Prop 65 WARNING:** Cancer and/or Reproductive Harm. [www.P65Warnings.ca.gov](http://www.P65Warnings.ca.gov)



Item	Length	Product	1	3	6	12	24
MXBS-2001T1K	7.75" x 16.50"	Banner & Hardware	38.97	32.48	28.64	26.33	19.87
MXBS-2001T1R	7.75" x 16.50"	Replacement Banner	19.47	16.23	14.32	13.15	9.93

R

## Tower Stands



Modern. Easy. Versatile. Lightweight. This Stretch Polyester Tower Stand is a fantastic addition to our products line.

**Material:** Stretch Polyester  
**Usage:** Indoors  
**Production time:** 7-10 business days  
**Finish:** Hemmed edges  
**Made in USA:** Yes  
**Prop 65 WARNING:** Cancer and/or Reproductive Harm. [www.P65Warnings.ca.gov](http://www.P65Warnings.ca.gov)



Item	Product	1	3	6	12	25
TSFC-7	Full Curve Kit	493.49	351.14	326.58	286.38	275.78
TSPC-7	Pointed Curve Kit	493.49	351.14	326.58	286.38	275.78
TSFC-7R	Full Curve Replacement Banner	246.56	199.89	150.95	129.78	116.47
TSPC-7R	Pointed Curve Replacement Banner	246.56	199.89	150.95	129.78	116.47

R

\*Hardware Imported



# Backpack Flags

**Markets:** Trade Shows, Sports, Schools, Businesses, Political

**Uses:** Mobile Advertising, Festivals, Events, Branding

Create a truly mobile promo with a backpack flag. Perfect for use both indoors and out and assembles in minutes with no additional tools required. Backpack included!

**Material:** Polyester  
**Usage:** Outdoors / Indoors  
**Production time:** 7-10 business days  
**Finish:** Black nylon pole sleeve  
**Made in USA:** Yes  
**Prop 65 WARNING:** Cancer and/or Reproductive Harm. www.P65Warnings.ca.gov



- Assembles in Minutes
- No Additional Tools Required

Single Reverse reads correct on one side and reversed on the backside. Double Sided reads correct on both sides and has a block-out liner in the center.

Single Reverse							
Item	Height	Shape	6	12	25	50	100
BPF-1631R	31.5"	Rectangle	139.85	111.89	100.70	90.64	81.57
BPF-1941S	38.75"	Half Drop w/ Scallop	139.85	111.89	100.70	90.64	81.57
BPF-2048H	48"	Half Drop	139.85	111.89	100.70	90.64	81.57
BPF-2440T	39"	Teardrop	139.85	111.89	100.70	90.64	81.57

Double Sided							
Item	Height	Shape	6	12	25	50	100
BPF-D1631R	31.5"	Rectangle	155.35	124.29	111.87	100.67	90.60
BPF-D1941S	38.75"	Half Drop w/ Scallop	155.35	124.29	111.87	100.67	90.60
BPF-D2048H	48"	Half Drop	155.35	124.29	111.87	100.67	90.60
BPF-D2440T	39"	Teardrop	155.35	124.29	111.87	100.67	90.60



Economy backpack also available!  
 Contact us for details.

\*Hardware Imported

# Pop-Up Banners

**Markets:** Retail, Businesses, Sports, Shopping Malls, Healthcare, Schools

**Uses:** Event Messaging, Awareness, Direction, Advertising, Festivals

Reach for the sky during your next promotional campaign with these pop-up banners!

**Material:** Premium Display Polyester  
**Usage:** Indoors / Temporary Outdoors  
**Production time:** 7-10 business days  
**Finish:** Sewn around the edges  
**Made in USA:** No  
**Prop 65 WARNING:** Cancer and/or Reproductive Harm. www.P65Warnings.ca.gov

- Highly Visible
- Cost Effective
- Portable
- Indoor & Outdoor Use
- Lightweight



Circle

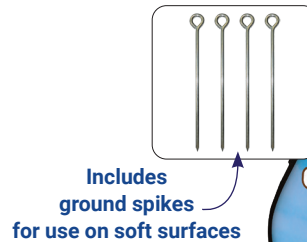

Includes ground spikes for use on soft surfaces



Triangle

Triangle						
Item	Size	1	3	6	12	25
POPT4747	47.25" x 47.25"	381.95	256.20	210.85	171.55	163.55
POPT5959	59" x 59"	454.65	317.15	265.00	223.50	202.10

Circle						
Item	Size	1	3	6	12	25
POPC39	39.37" x 39.37"	312.65	202.25	163.25	128.55	114.10
POPC47	47.25" x 47.25"	403.65	276.45	228.50	185.20	173.85
POPC59	59" x 59"	442.25	306.30	255.30	214.55	193.55

Vertical						
Item	Size	1	3	6	12	25
POPV2335	23.62" x 35.43"	309.90	196.10	157.85	128.55	114.10
POPV3966	39.37" x 66.9"	348.15	268.80	218.20	173.40	159.25
POPV4978	49.2" x 78.75"	457.75	322.80	268.80	226.95	206.75

Horizontal						
Item	Size	1	3	6	12	25
POP4727	47" x 27.55"	308.00	190.90	170.50	132.50	118.00
POP7939	78.75" x 39.4"	380.00	302.50	237.90	182.70	165.00
POP43102	43" x 102"	470.00	331.50	275.60	242.20	220.00



Vertical



Horizontal

## InstaStands

- Quick Set Up
- Base Holds Up To 35 LBS
- Easy Set-Up & Take Down



InstaStands display themselves with pneumatic hardware!

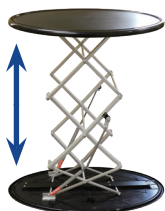

**Markets:** Trade Shows, Retail, Schools, Sports, Businesses, Safety, Organizations, Financial, Healthcare

**Uses:** Branding, Advertising, Seminars, Conferences, Events

*Pack up and go with ease with all of the necessary hardware and a black carrying case for easy transportation. A simple solution for any pop-up meeting.*

**Material:** Stretch Polyester  
**Usage:** Indoors  
**Production time:** 7-10 business days  
**Finish:** Sewn around the edges  
**Made in USA:** No  
**Prop 65 WARNING:** Cancer and/or Reproductive Harm. [www.P65Warnings.ca.gov](http://www.P65Warnings.ca.gov)

Item	Product	1	3	6	12	24
ARTS-3001T2K	InstaStand Hardware & Banner	496.86	444.90	431.76	412.30	393.99
ARTS-3001T2R	InstaStand Replacement Graphic	167.96	130.27	120.37	108.98	95.44

R

## Transformer Trunk Kits



Storage trunk compartment for marketing materials, samples & much more!



**Markets:** Trade Shows, Retail, Schools, Sports, Businesses, Safety, Organizations, Financial, Healthcare

**Uses:** Branding, Advertising, Seminars, Storage

*From traveling case to table stand in just a few easy steps, the Transformer Trunk is perfect for a single representative to set up. The possibilities for storage are endless!*

**Material:** Stretch Polyester  
**Usage:** Indoors  
**Production time:** 7-10 business days  
**Finish:** Hemmed edges  
**Made in USA:** No  
**Prop 65 WARNING:** Cancer and/or Reproductive Harm. [www.P65Warnings.ca.gov](http://www.P65Warnings.ca.gov)

Item	Product	1	3	6	12
TTTS-3001T2K	Banner & Hardware	456.25	424.33	394.88	367.75
TTTS-3001T2R	Replacement Graphic	169.81	124.88	114.74	80.10

R

## Custom Display Tables



*Add some professional flair with a portable and lightweight table that's built to deliver.*

**Material:** Plastic / PVC  
**Usage:** Indoors  
**Production time:** 10 business days  
**Finish:** Solid white backing on top and bottom panels  
**Made in USA:** No  
**Prop 65 WARNING:** Cancer and/or Reproductive Harm. [www.P65Warnings.ca.gov](http://www.P65Warnings.ca.gov)

Item	Size	1	3	6	12	25
DTPOP-01	80" Tall	356.27	295.47	261.64	224.07	206.30

R

\*Hardware Imported



## Illuminator InstaStand Kits

**Markets:** Trade Shows, Retail, Schools, Sports, Businesses, Safety, Organizations, Financial, Healthcare

**Uses:** Branding, Advertising, Seminars, Conferences, Events

The lights on this InstaStand Table will make your graphic come to life! Set up in 3 seconds or less! The InstaStand Table Stand quickly goes from in case to set up without the need to remove the banner!

**Material:** GlowTec Fabric  
**Usage:** Indoors  
**Production time:** 7-10 business days  
**Finish:** Hemmed edges  
**Made in USA:** No  
**Prop 65 WARNING:** Cancer and/or Reproductive Harm. [www.P65Warnings.ca.gov](http://www.P65Warnings.ca.gov)



Item	Product	1	3	6	12
ARTS-3001T3K	Illuminator InstaStand Light Up Table Kit	660.65	627.65	596.25	566.50
ARTS-3001T3R	Illuminator InstaStand Graphic Replacement	142.50	104.85	96.30	70.00

R

## Illuminator Display Kits

New and innovative way to get your brand noticed. The kit includes an aluminum frame, LED curtain light system and a full color attention-grabbing graphic.

**Material:** GlowTec Fabric  
**Usage:** Indoors  
**Production time:** 7-10 business days  
**Finish:** Sewn around the edges  
**Made in USA:** No  
**Prop 65 WARNING:** Cancer and/or Reproductive Harm. [www.P65Warnings.ca.gov](http://www.P65Warnings.ca.gov)

**L.E.D.**



Item	Product	Size	1	3
SEGOPP-23K	5' Illuminator Kit	59.5" x 88.5"	1942.65	1520.10
SEGOPP-23R	GlowTec Fabric Replacement Graphic	59.5" x 88.5"	925.70	565.65
SEGOPP-33K	7' Illuminator Kit	88.5" x 88.5"	2215.90	1956.90
SEGOPP-33R	GlowTec Fabric Replacement Graphic	88.5" x 88.5"	1008.80	636.55

R



## Trade Show Packages

**Markets:** Trade Shows, Schools, Sports, Businesses

**Uses:** Branding, Advertising, Seminars, Conferences

Your Trade Show Booth display design made easy. Are you looking for a one-stop-shop alternative to sifting through all the choices and combinations of products available? Let us do the work for you!

- Save Over 15%
- 4 Packages to Choose From

**Material:** Premium Polyester / Premium Display Polyester / Knit Polyester  
**Usage:** Indoors  
**Production time:** 7-10 business days  
**Finish:** Sewn around the edges  
**Made in USA:** Yes  
**Prop 65 WARNING:** Cancer and/or Reproductive Harm. www.P65Warnings.ca.gov



### Starter Package

Item	1	3
TPZ-5001T1Z	876.40	832.50

Package Includes:

- Throw Style Table Cover for 6' Table (DTC-6F)
- X-Banner Kit (XBS-3174)
- 8' x 8' Backdrop Banner Kit (BBSS-200)

Trade Shows are crowded...

## Stand Out



### Basic Package

Item	1	3
TPZ-5002T1Z	1123.90	1067.70

Package Includes:

- Throw Style Table Cover for 6' Table (DTC-6F)
- X-Banner Kit (XBS-3174)
- 8' x 8' Backdrop Banner Kit (BBSS-200)
- Portable Double Sided Teardrop with Hardware and Cross Base (PTB-D8KC)

\*Hardware Imported





Sleek Package

Item	1	3
TPZ-5003T1Z	1665.25	1557.20

Package Includes:

- Stretch Style Table Cover for 6' Table (DTSC-6)
- SlimFit Steel Base Kit (SLBSB-2001T2K)
- SlimFit Wall Kit (SLBW-2001T2K)
- InstaStand (ARTS-3001T2K)



Superior Package

Item	1	3
TPZ-5004T1Z	1900.00	1750.00

Package Includes:

- Stretch Style Table Cover for 6' Table (DTSC-6)
- SlimFit Steel Base Kit (SLBSB-2001T2K)
- SlimFit Wall Kit (SLBW-2001T2K)
- InstaStand (ARTS-3001T2K)
- X-Banner Kit ( XBS-3174)
- Mini X-Banner Kit (MXBS-2001T1K)

All packages include: Display hardware system, applicable banners/flags shown and accessories included with each individual product. Table not included. Due to the differences in fabric materials, packages may include products with slight color variations.

\*Hardware Imported

## Booth in a Box

**Markets:** Trade Shows, Schools, Businesses

**Uses:** Branding, Advertising, Seminars, Conferences

*Introducing your entire Trade Show Booth... In A Box!  
One person can easily transport their entire booth display because all hardware and graphics fit INSIDE one wheeled display.*

# Booth in a Box



**Material:** Premium Display Polyester, Premium Polyester, Premium Satin, Stretch Polyester, Knit Polyester  
**Usage:** Indoors  
**Production time:** 7-10 business days  
**Finish:** Sewn around the edges, Mini X-Banner features heat-cut edges  
**Made in USA:** Yes  
**Prop 65 WARNING:** Cancer and/or Reproductive Harm. www.P65Warnings.ca.gov

All hardware and graphics can be stored and transported **INSIDE** one display *with wheels!*



### Booth in a Box Package A

Item	1
BIB-A	1331.67
	R

**Package Includes:**

- Transformer Trunk (TTTS-3001T2K)
- Medium Spring Wall (POP-2001T2K)
- X-Banner (XBS-3174)
- 6' Stretch Table Cover (DTCS-6)
- 2 Mini X-Banner Kits (MXBS-2001T1K)



### Booth in a Box Package B

Item	1
BIB-B	1415.00
	R

**Package Includes:**

- Transformer Trunk (TTTS-3001T2K)
- Tower Stand w/Pointed Curve (TSPC-7)
- 6' Portable Teardrop Banner w/Cross Base (PTB-6KC)
- 2 Mini X-Banner Kits (MXBS-2001T1K)
- 6' Throw Table Cover (DTC-6F)
- 7'x8' Pipe & Drape Backdrop Banner (BBPD-87)

Due to the differences in fabric materials, packages may include products with slight color variations. \*Hardware Imported



# NEW BOOTH IN A BOX!

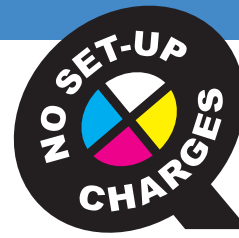

## Booth in a Box Package C

Item	1
BIB-C	1665.00

R

### Package Includes:

- Transformer Trunk (TTTS-3001T2K)
- X-Banner Kit (XBS-3174)
- 2 Mini X-Banner Kits (MXBS-2001T1K)
- 6' Portable Teardrop Banner w/ Cross Base (PTB-6KC)
- 6' Stretch Table Cover (DTCS-6)
- SlimFit Wall w/2 LED Clip Lights (SLBW-2001T2K / SLLA-5000T2)



## Booth in a Box Package D

Item	1
BIB-D	1831.67

R

### Package Includes:

- Transformer Trunk (TTTS-3001T2K)
- Tower Stand w/Pointed Curve (TSPC-7)
- 6' Throw Table Cover (DTC-6F)
- Collaboration Station (TS-5015K)
- 2 Mini X-Banner Kits (MXBS-2001T1K)
- 39.37" Circle Pop-Up Banner (POPC39)
- 7'x8' Pipe & Drape Backdrop Banner (BBPD-87)



Trunk features a handle and integrated wheels for easy transport



Heavy duty straps hold trunk (and packaged displays) in one display



Most displays include their own bag



## American Flags and Stock Products

### *Show your Patriotism everywhere and anywhere!*

**When determining which American Flag & Stock Product best suits your client's needs...**

**Where will it be used?** – We provide different materials for indoor or outdoor use. Choosing the right material for the correct use for your client's needs shows that you are the expert!

**How will it be used/displayed?** – Flags can be displayed many ways; off a building, on a flag pole, on a wall, etc... we have stock hardware options that can best meet your client's needs.

**How should messaging be presented?** – There are options for messaging on the heading of flags, imprinted staffs and customized packaging!

**What size?** – Displaying the American flag with other flags includes specific etiquette rules that should be followed. If displayed on separate hardware, the flags should all be the same size except the American flag should always be to the left of the viewer. If multiple flags are displayed vertically, the American flag should be 1 size larger than the other flags.



## Patriotic American Flag Products

### Economy Cotton U.S. Stick Flags



**Please Inquire for Imprint  
on Wooden Staffs  
Up to 40  
Characters of Text**

**Markets:** Organizations, Businesses, Political, Sports

**Uses:** Parades, Patriotic, Giveaways, Decoration

*Wave a traditional promotion at your next event with a cotton U.S. stick flag on a dowel!*

**Material:** Cotton  
**Usage:** Outdoors  
**Production time:** Stock item  
**Finish:** Mounted to a wooden dowel  
**Made in USA:** Yes



Item	Flag size	Staff size	1	12	144	1440
EC-46	4' x 6"	10"	0.40	0.35	0.30	0.26
EC-69	6' x 9"	18"	0.84	0.76	0.68	0.64
EC-812	8' x 12"	24"	1.22	1.10	0.98	0.88
EC-1218	12' x 18"	30"	1.49	1.39	1.24	1.18

U

### Heavy Duty Pleated Fans



**Markets:** Organizations, Businesses, Political, Sports

**Uses:** Patriotic, Decoration

*Create the right promotional display for any event with these striped pleated fans.*

**Material:** Polyester  
**Usage:** Outdoors  
**Production time:** Stock item  
**Finish:** Sewn around the edges  
**Made in USA:** No  
**Prop 65 WARNING:** Cancer and/or Reproductive Harm. [www.P65Warnings.ca.gov](http://www.P65Warnings.ca.gov)

Our most popular and most durable Pleated Fans feature appliqué sewn stars and stripes. Made of durable, heavyweight polyester material and finished with canvas heading and grommets.

Heavy Duty Pleated Fans					
Item	Size	Material	1	12	25
PFF-527	27" x 54"	Heavyweight Polyester	18.50	17.90	16.90
PFF-536	3' x 6'	Heavyweight Polyester	37.50	35.00	33.25
PFF-548	4' x 8'	Heavyweight Polyester	34.50	32.50	29.50
PFF-551	5' x 10'	Heavyweight Polyester	39.50	36.50	35.00

U

### Cotton Pleated Fans



**Material:** Cotton  
**Usage:** Outdoors  
**Production time:** Stock item  
**Finish:** Sewn around the edges  
**Made in USA:** No  
**Prop 65 WARNING:** Cancer and/or Reproductive Harm. [www.P65Warnings.ca.gov](http://www.P65Warnings.ca.gov)

Constructed out of cotton, these printed Pleated Fans feature 5 stripes with stars. Excellent for short term use.

Cotton Pleated Fans					
Item	Size	Material	1	6	
PFF-501	18" x 36"	Printed Cotton	14.95	13.50	
PFF-502	3' x 6'	Printed Cotton	22.95	20.75	
PFF-503	4' x 8'	Printed Cotton	53.00	50.00	

U

## U.S. Nylon Flags



**Markets:** Used In All Markets

**Uses:** Patriotic, Flagpole Display, Building Display

*Display some stars and stripes during your next marketing campaign with our outdoor nylon flags.*

**Material:** Nylon  
**Usage:** Outdoors  
**Production time:** Stock item  
**Finish:** Sewn around the edges  
**Made in USA:** Yes



Our popular nylon American Flags are versatile and long lasting. Constructed from a durable 200 denier Dupont™ nylon, each flag features sewn stripes, embroidered stars and is fully hemmed with additional reinforced stitching on the fly end for support and longevity.

Item	Size	Finishing	1	2	6
NF-120	2' x 3'	Heading & Grommets	22.50	21.90	20.00
NF-135	3' x 5'	Heading & Grommets	21.20	20.40	18.80
NF-145	4' x 6'	Heading & Grommets	36.20	29.60	28.40
NF-150	5' x 8'	Heading & Grommets	48.40	47.20	46.00
NF-155	5' x 9.5'	Heading & Grommets	58.10	57.50	56.90
NF-160	6' x 10'	Heading & Grommets	72.60	71.40	70.20
NF-165	8' x 12'	Rope & Thimble	156.70	153.10	148.30
NF-170	10' x 15'	Rope & Thimble	187.60	186.40	184.00
NF-175	10' x 19'	Rope & Thimble	229.90	228.70	227.40
NF-180	12' x 18'	Rope & Thimble	268.80	267.50	266.30
NF-185	15' x 25'	Rope & Thimble	392.20	391.00	389.90

U

## 2-Ply Polyester Flags



*Show your American pride during the holidays, paying tribute to the Armed Forces or simply putting your patriotism on display.*

**Material:** Polyester  
**Usage:** Outdoors  
**Production time:** Stock item  
**Finish:** Sewn around the edges  
**Made in USA:** Yes

Our 2-ply polyester American Flags are long lasting and great for windy outdoor conditions. Constructed from a durable 2-ply woven polyester, each flag features sewn stripes, embroidered stars and is fully hemmed with additional reinforced stitching on the fly end for support and longevity.

Item	Size	Finishing	1	2	6
PF-105	3' x 5'	Heading & Grommets	29.00	27.80	26.60
PF-110	4' x 6'	Heading & Grommets	39.90	38.20	36.20
PF-115	5' x 8'	Heading & Grommets	64.10	60.40	58.00
PF-120	5' x 9.5'	Heading & Grommets	87.10	85.80	84.60
PF-125	6' x 10'	Heading & Grommets	96.20	93.80	90.20
PF-130	8' x 12'	Rope & Thimble	180.95	178.50	174.60
PF-135	10' x 15'	Rope & Thimble	241.90	239.60	235.90
PF-140	10' x 19'	Rope & Thimble	317.50	314.00	306.50
PF-145	12' x 18'	Rope & Thimble	317.10	311.20	299.80
PF-150	15' x 25'	Rope & Thimble	569.95	568.75	567.50

U



# U.S. Promotional Printed Poly / Cotton Flags and Home Sets

**Markets:** Businesses, Residential, Organizations

**Uses:** Giveaways, Patriotic, Building Display

*Durable yet inexpensive, these outdoors flags are made of a durable printed polyester/cotton material with 2-needle stitching and sturdy heading and grommets.*

**Material:** Polyester / Cotton  
**Usage:** Outdoors  
**Production time:** Stock item  
**Finish:** Sewn around the edges  
**Made in USA:** Yes  
**Prop 65 WARNING:** Cancer and/or Reproductive Harm. [www.P65Warnings.ca.gov](http://www.P65Warnings.ca.gov)



Item	Size	1	12	48	144
PCF-35	3' x 5' American Flag**	11.99	9.59	7.67	6.52

\*Hardware Imported  
 \*\* Shipped Bulk Package

## Message Flags and Flagpoles

**Markets:** Businesses, Real Estate, Construction, Restaurants

**Uses:** Messaging, Flagpole Display

*Create something that's perfect for any store front with these 3' x 5' message flags. Designed with a red top border and a blue bottom border with the size and look that will attract business!*

**Material:** Polyester  
**Usage:** Outdoors  
**Production time:** 7-10 business days  
**Finish:** Sewn around the edges  
**Made in USA:** Yes  
**Prop 65 WARNING:** Cancer and/or Reproductive Harm. [www.P65Warnings.ca.gov](http://www.P65Warnings.ca.gov)



Item	Size	Material	1	12
A-6105	3' x 5'	Open Flag	23.95	22.50
A-6100	3' x 5'	Welcome Flag	23.95	22.50
ADP-800CS	8'	Outdoor Display Flagpole*	19.98	18.98
MSO-899	8'	8' Indoor Telescopic Flagpole*	44.90	39.50

\*Hardware Imported

## Aluminum Flagpoles

Comes with a 2" diameter pole, die-cast aluminum cleats, durable halyard rope, 3/8" nylon snap hooks, 2" cast aluminum truck with nylon pulley, PVC ground sleeve and 3" gold anodized aluminum ball.

Item	Size	Color	Flag included	Style	1
AFP-16	16'	Silver	No	Sectional	109.50
AFP-20	20'	Silver	No	Sectional	94.50
AFP-20-WHITE	20'	White	No	Sectional	99.95
AFP-25F	25'	Silver	Yes	Sectional	139.90

Our "top of the line" and most durable aluminum flagpole features a spring release button to extend or retract the pole in seconds. Measuring at 20' at its maximum length and 70" when collapsed makes it ideal for a wide variety of occasions. Includes ground sleeve. Flag not included.

Item	Size	Color	Flag included	Style	1
RTF-120	20'	Satin Finish	No	Telescoping	99.50



Prop 65 WARNING: Cancer and/or Reproductive Harm. [www.P65Warnings.ca.gov](http://www.P65Warnings.ca.gov)

## Historical and Military Flags



**Markets:** Businesses, Organizations, Municipal, Financial

**Uses:** Flagpole Display, Indoor Display, Patriotic

Material: Polyester / Nylon  
 Usage: Outdoors  
 Production time: 3–5 business days  
 Finish: Sewn around the edges  
 Made in USA: Yes



Many styles and sizes available. See website for prices or contact us.

## State / International Flags



**Markets:** Historic Associations, Patriotic

**Uses:** Holiday Parades, Museums, Patriotic Events

Material: Polyester / Nylon  
 Usage: Outdoors  
 Production time: 3–5 business days  
 Finish: Sewn around the edges  
 Made in USA: Yes



## Indoor Sets and Hardware

Soar high above the competition with our oak pole indoor mounting set with a spear or Eagle top!

Material: Plastic / Wood / Brass  
 Usage: Indoors  
 Production time: 3–5 business days  
 Made in USA: No  
 Prop 65 WARNING: Cancer and/or Reproductive Harm. www.P65Warnings.ca.gov



Indoor Display Set with Eagle Topper		
Item	Size	1
MSO-497	7' x 1 1/4"	115.00
MSO-550	8' x 1 1/4"	120.00
MSO-560	9' x 1 1/4"	125.00

Indoor Display Set with Spear Topper		
Item	Size	1
MSO-498	7' x 1 1/4"	115.00
MSO-499	8' x 1 1/4"	120.00
MSO-561	9' x 1 1/4"	125.00

## Staff Mounted State Rayon Flags

Celebrate the feeling of unity with this stand-out set of 50 4" x 6" staff mounted state flags!

Material: Rayon  
 Usage: Indoors  
 Production time: 5–7 business days  
 Made in USA: Yes



State Rayon Flag Sets		
Item	Size	1+
CSS-46	4' x 6"	82.50



**NEW!**

**Quick Ship Products**



Half Drop



Swooper Banner



Teardrop Banner



Golf Flags



Car Flags



Knit Polyester Flag



Table Cover

**24 Hour Quick Ship**

Table Covers			
Item	Size	Style	1
DTC-6F24	6'	Throw Style	380.00
DTC-8F24	8'	Throw Style	400.00

Single Reverse Knit Polyester Flags				
Item	Size	1	3	6
DPP-2324	2' x 3'	225.00	115.00	70.70
DPP-3524	3' x 5'	250.00	141.00	95.50

*Half Drop Banners With Hardware Set				
Item	Size	Sides	1	3
PHB-6K24	6'	Single Reverse	302.95	215.10
PHB-8K24	8'	Single Reverse	317.95	233.80

*Teardrop Banners With Hardware Set				
Item	Size	Sides	1	3
PTB-6K24	6'	Single Reverse	302.95	215.10
PHB-8K24	8'	Single Reverse	317.95	233.80

*Single Reverse Car Flags				
Item	Size	6	12	25
CCFP-75S24	7.5' x 10.5'	45.20	30.50	20.30
CCFP-115S24	11.5' x 15'	59.20	40.95	31.70

Single Sided Golf Flags							
Item	Size	Finish	1	3	6	12	25
GFGS-142024	14" x 20"	Heading & Grommets	206.00	96.50	53.00	30.50	18.00
GFTS-142024	14" x 20"	With Sewn in Golf Tube*	209.00	99.50	63.00	38.00	25.60

*Swooper Banner			
Item	Size	Sides	1
SWOOP-C12K24	12'	Single Reverse	237.40

**48 Hour Quick Ship**

Table Covers			
Item	Size	Style	1
DTC-6F48	6'	Throw Style	338.35
DTC-8F48	8'	Throw Style	358.35

Single Reverse Knit Polyester Flags				
Item	Size	1	3	6
DPP-2348	2' x 3'	183.20	100.90	63.75
DPP-3548	3' x 5'	207.70	127.70	91.40

*Half Drop Banners With Hardware Set				
Item	Size	Sides	1	3
PHB-6K48	6'	Single Reverse	261.30	206.80
PHB-8K48	8'	Single Reverse	279.60	224.80

*Teardrop Banners With Hardware Set				
Item	Size	Sides	1	3
PTB-6K48	6'	Single Reverse	261.30	206.80
PHB-8K48	8'	Single Reverse	279.60	224.80

*Single Reverse Car Flags				
Item	Size	6	12	25
CCFP-75S48	7.5' x 10.5'	38.25	26.95	19.55
CCFP-115S48	11.5' x 15'	52.25	39.40	30.50

Single Sided Golf Flags							
Item	Size	Finish	1	3	6	12	25
GFGS-142048	14" x 20"	Heading & Grommets	164.20	82.40	35.80	26.85	15.80
GFTS-142048	14" x 20"	With Sewn in Golf Tube*	166.50	85.20	55.80	34.35	24.65

*Swooper Banner			
Item	Size	Sides	1
SWOOP-C1248	12'	Single Reverse	195.70

**All Made in the U.S.A!**



**QUICK SHIP GUIDELINES**

- Proofs not available
- Order must ship via UPS only.
- Product time guarantee while capacity is available.

- Quick turn items cannot be combined with regular lead time items on purchase order.
- Complete purchase order, and artwork on QUINN template, must be received by 3:00 p.m. EST.
- Factory will not be held responsible for any delays in the shipment due to discrepancies with the artwork and/or items on purchase order.
- Additional Quick Ship products are available. Visit [www.quinnflags.com](http://www.quinnflags.com) for the most up-to-date available Quick Ship products.

\*Hardware Imported

\*Prop 65 WARNING: Cancer and/or Reproductive Harm. [www.P65Warnings.ca.gov](http://www.P65Warnings.ca.gov)

# QUINN

## BEST SELLERS



OUTDOOR &  
LIGHTWEIGHT FLAGS



PORTABLE  
BANNERS



TABLE  
COVERS



PENNANT  
STRINGS



STICK  
FLAGS

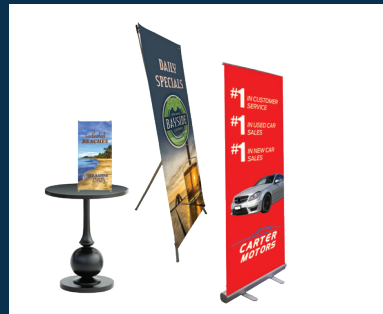

X-BANNERS &  
RETRACTABLE BANNERS



FELT  
PENNANTS



CAR  
FLAGS



TENTS



Follow us on

